

Circa | Modular Seating

DESIGN ALISON SPEAR, AIA DESIGN ORIGIN: UNITED STATES

Tip: These colors are different than other Coalesse powder coats.

Tip: Recommended leathers: are Tulsa Grade C or Dorado Grade E.

Tip: Special color match, consult customer service.

Tip: Certain fabrics and leathers will appear loose with comfort wrinkles when upholstered.

Tip: Pricing based on highest grade textile specified.

Tip: Contrasting option not available on benches.

Tip: Optional steel leg has 90° corner taper shape.

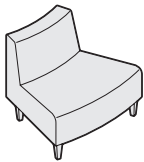

Overall: 28"D 36¾"W 29½"H
 Inside: 20"D 36¾"W 12¼"H
 Seat: 17¼"H
 Angle Degree: 30°



Overall: 28"D 36¾"W 29½"H
 Inside: 20"D 36¾"W 12¼"H
 Seat: 17¼"H
 Angle Degree: 30°

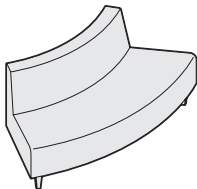

Overall: 28"D 71"W 29½"H
 Inside: 20"D 71"W 12¼"H
 Seat: 17¼"H
 Angle Degree: 60°

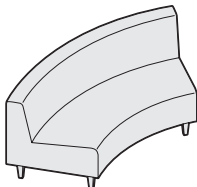

Overall: 28"D 71"W 29½"H
 Inside: 20"D 71"W 12¼"H
 Seat: 17¼"H
 Angle Degree: 60°

Standard Includes	Required to Specify
-------------------	---------------------

<ul style="list-style-type: none"> • Frame: unibody construction of hardwood plywood utilizing box joinery • Upholstery: multiple densities of polyurethane foam fixed seat and back with top stitch on seams • Legs: hardwood maple or walnut 	<ol style="list-style-type: none"> 1 Style number 2 Number of fabrics if contrasting fabric style number is selected 3 Fabric or leather color number for upholstery on seat and back 4 Wood color number for legs 5 Options, if selected (see below) <p>► See <i>Surface Materials</i>, page 420.</p>
---	---

Options	U.S. Price	Required to Specify
---------	------------	---------------------

Surface Materials <ul style="list-style-type: none"> • Contrasting Fabric 	+\$105 per fabric	Add suffix K to the style number and select fabric color number.
Metal Legs <ul style="list-style-type: none"> • Powder coat steel legs 	+\$115 per leg	Specify <i>with powder coat steel legs</i> and specify color number: Black Gloss, Gunmetal, Silver Gloss, White Gloss.

Specification Information

Style Number	U.S. Base Prices														Leather Grades:		
	Fabric Grades:														COL	C	E
	COM	6	7	8	9	10	11	12	13	14							

30° Outside Facing Wedge Seat

451-3730FO	\$1111	\$1175	\$1207	\$1229	\$1273	\$1311	\$1432	\$1513	\$1704	\$2127	\$1357	\$2769	\$3026
COM/yds = 3¼, COL/sq ft = 72													

30° Inside Facing Wedge Seat

451-3730FI	\$1111	\$1175	\$1207	\$1229	\$1273	\$1311	\$1432	\$1513	\$1704	\$2127	\$1357	\$2769	\$3026
COM/yds = 3¼, COL/sq ft = 72													

60° Outside Wedge Loveseat

451-7460FO	\$1767	\$1923	\$1978	\$2027	\$2120	\$2197	\$2426	\$2579	\$2966	\$3701	\$2002	\$4867	\$5379
COM/yds = 6½, COL/sq ft = 143													

60° Inside Wedge Loveseat

451-7460FI	\$1767	\$1923	\$1978	\$2027	\$2120	\$2197	\$2426	\$2579	\$2966	\$3701	\$2002	\$4867	\$5379
COM/yds = 6½, COL/sq ft = 143													

► Specification Information, continued on next page

Circa | Modular Seating

DESIGN ALISON SPEAR, AIA DESIGN ORIGIN: UNITED STATES

► Specification Information, continued from previous page

Specification Information

Style Number	U.S. Base Prices										Leather Grades:		
	Fabric Grades:										COL	C	E
	COM	6	7	8	9	10	11	12	13	14			

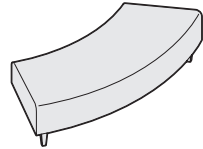

Overall: 33¾"D 71"W 17¼"H
 Inside: 20"D 71"W
 Seat: 17¼"H
 Angle Degree: 60°

60° Outside Wedge Bench

451-B7460FO	\$1422	\$1474	\$1513	\$1529	\$1568	\$1605	\$1715	\$1780	\$1961	\$2447	\$1662	\$2966	\$3206
-------------	--------	--------	--------	--------	--------	--------	--------	--------	--------	--------	--------	--------	--------

COM/yds = 3, COL/sq ft = 66

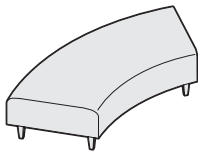

Overall: 33¾"D 71"W 17¼"H
 Inside: 20"D 71"W
 Seat: 17¼"H
 Angle Degree: 60°

60° Inside Wedge Bench

451-B7460FI	\$1422	\$1474	\$1513	\$1529	\$1568	\$1605	\$1715	\$1780	\$1961	\$2447	\$1662	\$2966	\$3206
-------------	--------	--------	--------	--------	--------	--------	--------	--------	--------	--------	--------	--------	--------

COM/yds = 3, COL/sq ft = 66

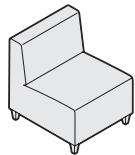

Overall: 28"D 25"W 29½"H
 Inside: 20"D 25"W 12¼"H
 Seat: 17¼"H
 Angle Degree: 0°

Straight Seat Chair

451-2500	\$1013	\$1050	\$1072	\$1087	\$1126	\$1159	\$1246	\$1306	\$1453	\$1814	\$1253	\$2332	\$2529
----------	--------	--------	--------	--------	--------	--------	--------	--------	--------	--------	--------	--------	--------

COM/yds = 2½, COL/sq ft = 55

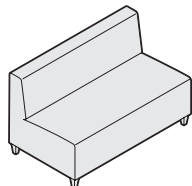

Overall: 28"D 50"W 29½"H
 Inside: 20"D 50"W 12¼"H
 Seat: 17¼"H
 Angle Degree: 0°

Straight Loveseat

451-5000	\$1417	\$1530	\$1573	\$1612	\$1677	\$1743	\$1923	\$2037	\$2338	\$2917	\$1657	\$3850	\$4243
----------	--------	--------	--------	--------	--------	--------	--------	--------	--------	--------	--------	--------	--------

COM/yds = 5, COL/sq ft = 110

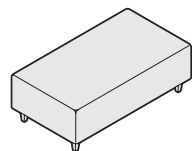

Overall: 28"D 50"W 17¼"H
 Seat: 17¼"D
 Angle Degree: 0°

Straight Bench

451-B5000	\$1291	\$1350	\$1377	\$1393	\$1437	\$1469	\$1578	\$1649	\$1830	\$2284	\$1526	\$2840	\$3069
-----------	--------	--------	--------	--------	--------	--------	--------	--------	--------	--------	--------	--------	--------

COM/yds = 3, COL/sq ft = 66

Ganging Kit

451-GANGPKG	\$ 32	N.A.	N.A.	N.A.	N.A.	N.A.	N.A.	N.A.	N.A.	N.A.	N.A.	N.A.	N.A.
-------------	-------	------	------	------	------	------	------	------	------	------	------	------	------

Tip: Please submit sketch for modular application. One package is required per two chairs.



For Canadian Pricing
 Multiply U.S. Price by the Canadian price factor.
 ► See page 1 for details.

Circa | Upholstered Modular Arm Rests—Straight and 15°

DESIGN ALISON SPEAR, AIA DESIGN ORIGIN: UNITED STATES

Tip: Recommended leathers: are Tulsa Grade C or Dorado Grade E.

Tip: Special color match, consult customer service.

Tip: Pricing based on highest grade textile specified.

Tip: Optional steel leg has 90° corner taper shape.

Tip: These colors are different than other Coalesse powder coats.



Overall: 28"D 18½"W 17"H



Overall: 28"D 18½"W 23½"H
Tip: Specify left or right facing.



Overall: 28¾"D 18½"W 23½"H



Overall: 28¾"D 18½"W 23½"H
Tip: Specify left or right facing.



Overall: 28¾"D 18½"W 17"H



Overall: 28¾"D 18½"W 23½"H
Tip: Specify left or right facing.

Tip: Please submit sketch for modular application. One package is required per two chairs.

Standard Includes	Required to Specify
<ul style="list-style-type: none"> Frame: unibody construction of hardwood plywood utilizing box joinery Upholstery: multiple densities of polyurethane foam Top stitch on seams Legs: hardwood maple or walnut Ganging brackets and hardware included 	<ol style="list-style-type: none"> Style number Fabric or leather color number for arm rests Wood color number for legs Options, if selected (see below) <p>▶ See <i>Surface Materials</i>, page 420.</p>

Options	U.S. Price	Required to Specify
Surface Materials <ul style="list-style-type: none"> Contrasting textiles 	+\$105 per surface	Specify with <i>contrasting textile</i> and specify fabric color number.
Metal Legs <ul style="list-style-type: none"> Powder coat steel legs 	+\$115 per leg	Specify with <i>powder coat steel legs</i> and specify color number: Black Gloss, Gunmetal, Silver Gloss, White Gloss.

Specification Information														
Style Number	U.S. Base Prices												Leather Grades:	
	Fabric Grades:												COL	C
	COM	6	7	8	9	10	11	12	13	14				

Straight Armrest—Intermediate without Legs

451-A1800G	\$617	\$639	\$660	\$676	\$702	\$722	\$795	\$842	\$ 956	\$1148	\$825	\$1669	\$1820
------------	-------	-------	-------	-------	-------	-------	-------	-------	--------	--------	-------	--------	--------

COM/yds = 2¼, COL/sq ft = 50

Straight Armrest—End of Run with Two Legs

451-A1800ER	\$721	\$743	\$764	\$780	\$806	\$826	\$899	\$946	\$1060	\$1273	\$929	\$1773	\$1924
-------------	-------	-------	-------	-------	-------	-------	-------	-------	--------	--------	-------	--------	--------

COM/yds = 2¼, COL/sq ft = 50

15° Inside Armrest—Intermediate without Legs

451-A1815FIG	\$617	\$634	\$650	\$665	\$686	\$707	\$769	\$811	\$ 915	\$1098	\$825	\$1570	\$1705
--------------	-------	-------	-------	-------	-------	-------	-------	-------	--------	--------	-------	--------	--------

COM/yds = 2, COL/sq ft = 44

15° Inside Armrest—End of Run with Two Legs

451-A1815FIER	\$763	\$780	\$796	\$811	\$832	\$853	\$915	\$957	\$1061	\$1273	\$971	\$1716	\$1851
---------------	-------	-------	-------	-------	-------	-------	-------	-------	--------	--------	-------	--------	--------

COM/yds = 2, COL/sq ft = 44

15° Outside Armrest—Intermediate without Legs

451-A1815FOG	\$617	\$634	\$650	\$665	\$686	\$707	\$769	\$811	\$ 915	\$1098	\$825	\$1570	\$1705
--------------	-------	-------	-------	-------	-------	-------	-------	-------	--------	--------	-------	--------	--------

COM/yds = 2, COL/sq ft = 44

15° Outside Armrest—End of Run with Two Legs

451-A1815FOER	\$763	\$780	\$796	\$811	\$832	\$853	\$915	\$957	\$1061	\$1273	\$971	\$1716	\$1851
---------------	-------	-------	-------	-------	-------	-------	-------	-------	--------	--------	-------	--------	--------

COM/yds = 2, COL/sq ft = 44

Ganging Kit

451-GANGPKG	\$ 32	N.A.	N.A.	N.A.	N.A.	N.A.	N.A.	N.A.	N.A.	N.A.	N.A.	N.A.	N.A.
-------------	-------	------	------	------	------	------	------	------	------	------	------	------	------

Coalesse

Circa | Upholstered Modular Arm rests—Straight and 15°

DESIGN ALISON SPEAR, AIA DESIGN ORIGIN: UNITED STATES

Circa | Upholstered Modular Arm rests—30° and Ottoman

DESIGN ALISON SPEAR, AIA DESIGN ORIGIN: UNITED STATES

Tip: Please submit sketch for modular applications. For ganging, contact customer service. 451-GANGPKG is available for \$32 list (one per two chairs).

Tip: These colors are different than other Coalesse powder coats.

Tip: Recommended leathers: are Tulsa Grade C or Dorado Grade E.

Tip: Contrasting option available only on ottoman.

Tip: 90° corner tapered shape leg is standard on arm rests. The ottoman legs are single width taper with no corner.

Tip: Special color match, consult customer service.

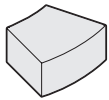

Overall: 29½"D 36¾"W 17"H

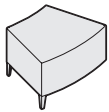

Overall: 29½"D 36¾"W 23½"H
Tip: Specify left or right facing.

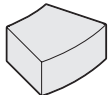

Overall: 29½"D 36¾"W 17"H

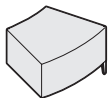

Overall: 29½"D 36¾"W 23½"H
Tip: Specify left or right facing.

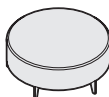

Overall: 42"Dia. 17"H



For Canadian Pricing
Multiply U.S. Price by the Canadian price factor.
► See page 1 for details.

Standard Includes		Required to Specify
	<ul style="list-style-type: none"> • Frame: unibody construction of hardwood plywood utilizing box joinery • Upholstery: multiple densities of polyurethane foam • Top stitch on seams • Legs: hardwood maple or walnut • Ganging brackets and hardware included 	1 Style number 2 Number of fabrics if contrasting fabric style number is selected 3 Fabric or leather color number for arm rests 4 Wood color number for legs 5 Options, if selected (see below) ► See <i>Surface Materials</i> , page 420.

	Options	U.S. Price	Required to Specify
Surface Materials	<ul style="list-style-type: none"> • Contrasting fabric 	+\$105 per fabric	Add suffix K to the style number and select fabric color number.
Metal Legs	<ul style="list-style-type: none"> • Powder coat steel legs 	+\$115 per leg	Specify <i>with powder coat steel legs</i> and specify color number: Black Gloss, Gunmetal, Silver Gloss, White Gloss.

Specification Information													
Style Number	U.S. Base Prices												
	Fabric Grades:												
	COM	6	7	8	9	10	11	12	13	14	Leather Grades: COL C E		

30° Inside Arm Rest—Intermediate without Legs

451-A3730FIG	\$ 862	\$ 905	\$ 931	\$ 947	\$ 983	\$1014	\$1108	\$1170	\$1326	\$1591	\$1070	\$2205	\$2408
--------------	--------	--------	--------	--------	--------	--------	--------	--------	--------	--------	--------	--------	--------

COM/yds = 3, COL/sq ft = 66

30° Inside Arm Rest—End of Run with Two Legs

451-A3730FIER	\$ 976	\$1019	\$1045	\$1061	\$1097	\$1128	\$1222	\$1284	\$1440	\$1728	\$1184	\$2319	\$2522
---------------	--------	--------	--------	--------	--------	--------	--------	--------	--------	--------	--------	--------	--------

COM/yds = 3, COL/sq ft = 66

30° Outside Arm Rest—Intermediate without Legs

451-A3730FOG	\$ 862	\$ 905	\$ 931	\$ 947	\$ 983	\$1014	\$1108	\$1170	\$1326	\$1591	\$1070	\$2205	\$2408
--------------	--------	--------	--------	--------	--------	--------	--------	--------	--------	--------	--------	--------	--------

COM/yds = 3, COL/sq ft = 66

30° Outside Arm Rest—End of Run with Two Legs

451-A3730FOER	\$ 976	\$1019	\$1045	\$1061	\$1097	\$1128	\$1222	\$1284	\$1440	\$1728	\$1184	\$2319	\$2522
---------------	--------	--------	--------	--------	--------	--------	--------	--------	--------	--------	--------	--------	--------

COM/yds = 3, COL/sq ft = 66

Round Ottoman with Five Legs

451-B42RD	\$1397	\$1445	\$1471	\$1492	\$1534	\$1565	\$1669	\$1736	\$1903	\$2284	\$1605	\$2839	\$3057
-----------	--------	--------	--------	--------	--------	--------	--------	--------	--------	--------	--------	--------	--------

COM/yds = ¾, COL/sq ft = 72

Circa | Freestanding Tables

DESIGN ALISON SPEAR, AIA DESIGN ORIGIN: UNITED STATES

Tip: Galvanized aluminum liner is not water tight, plastic liner recommended.

Tip: Please submit sketch for modular applications.

Tip: These colors are different than other Coalesse powder coats.

Tip: Optional steel leg has a 90° corner tapered shape.

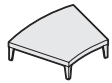

Overall: 29½"D 36⅝"W 8½"H

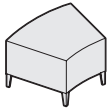

Overall: 29"D 36⅝"W 22½"H

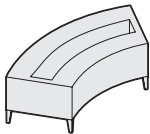

Overall: 33¼"D 70¾"W 22½"H

Standard Includes	Required to Specify
-------------------	---------------------

- Frame: hardwood veneered panels
- Legs: hardwood maple or walnut
- Planter: galvanized aluminum

- 1 Style number
 - 2 Wood color number for legs and frame
 - 3 Options, if selected (see below)
- See *Surface Materials*, page 420.

Options	U.S. Price	Required to Specify
---------	------------	---------------------

Metal Legs	• Powder coat steel legs	+\$115 per leg	Specify with <i>powder coat steel legs</i> and specify color number: Black Gloss, Gunmetal, Silver Gloss, White Gloss.
-------------------	--------------------------	----------------	--

Specification Information

Style Number	U.S. Base Price
--------------	-----------------

30° Freestanding Low Table with Four Legs

45-T3730L	\$1620
-----------	--------

30° Freestanding High Table with Four Legs

45-T3730H	\$2170
-----------	--------

60° Freestanding Table-Planter with Five Legs

45-T7460HP	\$4320
------------	--------



For Canadian Pricing
 Multiply U.S. Price by the Canadian price factor.
 ► See page 1 for details.

Circa | Freestanding Tables

DESIGN ALISON SPEAR, AIA DESIGN ORIGIN: UNITED STATES

Tip: Please submit sketch for modular applications.

Tip: These colors are different than other Coalesse powder coats.

Tip: Optional steel leg has 90° corner taper shape on all tables except 42" round. 42" round has single width taper leg with no corner.

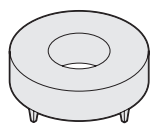

Overall: 42" dia. 15¾"H

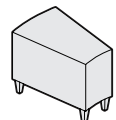

Overall: 28"D 18½"W 22½"H
Angle Degree: 15°

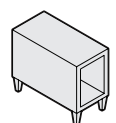

Overall: 27½"D 13½"W 22½"H
Angle Degree: 0°

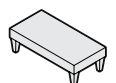

Overall: 27½"D 13½"W 8½"H
Angle Degree: 0°

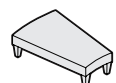

Overall: 28"D 18½"W 8½"H
Angle Degree: 15°



For Canadian Pricing
Multiply U.S. Price by the Canadian price factor.
▶ See page 1 for details.

Standard Includes	Required to Specify
-------------------	---------------------

<ul style="list-style-type: none"> • Frame: hardwood veneered panels • Legs: hardwood maple or walnut 	1 Style number 2 Wood color number for legs and top 3 Options, if selected (see below) ▶ See <i>Surface Materials</i> , page 420.
---	--

Options	U.S. Price	Required to Specify
---------	------------	---------------------

Glass Insert	<ul style="list-style-type: none"> • Glass insert for round table ¾" thick with translucent coating on bottom surface square edge detail 	+\$210	Specify with <i>glass insert</i> .
Metal Legs	<ul style="list-style-type: none"> • Powder coat steel legs 	+\$115 per leg	Specify with <i>powder coat steel legs</i> and specify color number: Black Gloss, Gunmetal, Silver Gloss, White Gloss.
Power/Data Module	<ul style="list-style-type: none"> • Two power/two data ports for round table matte black or silver mica 	+\$310	Specify finish color number.

Specification Information		
---------------------------	--	--

Style Number	U.S. Base Prices	
	Walnut or Maple	Sunburst Top

Freestanding Round Table

45-T42RD	\$2930	\$3156
----------	--------	--------

Freestanding High Wedge Table

45-T1815H	\$1754	N.A.
-----------	--------	------

Freestanding High Straight Table

45-T1300H	\$2069	N.A.
-----------	--------	------

Freestanding Low Straight Table

45-T1300L	\$1355	N.A.
-----------	--------	------

Freestanding Low Wedge Table

45-T1815L	\$1355	N.A.
-----------	--------	------

Circa | Ganging Tables

DESIGN ALISON SPEAR, AIA DESIGN ORIGIN: UNITED STATES

Tip: Optional steel leg is a 90° corner taper leg.

Tip: These colors are different than other Coalesse powder coats.

Tip: Please submit sketch for modular applications. For ganging, contact customer service.

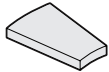

Overall: 28"D 18½"W 8½"H
Angle Degree: 15°

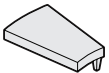

Overall: 28"D 18½"W 8½"H
Angle Degree: 15°

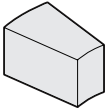

Overall: 28"D 18½"W 22½"H
Angle Degree: 15°

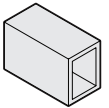

Overall: 27½"D 13½"W 22½"H
Angle Degree: 0°

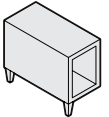

Overall: 27½"D 13½"W 22½"H
Angle Degree: 0°



For Canadian Pricing
Multiply U.S. Price by the Canadian price factor.
► See page 1 for details.

Standard Includes	Required to Specify
<ul style="list-style-type: none"> • Frame: hardwood veneered panels • Legs: hardwood maple or walnut • Ganging brackets and hardware included 	1 Style number 2 Wood color number for legs and top 3 Options, if selected (see below) ► See <i>Surface Materials</i> , page 420.

Options	U.S. Price	Required to Specify
Metal Legs	<ul style="list-style-type: none"> • Powder coat steel legs on end-of-run tables only +\$115 per leg	Specify with <i>powder coat steel legs</i> and specify color number: Black Gloss, Gunmetal, Silver Gloss, White Gloss.
Leg Position	<ul style="list-style-type: none"> • Left-side facing • Right-side facing No cost No cost	Specify with <i>left-side legs</i> . Specify with <i>right-side legs</i> .

Specification Information

Style Number	U.S. Base Price
	Walnut or Maple

Ganging Low Wedge Table	
45-T1815LG	\$1066

End-of-Run Low Wedge Table	
45-T1815LER	\$1208

Ganging High Wedge Table	
45-T1815HG	\$1470

Ganging High Straight Table	
45-T1300HG	\$1780

End-of-Run High Straight Table	
45-T1300HER	\$1953

Lounge Seating

Circa | Ganging Tables *continued*

DESIGN ALISON SPEAR, AIA DESIGN ORIGIN: UNITED STATES

Standard Includes	Required to Specify
-------------------	---------------------

- Frame: hardwood veneered panels
- Top and legs: hardwood maple or walnut
- Ganging brackets and hardware included

- 1 Style number
- 2 Wood color number for top and legs
- 3 Options, if selected (see below)
- ▶ See *Surface Materials*, page 420.

Options	U.S. Price	Required to Specify
---------	------------	---------------------

Metal Legs	<ul style="list-style-type: none"> • Powder coat steel legs on end-of-run tables only 	+\$115 per leg Specify with <i>powder coat steel legs</i> and specify color number: Black Gloss, Gunmetal, Silver Gloss, White Gloss.
Leg Position	<ul style="list-style-type: none"> • Left-side facing • Right-side facing 	No cost No cost Specify with <i>left-side legs</i> . Specify with <i>right-side legs</i> .

Specification Information	
---------------------------	--

Style Number	U.S. Base Price
--------------	-----------------

Tip: Optional steel leg is a 90° corner taper leg.

Tip: Please submit sketch for modular applications. For ganging, contact customer service.

Tip: These colors are different than other Coalesse powder coats.

End-of-Run High Wedge Table

45-T1815HER \$1607

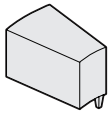

Overall: 28"D 18½"W 22½"H
Angle Degree: 15°

Ganging Low Straight Table

45-T1300LG \$1040

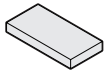

Overall: 27½"D 13½"W 8½"H
Angle Degree: 0°

End-of-Run Low Straight Table

45-T1300LER \$1208

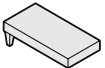

Overall: 27½"D 13½"W 8½"H
Angle Degree: 0°

Options for Creating 90° Applications:

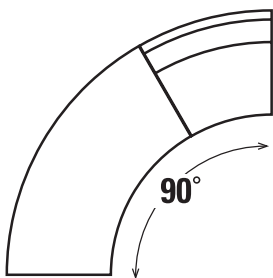

- (1) 30° Outside or Inside Facing Wedge Seat
- (1) 60° Wedge Bench

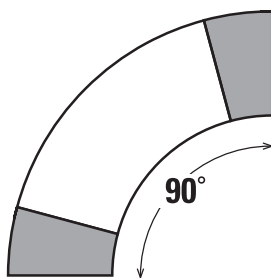

- (2) 15° Wedge Tables
- (1) 60° Wedge Bench

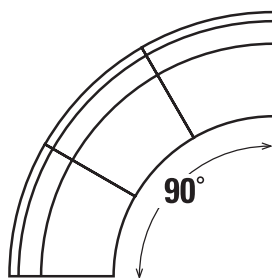

- (3) 30° Outside or Inside Facing Wedge Seats

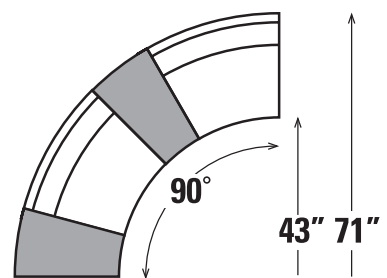

- (2) 30° Outside or Inside Facing Wedge Seats
- (2) 15° Wedge Tables



For Canadian Pricing
 Multiply U.S. Price by the Canadian price factor.
 ▶ See page 1 for details.

Circa | Ganging Tables

DESIGN ALISON SPEAR, AIA DESIGN ORIGIN: UNITED STATES

Tip: Optional steel leg is a 90° corner taper leg.

Tip: These colors are different than other Coalesse powder coats.

Tip: Please submit sketch for modular applications. For ganging, contact customer service.

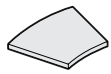

Overall: 29"D 36⁵/₈"W 2"H
(8¹/₂" from floor once assembled)

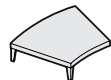

Overall: 29"D 36⁵/₈"W 8¹/₂"H



Overall: 13³/₄"D 27¹/₂"W 22¹/₄"H
(8¹/₂" from floor once assembled)
Tip: Model 45-T28HER has only a single width tapered leg, no corner.

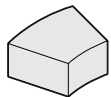

Overall: 29"D 36⁵/₈"W 16"H

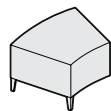

Overall: 29"D 36⁵/₈"W 22¹/₂"H



For Canadian Pricing
Multiply U.S. Price by the Canadian price factor.
► See page 1 for details.

Standard Includes	Required to Specify
<ul style="list-style-type: none"> • Frame: hardwood veneered panels • Top and legs: hardwood maple or walnut • Ganging brackets and hardware included 	1 Style number 2 Wood color number for top and legs 3 Options, if selected (see below) ► See <i>Surface Materials</i> , page 420.

Options	U.S. Price	Required to Specify
Metal Legs <ul style="list-style-type: none"> • Powder coat steel legs on end-of-run tables only 	+ \$115 per leg	Specify with <i>powder coat steel legs</i> and specify color number: Black Gloss, Gunmetal, Silver Gloss, White Gloss.
Leg Position (Available on tables with legs) <ul style="list-style-type: none"> • Left-side facing • Right-side facing 	No cost No cost	Specify with <i>left-side legs</i> . Specify with <i>right-side legs</i> .

Specification Information

Style Number	U.S. Base Price
	Walnut or Maple

30° Ganging without Legs

45-T3730LG	\$1305
------------	--------

30° End-of-Run with Two Legs

45-T3730LER	\$1460
-------------	--------

30° End-of-Run with One Leg

45-T28HER	\$1575
-----------	--------

30° Ganged High Table without Legs

45-T3730HG	\$1860
------------	--------

30° End-of-Run High Table with Two Legs

45-T3730HER	\$2010
-------------	--------

Circa | Ganging Tables *continued*

DESIGN ALISON SPEAR, AIA DESIGN ORIGIN: UNITED STATES

Standard Includes	Required to Specify
<ul style="list-style-type: none"> • Frame: hardwood veneered panels • Top and legs: hardwood maple or walnut • Ganging brackets and hardware included 	1 Style number 2 Wood color number for top and legs 3 Options, if selected (see below) ▶ See <i>Surface Materials</i> , page 420.

Tip: Optional steel leg note: 90° corner taper leg.

Tip: These colors are different than other Coalesse powder coats.

Tip: Please submit sketch for modular applications. For ganging, contact customer service.

Options	U.S. Price	Required to Specify
Metal Legs <ul style="list-style-type: none"> • Powder coat steel legs on end-of-run tables only 	+\$115 per leg	Specify with <i>powder coat steel legs</i> and specify color number: Black gloss, Gunmetal, Silver gloss, White gloss.
Leg Position <ul style="list-style-type: none"> • Left-side facing • Right-side facing 	No cost No cost	Specify with <i>left-side legs</i> . Specify with <i>right-side legs</i> .

Specification Information	
Style Number	U.S. Base Price

60° Ganged Table–Planter with Two Legs Front and Back

45-T7460HPG \$4130

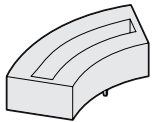

Overall: 33¼"D 70¾"W 22½"H

60° End-of-Run Table–Planter with Three Legs

45-T7460HPER \$4170

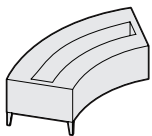

Overall: 33¼"D 70¾"W 22½"H



For Canadian Pricing
 Multiply U.S. Price by the Canadian price factor.
 ▶ See page 1 for details.

Circa | Multi-Fabric Diagram

Applies to all Circa models including: Straight Seat, Wedge, and Straight Loveseat

TO: _____

FROM: _____

DATE: _____

FAX....888.413.5161

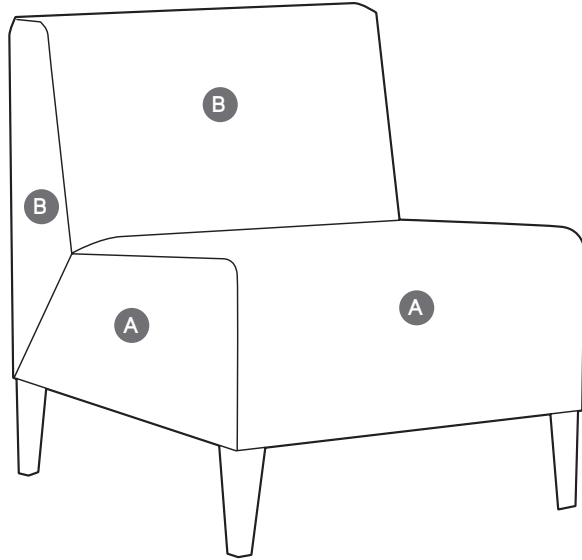

A Upholstery Selection (default for entire unit if B is not selected):

B Back: _____

***\$105 list per contrasting fabric specified. List price based on highest fabric grade usage.**

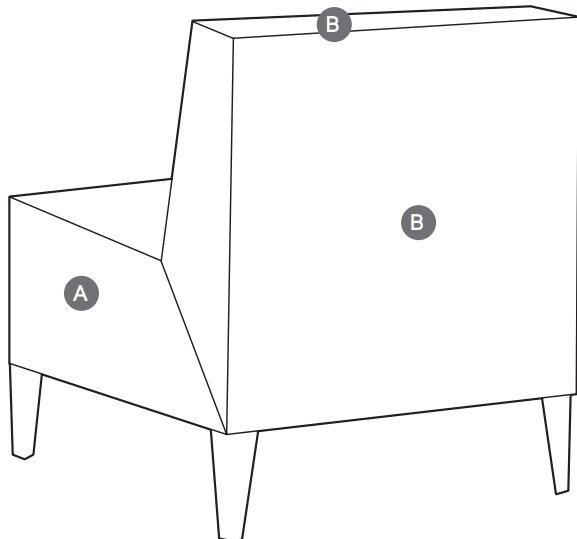

 **For Canadian Pricing**
 Multiply U.S. Price by the
 Canadian price factor.
 ▶ See page 1 for details.