

---

# Coalesse Seating and Occasional Tables

## Volume 5a

► For more detailed product information, see the *Coalesse Specification Guides* or consult your Steelcase dealer.

---

<b>Terms and Conditions</b>	<b>2</b>
<b>Discount Matrix</b>	<b>6</b>
<b>Sample Order Form</b>	<b>12</b>
<b>Steelcase Showrooms and Manufacturing Locations</b>	<b>14</b>

---

<b>Seating/Occasional Tables</b>	<b>15</b>
Lounge Seating	33
Guest/Side/Stack Seating	139
Collaboration Seating	169
Occasional Tables	177
Outdoor	187

---

<b>Surface Materials</b>	<b>195</b>
<b>Resources</b>	<b>235</b>

► For a list of all trademarks, refer to the last page of this specification guide.

---

# Terms and Conditions

Customer Information

SAM Steelcase Unique #GGKLCCKVZ16

**For more information, please contact your participating Steelcase GSA dealer.**

**For more information, please contact your participating Steelcase GSA dealer.**

**For more information, please contact your participating Steelcase GSA dealer.**

**For more information, please contact your participating Steelcase GSA dealer.**

# Discount Matrix

SIN	Product Name		List Tier Minimum	List Tier Maximum	Contract Discount off List (with IFF)
33721	462 Leap	1st Tier	\$1	\$769,468	67.27%
33721	466 Reply	1st Tier	\$1	\$647,668	61.11%
33721	472 Max-Stacker	1st Tier	\$1	\$833,333	69.78%
33721	473 Max Stack II	1st Tier	\$1	\$833,333	69.78%
33721	475 Player	1st Tier	\$1	\$833,333	69.78%
33721	487 Cachet Seating	1st Tier	\$1	\$625,000	59.70%
33721	490 Move	1st Tier	\$1	\$617,284	59.20%
33721	Adj Tables - Airtouch	1st Tier	\$1	\$336,927	70.10%
33721	Adj Tables - Airtouch	2nd Tier	\$336,928	\$649,123	71.29%
33721	Adj Tables - Airtouch	3rd Tier	\$649,124	\$943,396	73.30%
33721	Amia	1st Tier	\$1	\$651,890	61.36%
33721	Answer	1st Tier	\$1	\$727,273	72.29%
33721	Answer	2nd Tier	\$727,274	\$949,848	73.48%
33721	Answer Beam	1st Tier	\$1	\$727,273	72.29%
33721	Answer Beam	2nd Tier	\$727,274	\$949,848	73.48%
33721	Answer Fence	1st Tier	\$1	\$727,273	72.29%
33721	Answer Fence	2nd Tier	\$727,274	\$949,848	73.48%
33721	Answer Freestd Desking	1st Tier	\$1	\$727,273	72.29%
33721	Answer Freestd Desking	2nd Tier	\$727,274	\$949,848	73.48%
33721	Aspekt Series	1st Tier	\$1	\$556,793	54.76%
33721	Avenir	1st Tier	\$1	\$327,869	69.27%
33721	Avenir	2nd Tier	\$327,870	\$672,727	72.29%
33721	Avenir	3rd Tier	\$672,728	\$980,392	74.31%
33721	Await Occasional Tables	1st Tier	\$1	\$578,704	56.48%
33721	B Free - Furniture	1st Tier	\$1	\$555,556	54.66%
33721	B Free - Seating	1st Tier	\$1	\$555,556	54.66%
33721	Ballet Tables	1st Tier	\$1	\$555,552	54.66%
33721	Bassline	1st Tier	\$1	\$621,581	59.48%
33721	Bindu	1st Tier	\$1	\$555,552	54.66%
33721	Bivi	1st Tier	\$1	\$621,581	59.48%
33721	Bix Seating/Tables	1st Tier	\$1	\$555,552	54.66%
33721	Bob Seating/Tables	1st Tier	\$1	\$555,552	54.66%
33721	Bottomline Task Light	1st Tier	\$1	\$632,911	60.20%
33721	Brody Lounge Seating	1st Tier	\$1	\$526,316	52.14%
33721	Buoy	1st Tier	\$1	\$621,581	59.48%
33721	c:scape	1st Tier	\$1	\$229,885	56.17%
33721	c:scape	2nd Tier	\$229,886	\$602,410	58.19%
33721	Campfire	1st Tier	\$1	\$621,581	59.48%
33721	Capa Seating	1st Tier	\$1	\$555,552	54.66%
33721	CF Max	1st Tier	\$1	\$632,911	60.20%
33721	CF Plus	1st Tier	\$1	\$632,911	60.20%
33721	CF Plus HD	1st Tier	\$1	\$632,911	60.20%
33721	CG_1	1st Tier	\$1	\$555,552	54.66%
33721	Chord Seating	1st Tier	\$1	\$555,552	54.66%
33721	Circa Lounge/Tables	1st Tier	\$1	\$555,552	54.66%

SIN	Product Name		List Tier Minimum	List Tier Maximum	Contract Discount off List (with IFF)
33721	Clipper	1st Tier	\$1	\$621,581	59.48%
33721	cobi	1st Tier	\$1	\$623,441	59.60%
33721	Collaboration Seat.	1st Tier	\$1	\$632,911	60.20%
33721	Computer Flat Panel Arms	1st Tier	\$1	\$632,911	60.20%
33721	Computer Support Tools-Des	1st Tier	\$1	\$632,911	60.20%
33721	Convene Conf Collection	1st Tier	\$1	\$684,932	63.23%
33721	Convey	1st Tier	\$1	\$580,046	56.58%
33721	Coupe Seating	1st Tier	\$1	\$555,552	54.66%
33721	Cura Seating	1st Tier	\$1	\$554,324	54.56%
33721	Currency	1st Tier	\$1	\$623,441	59.60%
33721	Davos Seating	1st Tier	\$1	\$555,552	54.66%
33721	Diekman Trees & Softleaf O	1st Tier	\$1	\$555,552	54.66%
33721	Divisio Screens	1st Tier	\$1	\$229,885	56.17%
33721	Divisio Screens	2nd Tier	\$229,886	\$602,410	58.19%
33721	Duo Storage for Answer	1st Tier	\$1	\$727,273	72.29%
33721	Duo Storage for Answer	2nd Tier	\$727,274	\$949,848	73.48%
33721	Elective Elements	1st Tier	\$1	\$265,203	62.72%
33721	Elective Elements	2nd Tier	\$265,204	\$714,286	64.74%
33721	Elective Elements - Param.	1st Tier	\$1	\$265,203	62.72%
33721	Elective Elements - Param.	2nd Tier	\$265,204	\$714,286	64.74%
33721	Embold	1st Tier	\$1	\$512,295	50.83%
33721	Empath Recliner Seating	1st Tier	\$1	\$556,793	54.76%
33721	Emu Seating	1st Tier	\$1	\$533,046	52.75%
33721	Enea Lottus Seating	1st Tier	\$1	\$555,552	54.66%
33721	Enea Lottus Tables	1st Tier	\$1	\$555,552	54.66%
33721	Enea Side Seating	1st Tier	\$1	\$555,552	54.66%
33721	Enea Stools	1st Tier	\$1	\$555,552	54.66%
33721	E-Tables	1st Tier	\$1	\$555,552	54.66%
33721	Everwall	1st Tier	\$1	\$617,284	59.20%
33721	Flex	1st Tier	\$1	\$638,570	60.56%
33721	Flex Active Frames	1st Tier	\$1	\$638,570	60.56%
33721	Flex Had	1st Tier	\$1	\$638,570	60.56%
339113H	Folio	1st Tier	\$1	\$512,295	50.83%
33721	FrameOne	1st Tier	\$1	\$625,000	59.70%
33721	Gesture	1st Tier	\$1	\$655,308	61.56%
33721	Groupwork	1st Tier	\$1	\$641,026	60.71%
33721	High Density Storage	1st Tier	\$1	\$308,333	69.78%
33721	High Density Storage	2nd Tier	\$308,334	\$656,028	71.59%
33721	High Density Storage	3rd Tier	\$656,029	\$972,763	74.11%
33721	Host Casegoods	1st Tier	\$1	\$555,552	54.66%
33721	Hosu Lounge Seating	1st Tier	\$1	\$555,552	54.66%
33721	i2i	1st Tier	\$1	\$573,394	56.07%
33721	Jenny	1st Tier	\$1	\$621,581	59.48%
33721	Joel Lounge Seating	1st Tier	\$1	\$555,552	54.66%
33721	Karman	1st Tier	\$1	\$607,533	58.54%

Discount Matrix, continued

SIN	Product Name		List Tier Minimum	List Tier Maximum	Contract Discount off List (with IFF)
33721	Kart Seating	1st Tier	\$1	\$555,556	54.66%
33721	Kathryn Seating	1st Tier	\$1	\$555,552	54.66%
33721	Kick	1st Tier	\$1	\$330,033	69.47%
33721	Kick	2nd Tier	\$330,034	\$629,252	70.38%
33721	Kick	3rd Tier	\$629,253	\$925,926	72.80%
33721	Lagunitas	1st Tier	\$1	\$555,552	54.66%
33721	LED Desktop	1st Tier	\$1	\$632,911	60.20%
33721	LED Linear	1st Tier	\$1	\$632,911	60.20%
33721	LED Shelf Light	1st Tier	\$1	\$632,911	60.20%
33721	Leela	1st Tier	\$1	\$512,295	50.83%
33721	Lighting - Dash	1st Tier	\$1	\$632,911	60.20%
33721	Lox Seating	1st Tier	\$1	\$555,552	54.66%
33721	Mackinac	1st Tier	\$1	\$641,026	60.71%
33721	Max Stackers III	1st Tier	\$1	\$684,932	63.23%
33721	media:scape	1st Tier	\$1	\$510,204	50.63%
33721	Migration SE Desk	1st Tier	\$1	\$721,501	65.09%
33721	Millbrae	1st Tier	\$1	\$555,552	54.66%
33721	Mineral Recliner Seating	1st Tier	\$1	\$556,793	54.76%
33721	Mitra Recliner & Sleeper	1st Tier	\$1	\$556,793	54.76%
33721	Mitra Series	1st Tier	\$1	\$556,793	54.76%
339113H	Mobile Overbed Tables	1st Tier	\$1	\$512,295	50.83%
33721	Montage	1st Tier	\$1	\$329,489	69.42%
33721	Montage	2nd Tier	\$329,490	\$654,867	71.54%
33721	Montage	3rd Tier	\$654,868	\$952,381	73.55%
33721	Montara650	1st Tier	\$1	\$555,552	54.66%
33721	New Exponents	1st Tier	\$1	\$555,552	54.66%
33721	Node	1st Tier	\$1	\$668,449	62.32%
33721	Ocular	1st Tier	\$1	\$495,050	49.12%
33721	Ology Bench	1st Tier	\$1	\$655,308	61.56%
33721	Ology Desk	1st Tier	\$1	\$655,308	61.56%
33721	Orangebox Air3 Pods	1st Tier	\$1	\$510,204	50.63%
33721	Orangebox Aspect-Cwtch	1st Tier	\$1	\$505,051	50.13%
33721	Orangebox Cubb Seating	1st Tier	\$1	\$505,051	50.13%
33721	Orangebox Cubb Tables	1st Tier	\$1	\$505,051	50.13%
33721	Orangebox On the QT	1st Tier	\$1	\$505,051	50.13%
33721	Organization Worktools	1st Tier	\$1	\$632,911	60.20%
33721	Outlook Sequoia	1st Tier	\$1	\$556,793	54.76%
339113H	Park	1st Tier	\$1	\$512,295	50.83%
33721	Passerelle Lounge/Tables	1st Tier	\$1	\$555,552	54.66%
33721	Pathways Power & Commun.	1st Tier	\$1	\$327,869	69.27%
33721	Pathways Power & Commun.	2nd Tier	\$327,870	\$672,727	72.29%
33721	Pathways Power & Commun.	3rd Tier	\$672,728	\$980,392	74.31%
339113H	Pocket	1st Tier	\$1	\$512,295	50.83%
33721	Power&Cable Mgmt-Worktools	1st Tier	\$1	\$632,911	60.20%



SIN	Product Name	List Tier	List Tier Minimum	List Tier Maximum	Contract Discount off List (with IFF)
33721	Powerstrip Intro	1st Tier	\$1	\$632,911	60.20%
33721	Privacy	1st Tier	\$1	\$632,911	60.20%
33721	Privacy Walls	1st Tier	\$1	\$632,911	60.20%
33721	QiVi	1st Tier	\$1	\$595,238	57.69%
33721	Radia	1st Tier	\$1	\$512,295	50.83%
33721	Regard	1st Tier	\$1	\$512,295	50.83%
339113H	Relay Arm	1st Tier	\$1	\$512,295	50.83%
33721	Ripple Seating	1st Tier	\$1	\$555,552	54.66%
33721	Sarto Privacy Screens	1st Tier	\$1	\$595,238	57.69%
33721	Scoop Stool	1st Tier	\$1	\$621,581	59.48%
33721	Sebastopol	1st Tier	\$1	\$555,552	54.66%
33721	Senza	1st Tier	\$1	\$512,295	50.83%
33721	Series 9000	1st Tier	\$1	\$327,869	69.27%
33721	Series 9000	2nd Tier	\$327,870	\$672,727	72.29%
33721	Series 9000	3rd Tier	\$672,728	\$980,392	74.31%
33721	Shortcut	1st Tier	\$1	\$621,581	59.48%
33721	Sidewalk Seating/Casegoods	1st Tier	\$1	\$555,552	54.66%
33721	Siento Seating	1st Tier	\$1	\$588,235	57.18%
33721	Sieste Seating	1st Tier	\$1	\$555,494	54.66%
33721	Sieste Sleeper	1st Tier	\$1	\$555,494	54.66%
33721	Sieste Tables	1st Tier	\$1	\$555,552	54.66%
33721	SILQ Seating	1st Tier	\$1	\$579,374	56.53%
33721	Slim Leg Had	1st Tier	\$1	\$721,501	65.09%
33721	Sorrel Series	1st Tier	\$1	\$556,793	54.76%
33721	Standard Lighting	1st Tier	\$1	\$727,273	72.29%
33721	Standard Lighting	2nd Tier	\$727,274	\$949,848	73.48%
33721	Steelcase Series 1	1st Tier	\$1	\$630,517	60.05%
33721	Steelcase Series 2	1st Tier	\$1	\$638,570	60.56%
33721	Stella Keyboard Mechanism	1st Tier	\$1	\$621,118	59.45%
33721	Surround	1st Tier	\$1	\$512,295	50.83%
33721	SW_1 Seating	1st Tier	\$1	\$555,552	54.66%
33721	SW_1 Tables	1st Tier	\$1	\$555,552	54.66%
33721	Swathmore Seating	1st Tier	\$1	\$555,552	54.66%
33721	Switch Lounge/Tables	1st Tier	\$1	\$555,552	54.66%
33721	Switch Side/Stool	1st Tier	\$1	\$555,552	54.66%
33721	Tava	1st Tier	\$1	\$512,295	50.83%
33721	Tenor	1st Tier	\$1	\$672,948	62.57%
33721	Think - Task	1st Tier	\$1	\$694,444	63.73%
33721	Thread Floor Power System	1st Tier	\$1	\$531,915	52.65%
33721	Together	1st Tier	\$1	\$555,552	54.66%
33721	Train Tables	1st Tier	\$1	\$555,552	54.66%
33721	TS Bins & Shelves	1st Tier	\$1	\$330,033	69.47%
33721	TS Bins & Shelves	2nd Tier	\$330,034	\$629,252	70.38%

Discount Matrix, continued

SIN	Product Name		List Tier Minimum	List Tier Maximum	Contract Discount off List (with IFF)
33721	TS Bins & Shelves	3rd Tier	\$629,253	\$925,926	72.80%
33721	TS Fixed Pedestals	1st Tier	\$1	\$757,576	66.75%
33721	TS Laterals	1st Tier	\$1	\$757,576	66.75%
33721	TS Lockers	1st Tier	\$1	\$757,576	66.75%
33721	TS Mobile Pedestals	1st Tier	\$1	\$757,576	66.75%
33721	TS Tower Too	1st Tier	\$1	\$757,576	66.75%
33721	TS Underworksurface Latera	1st Tier	\$1	\$757,576	66.75%
33721	TS Worksurfaces	1st Tier	\$1	\$330,033	69.47%
33721	TS Worksurfaces	2nd Tier	\$330,034	\$629,252	70.38%
33721	TS Worksurfaces	3rd Tier	\$629,253	\$925,926	72.80%
33721	Umami	1st Tier	\$1	\$531,915	52.65%
33721	Univ Bookcases	1st Tier	\$1	\$300,325	68.97%
33721	Univ Bookcases	2nd Tier	\$300,326	\$637,931	70.78%
33721	Univ Bookcases	3rd Tier	\$637,932	\$943,396	73.30%
33721	Univ Combination Cabinets	1st Tier	\$1	\$300,325	68.97%
33721	Univ Combination Cabinets	2nd Tier	\$300,326	\$637,931	70.78%
33721	Univ Combination Cabinets	3rd Tier	\$637,932	\$943,396	73.30%
33721	Univ Hard Surface Screen	1st Tier	\$1	\$595,238	57.69%
33721	Univ ITC/OTC Bins/Shelves	1st Tier	\$1	\$727,273	72.29%
33721	Univ ITC/OTC Bins/Shelves	2nd Tier	\$727,274	\$949,848	73.48%
33721	Univ Lateral Files	1st Tier	\$1	\$300,325	68.97%
33721	Univ Lateral Files	2nd Tier	\$300,326	\$637,931	70.78%
33721	Univ Lateral Files	3rd Tier	\$637,932	\$943,396	73.30%
33721	Univ Pedestals	1st Tier	\$1	\$727,273	72.29%
33721	Univ Pedestals	2nd Tier	\$727,274	\$949,848	73.48%
33721	Univ Privacy Screens	1st Tier	\$1	\$727,273	72.29%
33721	Univ Privacy Screens	2nd Tier	\$727,274	\$949,848	73.48%
33721	Univ Storage Cabinets	1st Tier	\$1	\$300,325	68.97%
33721	Univ Storage Cabinets	2nd Tier	\$300,326	\$637,931	70.78%
33721	Univ Storage Cabinets	3rd Tier	\$637,932	\$943,396	73.30%
33721	Univ System WKSF-Wood	1st Tier	\$1	\$727,273	72.29%
33721	Univ System WKSF-Wood	2nd Tier	\$727,274	\$949,848	73.48%
33721	Univ Towers	1st Tier	\$1	\$300,325	68.97%
33721	Univ Towers	2nd Tier	\$300,326	\$637,931	70.78%
33721	Univ Towers	3rd Tier	\$637,932	\$943,396	73.30%
33721	Universal Lockers	1st Tier	\$1	\$300,325	68.97%
33721	Universal Lockers	2nd Tier	\$300,326	\$637,931	70.78%
33721	Universal Lockers	3rd Tier	\$637,932	\$943,396	73.30%
33721	Universal Storage Acc.	1st Tier	\$1	\$300,325	68.97%
33721	Universal Storage Acc.	2nd Tier	\$300,326	\$637,931	70.78%
33721	Universal Storage Acc.	3rd Tier	\$637,932	\$943,396	73.30%
33721	Universal System Worksurfa	1st Tier	\$1	\$727,273	72.29%
33721	Universal System Worksurfa	2nd Tier	\$727,274	\$949,848	73.48%

<b>SIN</b>	<b>Product Name</b>		<b>List Tier Minimum</b>	<b>List Tier Maximum</b>	<b>Contract Discount off List (with IFF)</b>
33721	Universal Tables	1st Tier	\$1	\$727,273	72.29%
33721	Universal Tables	2nd Tier	\$727,274	\$949,848	73.48%
33721	Vecta Electrical	1st Tier	\$1	\$555,552	54.66%
33721	Verb	1st Tier	\$1	\$609,756	58.69%
339113H	Verge Stool	1st Tier	\$1	\$517,277	51.31%
33721	Verlay	1st Tier	\$1	\$704,225	64.23%
33721	Victor2	1st Tier	\$1	\$657,895	61.72%
33721	Visalia	1st Tier	\$1	\$555,552	54.66%
33721	Worksurface Side Screens	1st Tier	\$1	\$625,000	59.70%
33721	Workvalet	1st Tier	\$1	\$632,911	60.20%
33721	Wrapp	1st Tier	\$1	\$555,552	54.66%
33721	X-Tenz	1st Tier	\$1	\$554,324	54.56%

# Sample Order Form

## Sample Order Form

ORDER FOR SUPPLIES OR SERVICES	PAGE _____ OF _____ PAGES
--------------------------------	---------------------------

IMPORTANT: Mark all packages and papers with contract and/or order numbers.

DATE OF ORDER <b>1</b> 4-15-24	CONTRACT NO. (If any) <b>2</b> 47QSMS24D0034	ORDER NO. <b>3</b> 10 - 000	REQUISITION/REFERENCE NO.
-----------------------------------	---	--------------------------------	---------------------------

ISSUING OFFICE (Address correspondence to) <b>4</b> GSA 1 Town Street City, State, Zip Name and Telephone Number	SHIP TO: (Consignee and address, ZIP Code) <b>5</b> GSA 2 Town Street City, State, Zip Name and Telephone Number
--	--

TO: CONTRACTOR (Name, address and ZIP Code) <b>6</b> Steelcase Inc. c/o Participating Dealer 901 44th Street, SE Grand Rapids, MI 49508 Attn: Solutions Fullfillment Team CH-2W-SS (GSA)	Cage Code: 39880	TYPE OF ORDER <input type="checkbox"/> A. PURCHASE — Reference your _____  Please furnish the following on the terms and conditions specified on both sides of this order and on the attached sheets, if any, including delivery as indicated. This purchase is negotiated under authority of: _____  <input type="checkbox"/> B. DELIVERY — Except for billing instructions on the reverse, this delivery order is subject to instructions contained on this side only of this form and is issued subject to the terms and conditions of the above-numbered contract.
--	------------------	---

ACCOUNTING AND APPROPRIATION DATA	REQUISITIONING OFFICE
-----------------------------------	-----------------------

BUSINESS CLASSIFICATION (Check appropriate box(es)) <b>20</b> <input type="checkbox"/> SMALL <input checked="" type="checkbox"/> OTHER THAN SMALL <input type="checkbox"/> DIS-ADVANTAGED <input type="checkbox"/> WOMEN-OWNED
--

FCA DESTINATION <b>7</b>	GOVERNMENT NO.	DELIVER TO FCA DESTINATION ON OR BEFORE (Date) <b>8</b> ARO date	DISCOUNT TERMS <b>9</b> Net 30 days
PLACE OF INSPECTION AND ACCEPTANCE			

(See reverse for Rejections)

ITEM NO. (A)	SUPPLIES OR SERVICES (B)	QUANTITY ORDERED (C)	UNIT (D)	UNIT PRICE (E)	AMOUNT (F)	QUANTITY ACCEPTED (G)
1	<b>10</b> One lot of Steelcase Office Furniture: See attached specifications	<b>13</b> 1		<b>14</b> \$000	<b>15</b> \$000	
2	<b>11</b> Design: \$65.49/hour	2 hrs		\$000	\$000	
3	<b>12</b> Installation	1		\$000	\$000	

SEE BILLING INSTRUCTIONS ON REVERSE	SHIPPING POINT	GROSS SHIPPING WEIGHT	INVOICE NO.		(H) TOT. (Cont. pages) ◀
	MAIL INVOICE TO: (Include ZIP Code) <b>17</b> GSA, 3 Town Street, City, State, Zip			<b>16</b> \$000	(i). GRAND TOTAL ◀

UNITED STATES OF AMERICA BY (Signature) ▶ <b>18</b> Contracting Officer signature and telephone no.	NAME (Typed) <b>19</b> John Doe, Department Manager TITLE: CONTRACTING/ORDERING OFFICER
--	---

NSN 7540\_01\_152\_8083

50347-101

OPTIONAL FORM 347 (10-83)  
Prescribed by GSA  
FAR (48 CFR) 53.213 (e)

- 1 Order date
- 2 Contract number
- 3 Order number
- 4 Issuing office: Requester name and telephone number
- 5 Shipping address: Contact name and telephone number
- 6 Contractor:  
**Steelcase Inc.**  
**c/o Participating Dealer**  
**901 - 44th Street, S.E.**  
**Grand Rapids, MI 49508**  
**Attn: Solutions Fulfillment Team**
- 7 FCA destination
- 8 ARO date (After Receipt of Order)
- 9 Terms: Net 30 days
- 10 Complete product description, including SIN number, style number, all applicable surface materials.
- 11 Separate line for design
- 12 Separate line for installation
- 13 Quantity ordered
- 14 Individual unit price
- 15 Amount (quantity x unit price)
- 16 Total cost
- 17 Invoice address
- 18 Authorized contracting officer signature and telephone number
- 19 Authorized contracting officer name and title (typed)
- 20 Steelcase is the seller of record and is not registered as "small," "disadvantaged," or "woman-owned." If one of these boxes is checked in error, a modification will be required.

**Please note on order** that all invoice payments must be sent to:

Steelcase Inc.  
62087 Collection Center Dr.  
Chicago, IL 60693-0620

**Storage and Delays**

(Open Market) In the event that the site is not accessible, or safe and adequate storage space is not available during installation, the furnishings will be stored until delivery or installation can be accomplished. Pricing for storage will be negotiated on a project-by-project basis. Invoices will be sent to the local government purchasing facility upon delivery of the furniture to a designated storage facility. Steelcase shall provide notice to the Government purchasing facility that the furnishings are available for inspection by the Government at the Storage facility. Upon this notice, the Government, or representative for the Government, must inspect and accept the furniture prior to payment of any invoice. The inspection and acceptance must be completed within 15 days. Payment will be made by the Government 30 days after acceptance of the furniture.

# Steelcase Showrooms and Manufacturing Locations

## Showrooms

### Atlanta

Steelcase Inc.  
Suite 280  
1545 Peachtree Street NE  
Atlanta, GA 30309  
Phone: (404) 523-2201

### Chicago

Steelcase Worklife Chicago  
Suite 300  
222 Merchandise Mart  
Chicago, IL 60654-1174  
Phone: (312) 321-3720

### Dallas

Steelcase Inc.  
1616 Hi Line Drive  
Dallas, TX 75207  
Phone: (214) 871-3044

### Grand Rapids

Steelcase Inc.  
901 44th Street, SE  
Grand Rapids, MI 49508-7594  
Phone: (616) 247-2710

### New York

Steelcase Worklife New York  
4 Columbus Circle  
New York, NY 10019-1100  
Phone: (212) 445-8800

### Philadelphia

Steelcase Inc.  
One Liberty Place  
1650 Market Street, 3rd Floor  
Philadelphia, PA 19103-7307  
Phone: (215) 561-5331

### San Francisco

Steelcase Inc.  
Suite 110  
475 Brannan Street  
San Francisco, CA 94107  
Phone: (415) 344-6700

### Washington D.C.

Steelcase Inc.  
1000 F St NW #1000  
Washington, DC 20004

### Los Angeles

1150 S Olive St  
Los Angeles, CA 90015  
Phone: (310) 633-2200

## Manufacturing Sites

### Amex de Mexico

Calle 5 Sur No.160  
Ciudad Industrial  
Tijuana, Mexico B.C. 22500  
Phone: 52-662-342-6234

### Athens

214 Durham Drive  
Athens, AL 35611  
Phone: (256) 232-8112

### Grand Rapids Wood Furniture

4100 68th Street SE  
Caledonia, MI 49316  
Phone: (616) 698-5735

### Kentwood Distribution Center

4384 52nd Street SE  
Kentwood, MI 49512-9673

### Kentwood West

4360 52nd Street SE  
Kentwood, MI 49512

### Worktools

901 44th Street SE  
Grand Rapids, MI 49508  
Phone: (616) 247-2710

### Reynosa Plant

Ave. Prologis S/N Ed. 8 Suite  
801 Prologis Park Pharr Bridge  
Reynosa,  
Tamaulipas, Mx CP. 88780  
Phone: 52-899-263-9000

---

# Seating/Occasional Tables

---

Statement of Line 16

---

Lounge Seating (SIN 33721)	33
Guest/Side/Stack Seating (SIN 33721)	139
Collaboration Seating (SIN 33721)	169
Occasional Tables (SIN 33721)	177
Outdoor (SIN NEW)	187

# Statement of Line

## Lounge Seating

### Await Lounge System

Specifying  
▶ Page 34

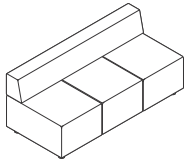

Three-Seat Lounge

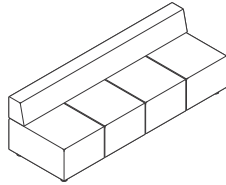

Four-Seat Lounge

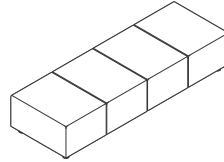

Four-Seat Bench



Mobile Ottoman

### Await Lounge System Connector Benches and Tables

Specifying  
▶ Pages 36 and 37

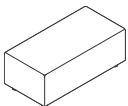

1-Section Connector Bench

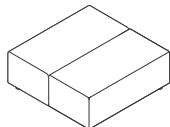

2-Section Connector Bench

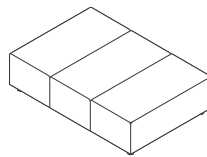

3-Section Connector Bench

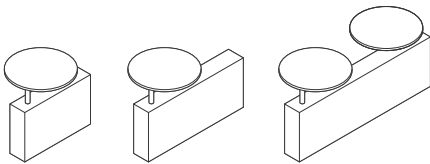

Connector Tables

### Bix Lounge System Lounge Chairs

Specifying  
▶ Page 40

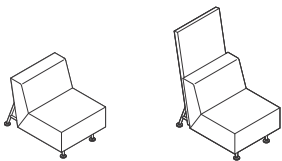

### Bix Lounge System Sled Lounge Chairs

Specifying  
▶ Page 41

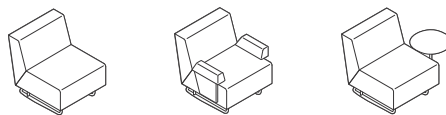



# Statement of Line

## Lounge Seating, continued

### Bix Lounge System Sectional Seating

Specifying  
▶ Page 42

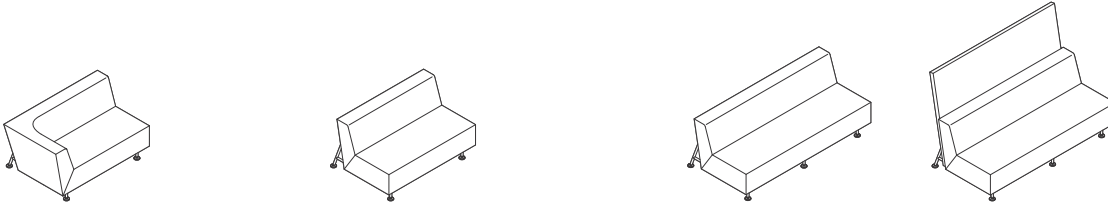

### Bix Lounge System Benches

Specifying  
▶ Page 45

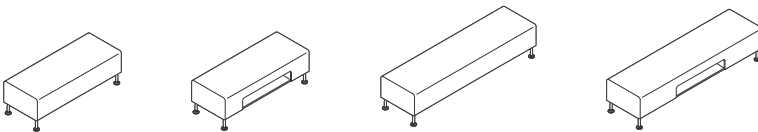

### Bob Lounge Chairs

Specifying  
▶ Page 50

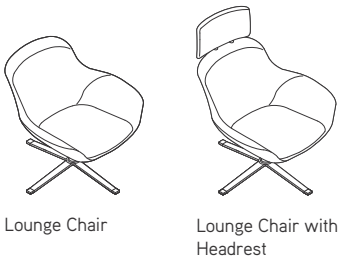

Lounge Chair

Lounge Chair with  
Headrest

# Statement of Line *continued*

## Lounge Seating, continued

### Circa Lounge System

Specifying  
▶ Page 52

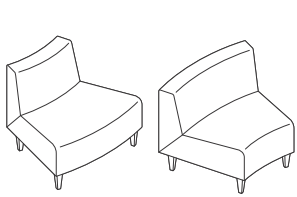

30° Outside/Inside  
Facing Wedge  
1-Seat Lounge

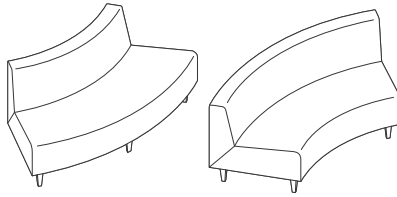

60° Wedge  
2-Seat Lounge

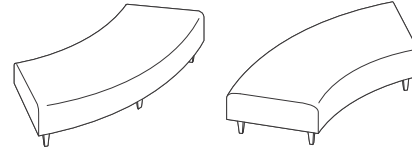

Wedge Bench

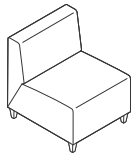

Straight Seat  
1-Seat Lounge

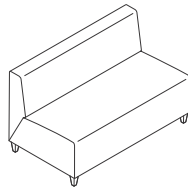

Straight  
2-Seat Lounge

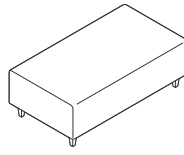

Straight Bench

### Circa Lounge System Upholstered Modular Arm Rests and Ottoman

Specifying  
▶ Page 56



Straight Armrest  
Intermediate without Legs

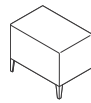

Straight Armrest  
End-of-Run with Two Legs



15° Inside Armrest  
Intermediate without Legs

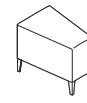

15° Inside Armrest  
End-of-Run with Two Legs



15° Outside Armrest  
Intermediate without Legs



15° Outside Armrest  
End-of-Run with Two Legs

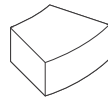

30° Inside Armrest  
Intermediate without Legs

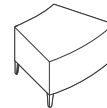

30° Inside Armrest  
End-of-Run with Two Legs

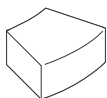

30° Outside Armrest  
Intermediate without Legs

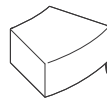

30° Outside Armrest  
End-of-Run with Two Legs

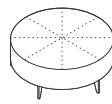

Round Ottoman

# Statement of Line

## Lounge Seating, continued

### Circa Lounge System Modular Tables

Specifying  
▶ Page 58

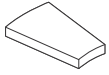

15° Low Wedge Table, Ganging

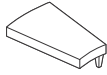

15° Low Wedge Table, End-of-Run, Two Legs

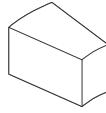

15° High Wedge Table, Ganging

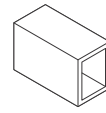

Straight High Table, Ganging

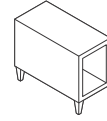

Straight High Table, End-of-Run, Two Legs

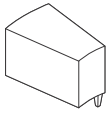

15° High Wedge Table, End-of-Run, Two Legs

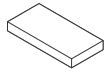

Straight Low Table, Ganging

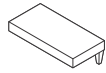

Straight Low Table, End-of-Run, Two Legs

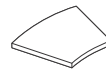

30° Low Wedge Table, Ganging



30° Low Wedge Table, End-of-Run, Two Legs



30° End-of-Run with One Leg

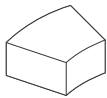

30° High Wedge Table, Ganging

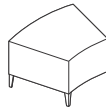

30° High Wedge Table, End-of-Run, Two Legs

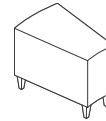

High Wedge

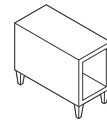

High Straight

### Circa Lounge System Freestanding Round Table

Specifying  
▶ Page 61

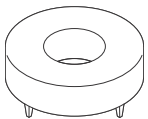

Round

### Coupe Lounge Seating

Specifying  
▶ Page 64

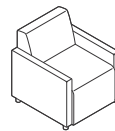

Lounge Chair

### Coupe Grande/Mobile Lounge Seating

Specifying  
▶ Page 65

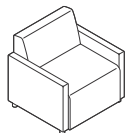

Grande Lounge Chair

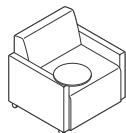

Grande Mobile Lounge Chair

### Joel Lounge Chair

Specifying  
▶ Page 66

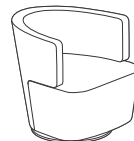

# Statement of Line *continued*

## Lounge Seating, continued

### Ripple Bench

Specifying  
▶ Page 68

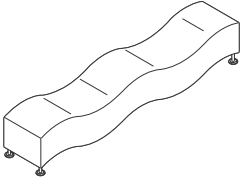

Upholstered  
Wave Seat

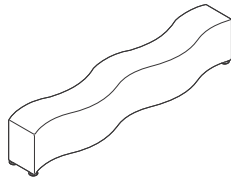

Upholstered  
Flat Seat

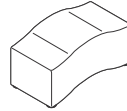

Little Ripple  
Wave Seat

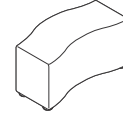

Little Ripple  
Flat Seat

### Sidewalk Lounge Seating

Specifying  
▶ Page 70

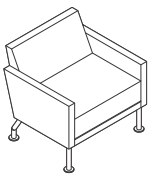

Low-Back Lounge Chair

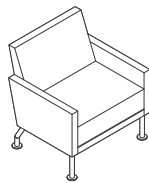

High-Back Lounge Chair

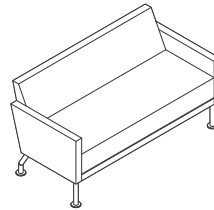

Two-Seat Lounge

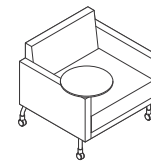

Mobile Low-Back Lounge  
Chair with Tablet

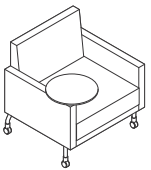

Mobile High-Back Lounge  
Chair with Tablet



Arm Bolster

### Sidewalk Collaborative Lounge Seating

Specifying  
▶ Page 74

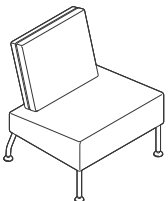

Lounge Chair

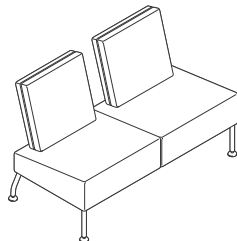

Two-Seat Lounge

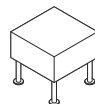

Ottoman

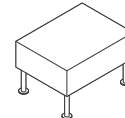
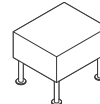

# Statement of Line

## Lounge Seating, continued

### Sidewalk Lounge Seating Benches/Ottoman

Specifying  
▶ Page 76

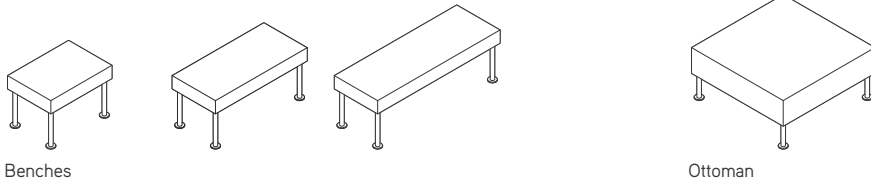

Benches

Ottoman

### Davos Lounge Seating

Specifying  
▶ Page 78

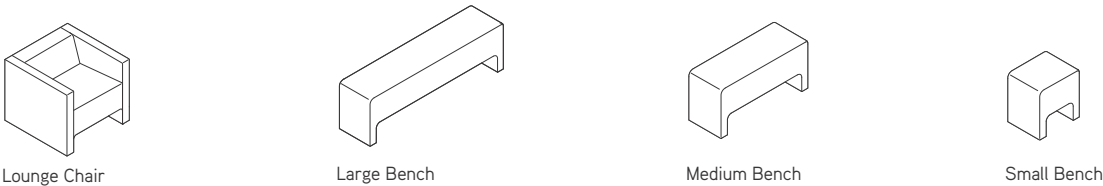

Lounge Chair

Large Bench

Medium Bench

Small Bench

### Hosu Lounge Seating

Specifying  
▶ Page 80



Lounge Chair with Lumbar Pillow

Lounge Chair with Ottoman and Lumbar Pillow

Two-Seat Lounge with Two Lumbar Pillows

### Millbrae Lifestyle Lounge Seating

Specifying  
▶ Page 82

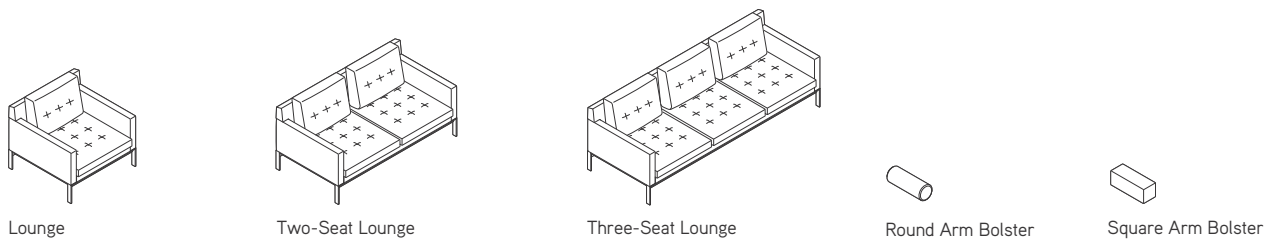

Lounge

Two-Seat Lounge

Three-Seat Lounge

Round Arm Bolster

Square Arm Bolster

## Lounge Seating, continued

### Millbrae Contract Lounge Seating

Specifying  
▶ Page 82

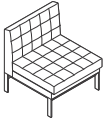

Lounge  
without Arms

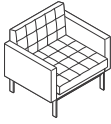

Lounge  
with Arms



Lounge  
with Left Arm Facing

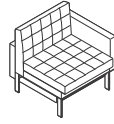

Lounge  
with Right Arm Facing

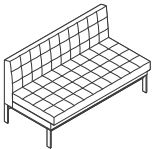

Two-Seat Lounge  
without Arms

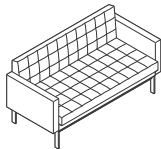

Two-Seat Lounge  
with Arms

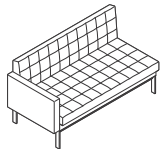

Two-Seat Lounge  
with Left Arm Facing

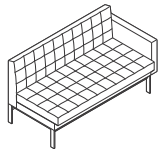

Two-Seat Lounge  
with Right Arm Facing

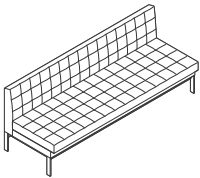

Three-Seat Lounge  
without Arms

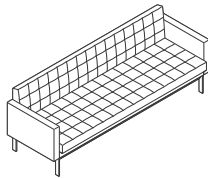

Three-Seat Lounge  
with Arms

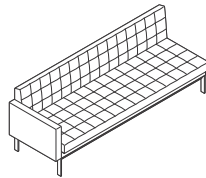

Three-Seat Lounge  
with Left Arm Facing

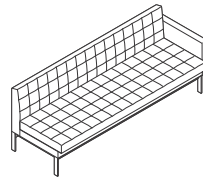

Three-Seat Lounge  
with Right Arm Facing

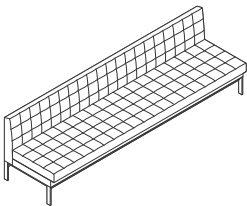

Four-Seat Lounge  
without Arms

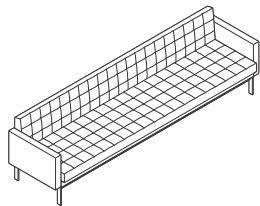

Four-Seat Lounge  
with Arms

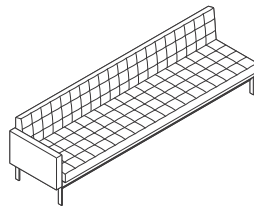

Four-Seat Lounge  
with Left Arm Facing

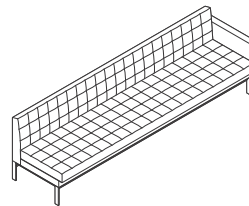

Four-Seat Lounge  
with Right Arm Facing

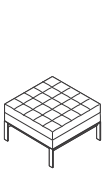

One-Seat  
Bench

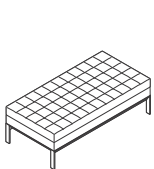

Two-Seat Bench

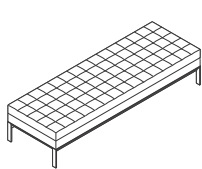

Three-Seat Bench

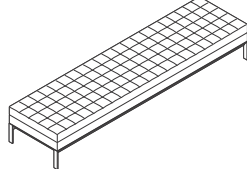

Four-Seat Bench

# Statement of Line

## Lounge Seating, continued

### Lagunitas Lounge System

Specifying  
▶ Pages 88-117

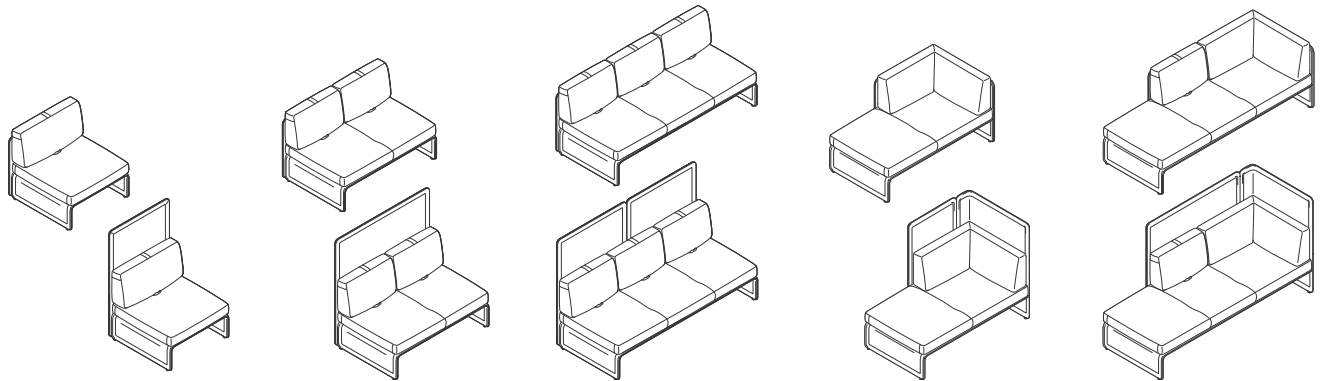

1-Seat Lounges

2-Seat Lounges

3-Seat Lounges

2-Seat Chaises

3-Seat Chaises

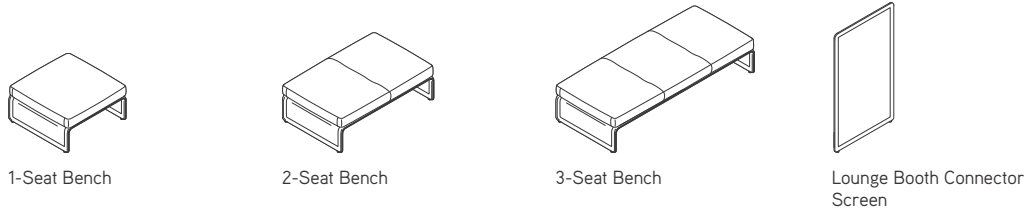

1-Seat Bench

2-Seat Bench

3-Seat Bench

Lounge Booth Connector  
Screen

### Lagunitas Focus Nook

Specifying  
▶ Page 118

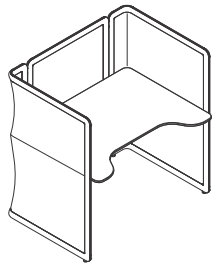

# Statement of Line *continued*

## Lounge Seating, continued

### Passerelle Lounge Seating

Specifying  
▶ Pages 120-122

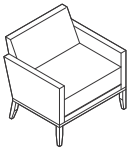

Lounge Chair

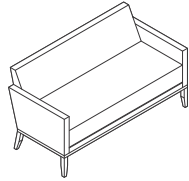

2-Seat Lounge

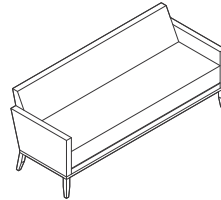

3-Seat Lounge



Arm Bolster

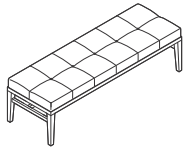
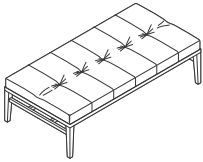

Benches

### Switch Lounge Seating

Specifying  
▶ Page 124



Lounge Chair

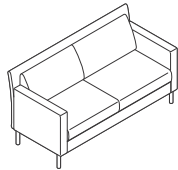

Two-Seat Lounge

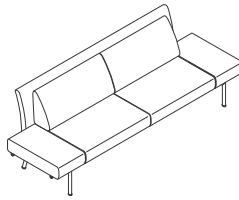

Two-Seat Lounge with  
Extensions

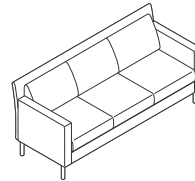

Three-Seat Lounge



Arm Bolster

### SW\_1 Lounge Seating

Specifying  
▶ Page 126



Low-Back Collaborative  
Lounge Chair



High-Back Collaborative  
Lounge Chair



Ottoman



# Statement of Line

## Lounge Seating, continued

### Together Bench

Specifying  
▶ Page 130

70½"D 96¼"W 31"H

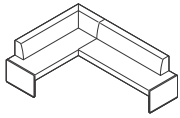

Left Corner with Back 8" Offset

97¼"D 96¼"W 31"H

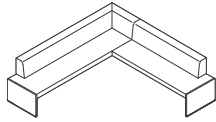

70½"D 96¼"W 31"H

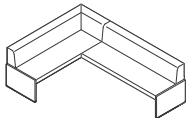

Right Corner with Back 8" Offset

97¼"D 96¼"W 31"H

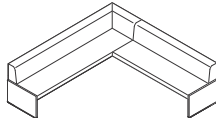

70½"D 96¼"W 31"H

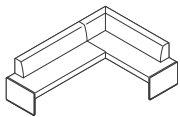

Right Corner with Back 1.5" Offset

97¼"D 96¼"W 31"H

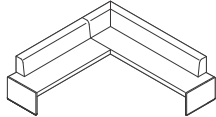

70½"D 123"W 31"H

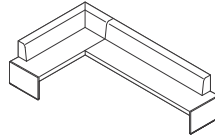

70½"D 123"W 31"H

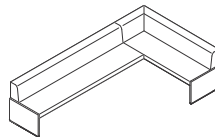

Straight with 1.5" Offset Back

97¼"D 123"W 31"H

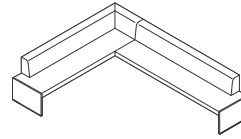

26¾"D 71"W 31"H

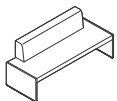

Straight with 8" Offset Back

26¾"D 97¾"W 31"H

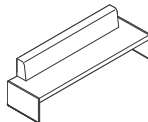

26¾"D 97¾"W 18½"H

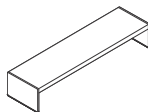

Straight without Back

26¾"D 71"W 31"H

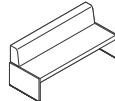

26¾"D 97¾"W 31"H

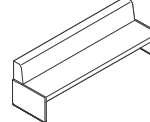

# Statement of Line *continued*

## Lounge Seating, continued

### Visalia Lounge Seating

Specifying  
▶ Page 136

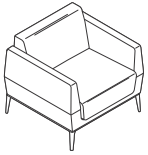

Lounge Chair

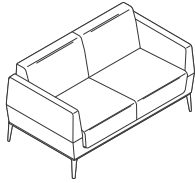

Two-Seat Lounge

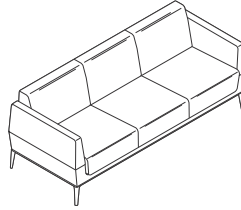

Three-Seat Lounge

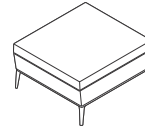

Ottoman

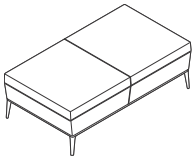

Bench

## Guest/Side/Stack Seating

### Bindu Chairs

Specifying  
▶ Page 140

### Bob Chair

Specifying  
▶ Page 141



Low-Back Chair



Mid-Back Chair



Guest Chair



Ottoman

### Capa Chair

Specifying  
▶ Page 142



# Statement of Line

## Guest/Side/Stack Seating, continued

### Enea Café Wood Stools

Specifying  
▶ Page 144



Café Wood Counter-Height  
Stool Upholstered Seat



Café Wood Bar-Height Stool  
Upholstered Seat



Café Wood Counter-Height  
Stool



Café Wood Bar-Height Stool

### Enea Lottus Seating

Specifying  
▶ Pages 146-152



Armless Chair



Cantilever Arm Chair



Aluminum Loop  
Arm Chair



Counter-Height  
Sled Base Stool



Bar-Height  
Sled Base Stool

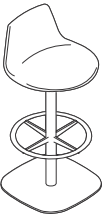

Counter-Height  
Post Base Stool

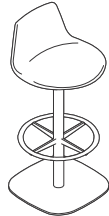

Base-Height  
Post Base Stool

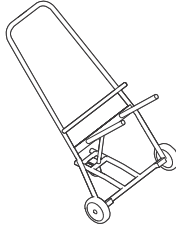

Dolly

### Kathryn Chairs

Specifying  
▶ Page 154

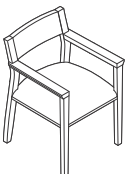

Open Wood Back

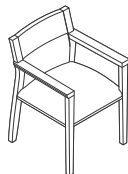

Upholstered Wood  
Back Panel

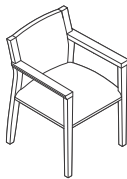

Fully Upholstered  
Back

# Statement of Line *continued*

## Guest/Side/Stack Seating, continued

### Lox Stools

Specifying  
▶ Page 156



Counter-Height Stool



Bar-Height Stool

### Switch Chairs and Stools

Specifying  
▶ Pages 158-159

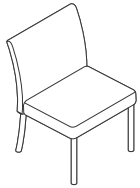

Armless Chair

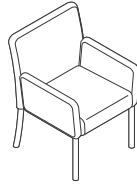

Arm Chair

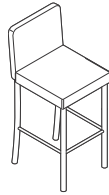

Counter-Height Stool

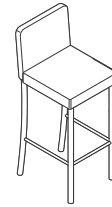

Bar-Height Stool

### Montara650 Chairs and Stools

Specifying  
▶ Pages 160-164



Wood Shell, Wood Shell with Upholstered Seat, Wood Shell with  $\frac{3}{4}$  Upholstery, and Fully Upholstered



Wood Shell with Upholstered Seat, Wood Shell with  $\frac{3}{4}$  Upholstery, and Fully Upholstered



Counter-Height or Bar-Height Stool: Wood Shell, Wood Shell with Upholstered Seat, and Fully Upholstered

### Montara650 Rocker

Specifying  
▶ Page 166



Wood Shell with Upholstered Seat, Wood Shell with  $\frac{3}{4}$  Upholstery, and Fully Upholstered

### Wrapp Chairs

Specifying  
▶ Page 168



Four-Leg Chair



Sled-Base Chair

# Statement of Line

## Collaboration Seating

### Bindu Conference Seating

Specifying  
▶ Page 170



Mid-Back Conference  
Chair



High-Back Conference  
Chair

### Chord Conference Seating

Specifying  
▶ Page 172



Conference Narrow

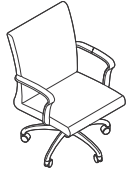

Mid-Back



High-Back Narrow



High-Back/Large Scale

### SW\_1 Conference Seating

Specifying  
▶ Page 174



Conference Chair  
with 4-Star Base



Conference Chair  
with 5-Star Base

# Statement of Line *continued*

## Occasional Tables

### Await Occasional Tables

Specifying  
▶ Page 178

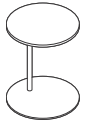

Freestanding  
Low Round



Freestanding  
High Round

### Enea Lottus Tables

Specifying  
▶ Pages 179–183

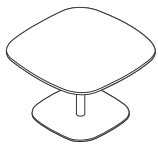

Occasional



Conference



Café Counter Height

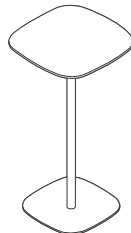

Café Bar Height

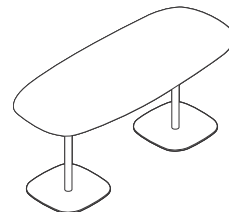

Rectangular

### Sebastopol Occasional Tables

Specifying  
▶ Page 184

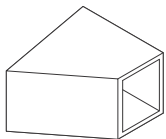

16" High Tables

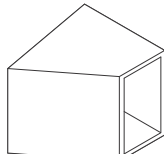
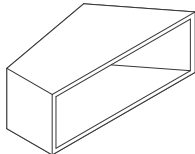

22" High Tables

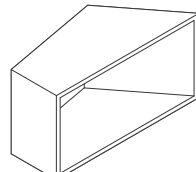

### Trees Occasional Tables

Specifying  
▶ Page 185

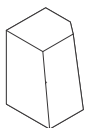

Bevel High-  
Embossed Wood

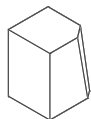

Bevel Medium-  
Embossed Wood

# Statement of Line

## Outdoor

### Emu Heaven

Specifying  
▶ Pages 188-190



Chair

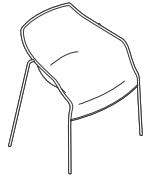

Arm Chair

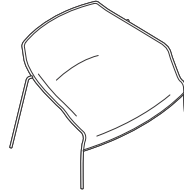

Lounge Chair



Pouf/Side Table



Low Vase



High Vase

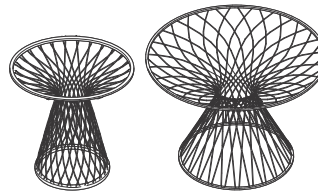

Round Table Bases

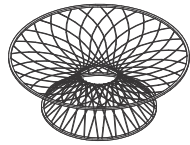

Low Table Base

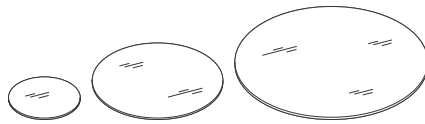

Glass Tops

### Emu Round

Specifying  
▶ Pages 192-194

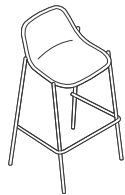

Stool



Chair



Arm Chair

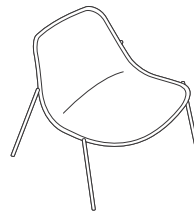

Lounge

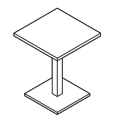

Square Tables

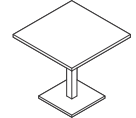
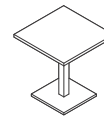

Round Table

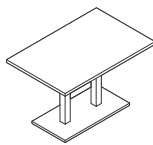

Rectangle Table

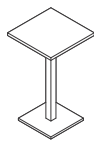

Counter Table

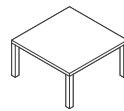

Side Table

Tip: Cushions are available for indoor and outdoor use.





# Lounge Seating

Await	34
Bix	40
Bob Chairs	50
Circa	52
Coupe	64
Coupe Grande/Mobile	65
Joel Lounge	66
Ripple	68
Sidewalk	70
Davos	78
Hosu	80
Millbrae	82
Lagunitas	88
Lagunitas Focus Nook	118
Passerelle	120
Switch	124
SW_1	126
Together Bench	130
Visalia	136

# Await Lounge System

DESIGN E00S

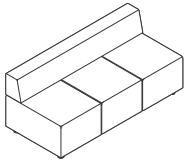

Tip: Recommended leathers are Elmosoft Grade C and Elmorustical Grade E.

Tip: Special color match, consult Customer Service.

Tip: For Customer's Own Material or Leather, see necessary requirements, important processing instructions, and ordering information.  
▶ Page 198

Tip: Contrasting option available only on lounges.

Tip: Please include sketch for ganging.

Tip: Fabrics and leathers will appear loose with comfort wrinkles when upholstered.

	Standard Includes	Required to Specify
▶ Need help? Product details, see <i>Coalesse Seating and Outdoor Specification Guide</i>	<ul style="list-style-type: none"> <li>• Frame: unibody construction with finger-jointed plywood</li> <li>• Multiple densities of polyurethane foam and polyester foam and polyester fiber</li> <li>• Lounge:                             <ul style="list-style-type: none"> <li>- Seat and back: fabric or leather</li> <li>- Legs: black high-density polyurethane resin</li> <li>- Glides: non-adjustable</li> </ul> </li> <li>• Ottoman:                             <ul style="list-style-type: none"> <li>- Seat: fabric or leather</li> <li>- Casters: non-locking</li> </ul> </li> </ul>	<ol style="list-style-type: none"> <li>1 Style number</li> <li>2 Number of fabrics if contrasting fabric style number is selected</li> <li>3 Fabric or leather color number for upholstery on seat and back</li> <li>4 Options, if selected (see below)</li> </ol> ▶ See <i>Surface Materials</i> , page 196.

	Options	Price	Required to Specify
<b>Surface Materials</b>	<ul style="list-style-type: none"> <li>• Contrasting fabric</li> </ul>	+\$167 per fabric	Add suffix K to the style number and select fabric color number.
	<b>Acrylic backer</b> <ul style="list-style-type: none"> <li>• 3-seat lounge</li> <li>• Four-seat lounge</li> <li>• Four-seat bench</li> <li>• Ottoman</li> </ul>	+\$ 77 +\$ 96 +\$ 68 +\$ 22	Specify with <i>acrylic backer</i> . Specify with <i>acrylic backer</i> . Specify with <i>acrylic backer</i> . Specify with <i>acrylic backer</i> . ▶ See <i>Surface Materials</i> , page 196.
<b>Floor Mount Legs</b>	<ul style="list-style-type: none"> <li>• Floor mount legs</li> </ul>	+\$175 per unit	Specify with <i>floor mount legs</i>
<b>Related Products</b>	<ul style="list-style-type: none"> <li>• Connector benches</li> <li>• Occasional tables</li> </ul>		▶ Page 36 ▶ Page 178

# Await Lounge System

DESIGN EOOS

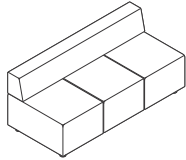

Overall: 30"D 66"W 27"H  
 Inside: 22"D 66"W 27"H  
 Seat: 16½"H  
 Arm: 10½"H

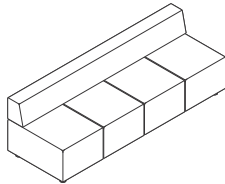

Overall: 30"D 88"W 27"H  
 Inside: 22"D 88"W 27"H  
 Seat: 16½"H  
 Arm: 10½"H

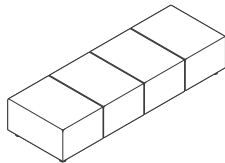

Overall: 30"D 88"W 16½"H  
 Seat: 16½"H



Overall: 22"D 22"W 16½"H

## Specification Information

Style Number	Base Prices										Leather Grades:		
	Fabric Grades:										COL	C	E
	COM	6	7	8	9	10	11	12	13	14			

### 3-Seat Lounge

460-3	\$4750	\$4813	\$4867	\$4954	\$5221	\$5396	\$5599	\$5737	\$5983	\$6330	\$4948	\$ 8455	\$ 9089
COM/yds = 5¾, COL/sq ft = 147													

### Four-Seat Lounge

460-4	\$5794	\$5931	\$5994	\$6106	\$6445	\$6664	\$6916	\$7093	\$7406	\$7843	\$5992	\$10,440	\$11,230
COM/yds = 7¼, COL/sq ft = 185													

### Four-Seat Bench

460-4B	\$4295	\$4348	\$4400	\$4482	\$4739	\$4905	\$5097	\$5232	\$5468	\$5798	\$4493	\$ 7850	\$ 8449
COM/yds = 5½, COL/sq ft = 100													

### Mobile Ottoman

460-H	\$1061	\$1061	\$1075	\$1097	\$1169	\$1212	\$1266	\$1303	\$1365	\$1455	\$1394	\$ 2264	\$ 2422
COM/yds = 1½, COL/sq ft = 33													

# Await Lounge System Connector Benches

DESIGN E00S

*Tip: Recommended leathers are Elmosoft Grade C and Elmorustical Grade E.*

*Tip: Special color match, consult Customer Service.*

*Tip: For Customer's Own Material or Leather, see necessary requirements, important processing instructions, and ordering information.*

► Page 198

*Tip: Please include sketch for ganging.*

*Tip: Fabrics and leathers will appear loose with comfort wrinkles when upholstered.*

## Standard Includes

- Need help?
- Product details, see *Coalesse Seating and Outdoor Specification Guide*
- Bench: fabric or leather
- Frame: unibody construction with finger-jointed plywood
- Multiple densities of polyurethane foam
- Fixed seat
- Top and double needle stitching on seams
- Legs: black high-density polyurethane resin
- Glides

## Required to Specify

- 1 Style number
  - 2 Fabric or leather color number for upholstery on bench
  - 3 Options, if selected (see below)
- See *Surface Materials*, page 196.

## Options Price

Surface Materials	Options	Price	Required to Specify
	<b>Acrylic backer</b>		
	• One-section connector bench	+\$ 30	Specify with acrylic backer.
	• Two-section connector bench	+\$ 46	Specify with acrylic backer.
	• Three-section connector bench	+\$ 70	Specify with acrylic backer.
			► See <i>Surface Materials</i> , page 196.
	<b>Floor Mount Legs</b>		
	• Field-installed Floor mount legs	+\$175 per unit	Specify with floor mount legs.
	<b>Related Products</b>		
	• Occasional tables		► Page 178

## Specification Information

Style Number	Base Prices										Leather Grades:		
	Fabric Grades:										COL	C	E
	COM	6	7	8	9	10	11	12	13	14			

### One-Section Connector Bench

<b>461-1B</b>	\$1960	\$1960	\$1981	\$2015	\$2119	\$2187	\$2267	\$2322	\$2421	\$2555	\$2259	\$3597	\$3835
COM/yds = 2¼, COL/sq ft = 53													

### Two-Section Connector Bench

<b>461-2B</b>	\$3015	\$3015	\$3048	\$3103	\$3279	\$3391	\$3523	\$3612	\$3775	\$4001	\$3240	\$5507	\$5915
COM/yds = 3¾, COL/sq ft = 105													

### Three-Section Connector Bench

<b>461-3B</b>	\$4153	\$4206	\$4258	\$4340	\$4597	\$4763	\$4955	\$5090	\$5326	\$5656	\$4351	\$7552	\$8123
COM/yds = 5½, COL/sq ft = 145													

### Ganging Kit

<b>460-GANGPKG</b>	\$ 67
--------------------	-------

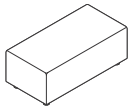

Overall: 44"D 22"W 16½"H

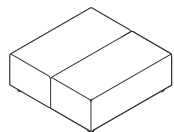

Overall: 44"D 44"W 16½"H

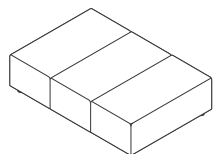

Overall: 44"D 66"W 16½"H

# Await Lounge System Connector Tables

DESIGN EOOS

*Tip: Await connector tables are not recommended to be used in end-of-run applications.*

*Tip: Await connector tables are not made for ganging to Await mobile ottoman.*

Standard Includes	Required to Specify
<ul style="list-style-type: none"> <li>▶ Need help? Product details, see <i>Coalesse Seating and Outdoor Specification Guide</i></li> <li>• Connector table frame: panels are black, white, or gray</li> <li>• Top: High-Pressure Laminate top with matching 3 mm edge band</li> <li>• Glass top (tablet):                             <ul style="list-style-type: none"> <li>- 1/2" thick</li> <li>- Radiused edges</li> </ul> </li> <li>• Ganging plate: 1/4" thick ganging plates attach to the bottom of units to the seating unit plates</li> </ul>	<ol style="list-style-type: none"> <li>1 Style number</li> <li>2 Laminate top and tablets, if selected:                             <ul style="list-style-type: none"> <li>2746 Black</li> <li>2730 Arctic White</li> <li>290N North Sea</li> </ul> </li> <li>3 Glass color number for top, if selected</li> </ol> <p>▶ See <i>Coalesse Surface Materials Reference Guide</i>.</p>

Related Products
<ul style="list-style-type: none"> <li>• Occasional tables ▶ Page 178</li> <li>• Lounge seating ▶ Page 34</li> </ul>

### Specification Information

Style Number	Prices								
	Laminate Top:			Glass Tablet:					
	No Tablet	Tablet	Power/Data	Clear Green/ Frosted Glass Tablet	Clear Green/ Frosted Tablet and Power/Data	Acid Etched 6511 Glass Tablet	Acid Etched 6511 Tablet and Power/Data	Colored Glass Tablet	Colored Tablet and Power/Data
<b>460-SE22</b>	\$ 902	\$2071	N.A.	\$2144	N.A.	\$2173	N.A.	\$2395	N.A.
<b>460-SE22PD</b>	N.A.	N.A.	\$2459	N.A.	\$2604	N.A.	\$2632	N.A.	\$2855

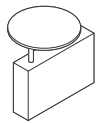

**Overall:** 20"D 4 1/2"W 15 3/4"H  
**With Tablet:** 15 3/4" Dia. and 25 3/8"H

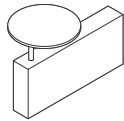

**Overall:** 28"D 4 1/2"W 15 3/4"H  
**With Tablet:** 15 3/4" Dia. and 25 3/8"H

<b>460-SE30</b>	\$1032	\$2201	N.A.	\$2274	N.A.	\$2310	N.A.	\$2525	N.A.
<b>460-SE30PD</b>	N.A.	N.A.	\$2598	N.A.	\$2743	N.A.	\$2771	N.A.	\$2994

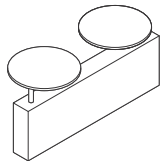

**Overall:** 42"D 4 1/2"W 25 3/8"H  
**With Tablets:** 15 3/4" Dia. and 25 3/8"H

<b>460-SE44</b>	\$1267	\$3605	N.A.	\$3645	N.A.	\$3708	N.A.	\$4146	N.A.
<b>460-SE44PD</b>	N.A.	N.A.	\$3988	N.A.	\$4178	N.A.	\$4240	N.A.	\$4684

# Await Ganging Diagrams by Model (Underside View)

DESIGN E00S

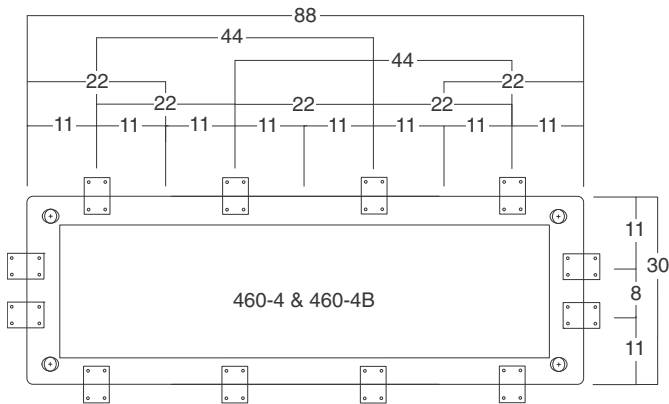
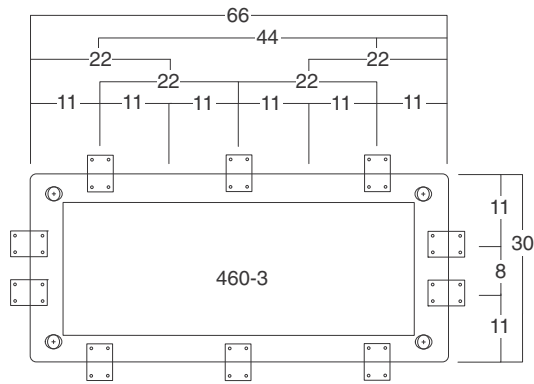
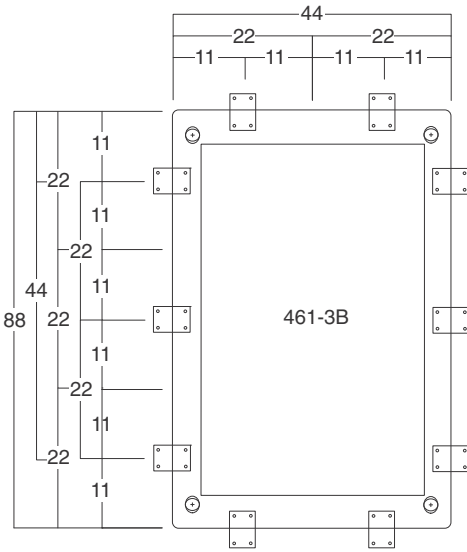
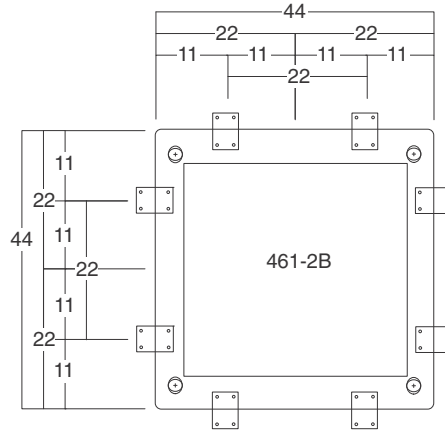
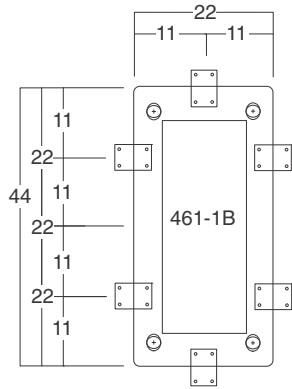

# Await Multi-Fabric Diagram

TO: \_\_\_\_\_

FROM: \_\_\_\_\_

DATE: \_\_\_\_\_

FAX...888.413.5161

**A** Seat (upholstery selections default for entire unit if B is not selected):

\_\_\_\_\_  
\_\_\_\_\_

**B** Back: \_\_\_\_\_

\_\_\_\_\_

*See specifying for contrasting fabric upcharge. List price based on highest fabric grade usage.*

Specify Model below:

460-3K

460-4K

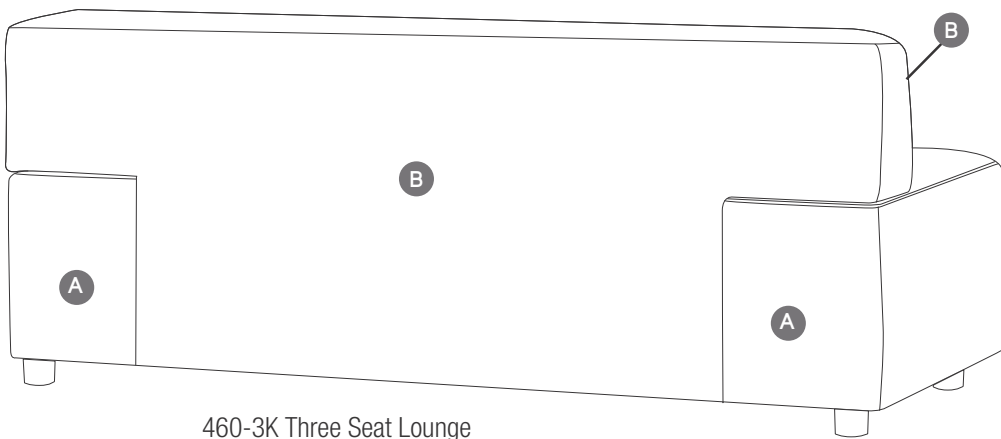
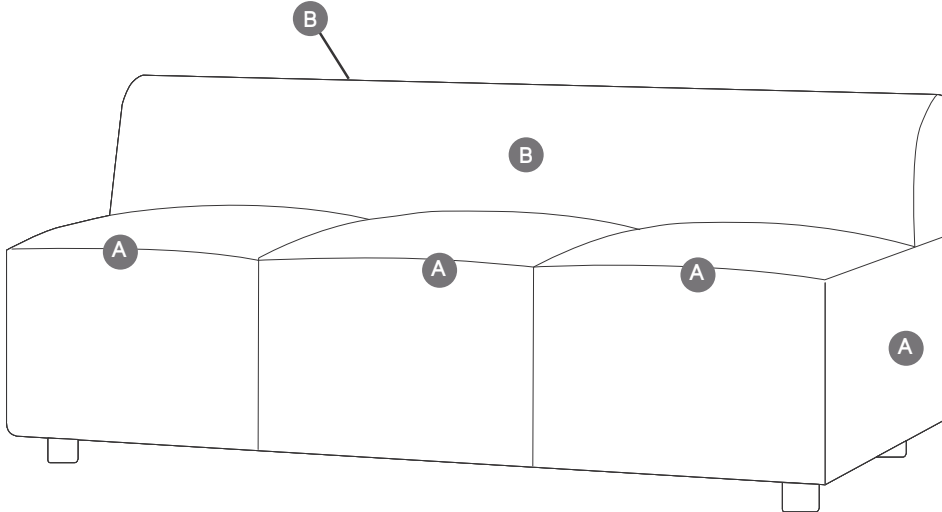

460-3K Three Seat Lounge

# Bix Lounge System Lounge Chairs

DESIGN METRO DESIGN GROUP

*Tip: Fabric for the seat and back is specified separate from the back screen, if selected. For a monochromatic look, specify the same fabric for both the seat and back and back screen.*

*Tip: Fabrics and leathers will appear loose with comfort wrinkles when upholstered.*

*Tip: When specifying fabric in different price grades, the highest price grade prevails.*

*Tip: The COM yards and COL square footage listed on this page reflect the requirements for a single fabric that are based on non-directional 54"W material applied railroaded. For multi-fabric COM requirements, please refer to Multi-Fabric Yardage.*

► Page 48

## Standard Includes

- Need help? Product details, see *Coalesse Seating and Outdoor Specification Guide*
- Seat, back, and arms, if selected: fabric or leather
- Legs: paint
- Adjustable glides: paint to match legs
- Back screen, if selected: fabric

## Required to Specify

- 1 Style number
  - 2 Number of fabrics if contrasting fabric style number is selected
  - 3 Fabric or leather color number for seat, back, and arms, if selected
  - 4 Paint color number for legs and glides
  - 5 Fabric color number for back screen, if selected
  - 6 Options, if selected (see below)
- See *Surface Materials*, page 196.

## Options

Options	Price	Required to Specify
<b>Surface Materials</b>	• Contrasting fabric  • Acrylic backer	• Acrylic backer
	• Lounge chair +\$ 48	• Lounge chair with arms +\$ 68
	• Lounge chair with back screen +\$ 79	
<b>Seat Height</b>	• 18" seat height +\$322	Specify with 18" seat height.
<b>Related Products</b>	• Sectional seating • Bench	► Page 42 ► Page 45

## Specification Information

Style Number	Base Prices										Leather Grades:		
	Fabric Grades:										COL	C	E
	COM	6	7	8	9	10	11	12	13	14			

### Lounge Chair

<b>BL26XX</b>	\$2414	\$2414	\$2438	\$2483	\$2610	\$2693	\$2789	\$2856	\$2977	\$3142	\$2631	\$3887	\$4112
COM/yds = 2¾, COL/sq ft = 55													

### Lounge Chair with Arms

<b>BL26AA</b>	\$3381	\$3381	\$3414	\$3469	\$3645	\$3757	\$3889	\$3978	\$4141	\$4367	\$3682	\$5062	\$5336
COM/yds = 3¾, COL/sq ft = 73													

### Lounge Chair with Back Screen

<b>BLB26XX</b>	\$3482	\$3489	\$3530	\$3598	\$3810	\$3943	\$4101	\$4211	\$4403	\$4673	\$3772	\$5651	\$6017
Chair: COM/yds = 2¾, COL/sq ft = 55													
Screen: COM/yds = 1¾													

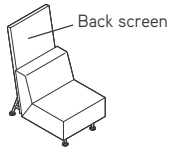
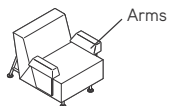
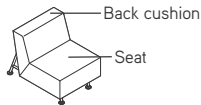



# Bix Lounge System Sled Lounge Chairs

DESIGN METRO DESIGN GROUP

*Tip: The COM yards and COL square footage listed on this page reflect the requirements for a single fabric that are based on non-directional 54"W material applied railroaded. For multi-fabric COM requirements, please refer to Multi-Fabric Yardage.*  
 ▶ Page 48

*Tip: When specifying fabric in different price grades, the highest price grade prevails.*

Standard Includes	Required to Specify
▶ Need help? Product details, see <i>Coalesse Seating and Outdoor Specification Guide</i>	1 Style number 2 Number of fabrics if contrasting fabric style number is selected 3 Fabric or leather color number for seat, back, and arms, if selected 4 Paint color number for base and tablet, if selected 5 Options, if selected (see below) ▶ See <i>Surface Materials</i> , page 196.

Options	Price	Required to Specify
<b>Surface Materials</b> • Contrasting fabric	+\$167 per fabric	Add suffix K to the style number and select fabric color number.
<b>Acrylic backer</b> • Lounge chair and lounge chair with tablet arm • Lounge chair with arms	+\$ 48  +\$ 68	Specify with acrylic backer.  Specify with acrylic backer. ▶ See <i>Surface Materials</i> , page 196.
<b>Related Products</b> • Bench		▶ Page 45

Specification Information														
Style Number	Base Prices												Leather Grades:	
	Fabric Grades:												COL	C
	COM	6	7	8	9	10	11	12	13	14				

## Sled Lounge Chair

<b>BLD26XX</b>	\$2157	\$2157	\$2181	\$2226	\$2353	\$2436	\$2532	\$2599	\$2720	\$2885	\$2279	\$3630	\$3855
COM/yds = 2¾, COL/sq ft = 55													

## Sled Lounge Chair with Arms

<b>BLD26AA</b>	\$3123	\$3123	\$3156	\$3211	\$3387	\$3499	\$3631	\$3720	\$3883	\$4109	\$3275	\$4804	\$5078
COM/yds = 3¾, COL/sq ft = 73													

## Sled Lounge Chair with Left-Hand Facing Tablet Arm

<b>BLD26TX</b>	\$2605	\$2605	\$2629	\$2674	\$2801	\$2884	\$2980	\$3047	\$3168	\$3333	\$2768	\$4078	\$4303
COM/yds = 2¾, COL/sq ft = 55													

## Sled Lounge Chair with Right-Hand Facing Tablet Arm

<b>BLD26XT</b>	\$2605	\$2605	\$2629	\$2674	\$2801	\$2884	\$2980	\$3047	\$3168	\$3333	\$2768	\$4078	\$4303
COM/yds = 2¾, COL/sq ft = 55													

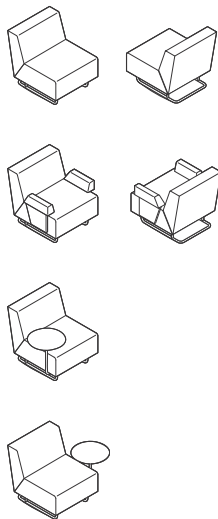

Lounge Seating

# Bix Lounge System Sectional Seating

DESIGN METRO DESIGN GROUP

*Tip: Fabric for the seat and back is specified separate from the back screen, if selected. For a monochromatic look, specify the same fabric for both the seat and back, and back screen.*

*Tip: The COM yards and COL square footage listed on these pages reflect the requirements for a single fabric that are based on non-directional 54"W material applied railroaded. For multi-fabric COM requirements, please refer to Multi-Fabric Yardage.*  
▶Page 48

*Tip: When specifying fabric in different price groups, the highest price group prevails.*

*Tip: Fabrics and leathers will appear loose with comfort wrinkles when upholstered.*

*Tip: Extended corner sections are standard with a railroaded seat and back fabric direction.*  
▶Page 49

*Tip: Fabrics and leathers will appear loose with comfort wrinkles when upholstered.*

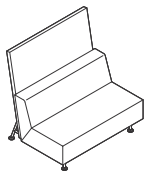
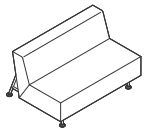
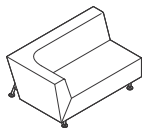
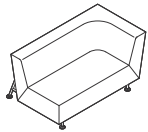

## Standard Includes Required to Specify

▶Need help?  
Product details, see *Coalesse Seating and Outdoor Specification Guide*

- Seat and back, if selected: fabric or leather
- Legs: paint
- Adjustable glides: paint to match legs
- Back screen, if selected: fabric

- 1 Style number
  - 2 Number of fabrics if contrasting fabric style number is selected
  - 3 Fabric or leather color number for seat and back, if selected
  - 4 Paint color number for legs and glides
  - 5 Fabric color number for back screen, if selected
  - 6 Options, if selected (see below)
- ▶See *Surface Materials*, page 196.

## Options Price Required to Specify

Options	Price	Required to Specify
<b>Surface Materials</b>	• Contrasting fabric  <b>Acrylic backer</b>	Add suffix K to the style number and select fabric color number.
	• 48"W sections +\$ 77	Specify with acrylic backer.
	• 48"W sections with back screen +\$ 118	Specify with acrylic backer.
	• 54"W sections +\$ 118	Specify with acrylic backer.
	• 72"W sections +\$103	Specify with acrylic backer.
	• 72"W sections with back screen +\$179	Specify with acrylic backer. ▶See <i>Surface Materials</i> , page 196.
<b>Seat Height</b>	• 18" seat height +\$322	Specify with 18" seat height.
<b>Related Products</b>	• Bench	▶Page 45

## Specification Information

Style Number	Base Prices														Leather Grades:		
	Fabric Grades:														COL	C	E
	COM	6	7	8	9	10	11	12	13	14							

### 54"W Extended Corner Section-Left Section

<b>BSE54LX</b>	\$4748	\$4871	\$4935	\$5042	\$5370	\$5581	\$5824	\$5992	\$6295	\$6717	\$5206	\$7180	\$7589
COM/yds = 7, COL/sq ft = 140													

### 54"W Extended Corner Section-Right Section

<b>BSE54RX</b>	\$4748	\$4871	\$4935	\$5042	\$5370	\$5581	\$5824	\$5992	\$6295	\$6717	\$5206	\$7180	\$7589
COM/yds = 7, COL/sq ft = 140													

### 48"W Straight Section

<b>BSS48XX</b>	\$3575	\$3582	\$3623	\$3691	\$3903	\$4036	\$4194	\$4304	\$4496	\$4766	\$3873	\$5616	\$5960
COM/yds = 4½, COL/sq ft = 90													

### 48"W Straight Section with Back Screen

<b>BSSB48XX</b>	\$4824	\$4970	\$5038	\$5155	\$5505	\$5729	\$5993	\$6175	\$6497	\$6948	\$5292	\$8420	\$9038
Chair: COM/yds = 4½, COL/sq ft = 90													
Screen: COM/yds = 3													

▶Specification Information, continued on next page

# Bix Lounge System Sectional Seating

DESIGN METRO DESIGN GROUP

*Tip: Straight sections are standard with a railroaded seat and back fabric direction.*

**▶ Page 49 Tip:** *Fabrics and leathers will appear loose with comfort wrinkles when upholstered.*

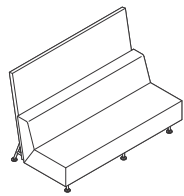
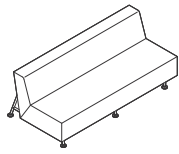

▶ Specification Information, continued from previous page

## Specification Information

Style Number	Base Prices											Leather Grades:			
	Fabric Grades:											COL	C	E	
	6	7	8	9	10	11	12	13	14						

### 72"W Straight Section

<b>BSS72XX</b>	\$4991	\$5093	\$5149	\$5249	\$5554	\$5750	\$5976	\$6133	\$6415	\$6806	\$5479	\$ 7682	\$ 8139
----------------	--------	--------	--------	--------	--------	--------	--------	--------	--------	--------	--------	---------	---------

COM/yds = 6½, COL/sq ft = 130

### 72"W Straight Section with Back Screen

<b>BSSB72XX</b>	\$6656	\$6968	\$7067	\$7236	\$7751	\$8082	\$8466	\$8733	\$9206	\$9868	\$7365	\$11,675	\$12,544
-----------------	--------	--------	--------	--------	--------	--------	--------	--------	--------	--------	--------	----------	----------

Chair: COM/yds = 6½, COL/sq ft = 130  
Screen: COM/yds = 4½

# Bix Multi-Fabric Diagram

DESIGN METRO DESIGN GROUP

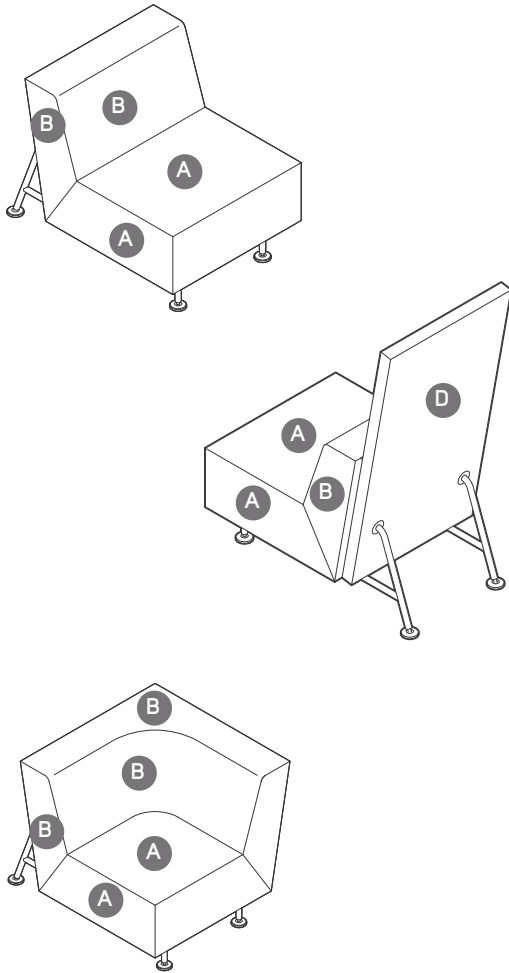

TO: \_\_\_\_\_

FROM: \_\_\_\_\_

DATE: \_\_\_\_\_

FAX...888.413.5161

**A** Seat (upholstery selections default for entire unit if B is not selected): \_\_\_\_\_

**B** Back: \_\_\_\_\_

**C** Arms (if applicable): \_\_\_\_\_

**D** Backscreen (if applicable): \_\_\_\_\_

*\*Back screen defined separately when ordered.*

*See specifying for contrasting fabric upcharge. List price based on highest fabric grade usage.*

# Bix Lounge System Benches

DESIGN METRO DESIGN GROUP

*Tip: Fabrics and leathers will appear loose with comfort wrinkles when upholstered.*

*Tip: The COM yards and COL square footage listed on this page reflect the requirements for a single fabric that are based on non-directional 54"W material applied railroaded.*

Standard Includes		Required to Specify
<ul style="list-style-type: none"> <li>▶ Need help? Product details, see <i>Coalesse Seating and Outdoor Specification Guide</i></li> </ul>	<ul style="list-style-type: none"> <li>• Seat: fabric or leather</li> <li>• Legs and open storage interior, if selected: paint</li> <li>• Adjustable glides: paint to match legs</li> </ul>	<ol style="list-style-type: none"> <li>1 Style number</li> <li>2 Fabric or leather color number for seat</li> <li>3 Paint color number for legs, glides, and open storage interior, if selected</li> <li>4 Options, if selected (see below)</li> </ol> <p>▶ See <i>Surface Materials</i>, page 196.</p>

Options	Price	Required to Specify
<b>Surface Materials</b> <ul style="list-style-type: none"> <li>• Acrylic backer</li> <li>• 48"W benches</li> <li>• 72"W benches</li> </ul>	<ul style="list-style-type: none"> <li>+\$ 30</li> <li>+\$ 43</li> </ul>	<p>Specify with acrylic backer. Specify with acrylic backer. ▶ See <i>Surface Materials</i>, page 196.</p>
<b>Seat Height</b> <ul style="list-style-type: none"> <li>• 18" seat height</li> </ul>	<ul style="list-style-type: none"> <li>+\$322</li> </ul>	<p>Specify with 18" seat height.</p>
<b>Related Products</b> <ul style="list-style-type: none"> <li>• Lounge chairs</li> <li>• Sectional seating</li> </ul>		<p>▶ Page 40 ▶ Page 42</p>

### Specification Information

Style Number	Base Prices										Leather Grades:		
	Fabric Grades:										COL	C	E
COM	6	7	8	9	10	11	12	13	14				

### 48"W Bench

<b>BB48</b>	\$2164	\$2164	\$2185	\$2219	\$2323	\$2391	\$2471	\$2526	\$2625	\$2759	\$2387	\$3530	\$3737
COM/yds = 2¼, COL/sq ft = 41													

### 72"W Bench

<b>BB72</b>	\$2618	\$2618	\$2647	\$2692	\$2830	\$2922	\$3025	\$3100	\$3230	\$3409	\$2865	\$4337	\$4611
COM/yds = 3, COL/sq ft = 54													

### 48"W Bench with Open Storage

<b>BBS48</b>	\$2499	\$2499	\$2520	\$2554	\$2658	\$2726	\$2806	\$2861	\$2960	\$3094	\$2767	\$3865	\$4072
COM/yds = 2¼, COL/sq ft = 41													

### 72"W Bench with Open Storage

<b>BBS72</b>	\$2951	\$2951	\$2980	\$3025	\$3163	\$3255	\$3358	\$3433	\$3563	\$3742	\$3243	\$4670	\$4944
COM/yds = 3, COL/sq ft = 54													

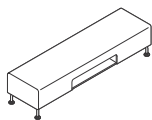
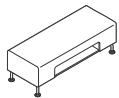
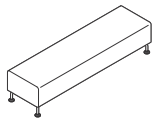
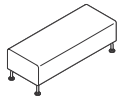

# Bix Multi-Fabric Diagram

DESIGN METRO DESIGN GROUP

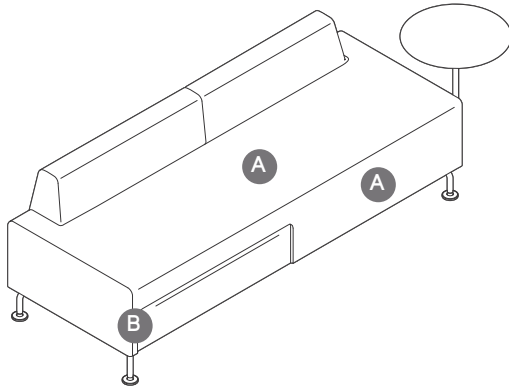

TO: \_\_\_\_\_

FROM: \_\_\_\_\_

DATE: \_\_\_\_\_

FAX....888.413.5161

**A** Seat (upholstery selections default for entire unit if B is not selected): \_\_\_\_\_

**B** Back: \_\_\_\_\_

*See specifying for contrasting fabric upcharge. List price based on highest fabric grade usage.*

# Bix Multi-Fabric Diagram

DESIGN METRO DESIGN GROUP

# Bix Multi-Fabric Yardage

DESIGN METRO DESIGN GROUP

## Multi-Fabric Yardage

DESCRIPTION	STYLE NUMBER	COM YDS*			
		SEAT	BACK	ARM(S)	BACK SCREEN
Lounge chair	BL26XX	1¾	1¾	N.A.	N.A.
Lounge chair with arms	BL26AA	1¾	1¾	1	N.A.
Lounge chair with back screen	BLB26XX	1¾	1¾	N.A.	1¾
Sled lounge chair	BLD26XX	1¾	1¾	N.A.	N.A.
Sled lounge chair with arms	BLD26AA	1¾	1¾	1	N.A.
Sled lounge chair with left-hand tablet arm	BLD26TX	1¾	1¾	N.A.	N.A.
Sled lounge chair with right-hand tablet arm	BLD26XT	1¾	1¾	N.A.	N.A.
54"W extended corner section-left section	BSE54LX	2½	3	N.A.	N.A.
54"W extended corner section-right section	BSE54RX	2½	3	N.A.	N.A.
48"W straight section	BSS48XX	2½	2½	N.A.	N.A.
48"W straight section with back screen	BSSB48XX	2½	2½	N.A.	3
72"W straight section	BSS72XX	4½	4½	N.A.	N.A.
72"W straight section with back screen	BSSB72XX	4½	4½	N.A.	5

\*Fabric yardage is based on non-directional/solid fabrics. use conversion chart on the following page for repeat/printed fabric yardage.



# Bix Multi-Fabric Yardage

DESIGN METRO DESIGN GROUP

## Multi-Fabric Yardage

### Non-standard fabric requirements

Yardage requirements shown are based on non-directional 54"W material applied railroaded. Coalesse will apply fabric railroaded unless instructed otherwise on the dealer's purchase order. The following conversion chart should be used to determine yardage requirements when COM has a repeat of 2" or more. Please contact Coalesse Customer Service for a yardage quotation if the fabric is less than 54" wide, has a repeat of more than 24", or if the fabric must be cut-right.

#### CONVERSION CHART

PRODUCT	REPEAT		
	2" - 8"	9" - 14"	15" - 24"
Bix	15%	30%	75%

Yardage quotations will also be provided for order of 10 or more pieces.

### Pattern matching on Bix

Due to Coalesse's high standards for pattern matching, we reserve the right to apply the following upcharges for extra labor incurred by a pattern or material that poses such challenges.

Customers will be informed if an upcharge will be applied to their order during the approval process. Should Coalesse receive an order without prior approval, it will be held as pending until the customer accepts such charges. The upcharge will be applied per item where applicable.

### Cutting direction guidelines

Cutting direction is based on the fabric width and the way the fabric is cut from the roll and applied to Coalesse products. There are two cutting directions: railroaded or cut-right.

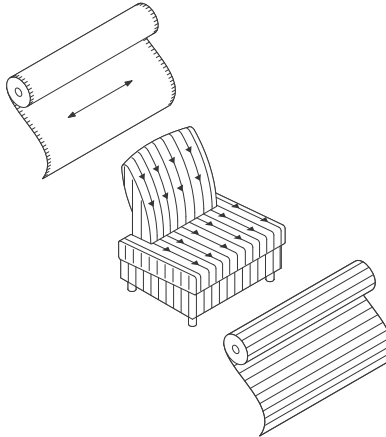

**Horizontal or railroaded** (across roll, warp horizontal) means fabric is cut across the roll; selvages are on the top and bottom.

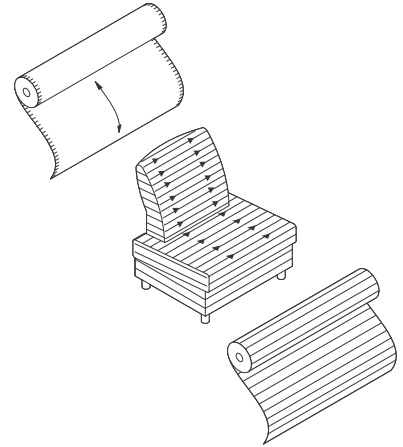

**Vertical or cut-right** (down roll, warp vertical) means fabric is cut in the same direction it is woven; selvages are on the left and right sides.

Coalesse reserves the right to railroad or apply fabric according to weave unless instructions specify otherwise. Fabrics are railroaded when possible to avoid seams in large upholstered areas and/or single cushion units. If a fabric is questionable, a cutting of adequate size showing full repeat (if any) should be sent to Coalesse for a fabric requirement quotation.

# Bob Lounge Chairs by Walter Knoll

DESIGN PEARSON LLOYD

*Tip: For Customer's Own Material or Leather, see necessary requirements, important processing instructions, and ordering information.*  
 ▶ Page 196.

*Tip: Fabrics and leathers will appear loose with comfort wrinkles when upholstered.*

## Standard Includes

- ▶ Need help? Product details, see *Coalesse Seating and Outdoor Specification Guide*
- Base: 8040 Aluminum Matte Polished or grade 1 paint
- Swivel base for lounge chairs, if selected
- Upholstery for chair: fabric or leather
- Glides

## Required to Specify

- 1 Style number
  - 2 Paint or metal color for base
  - 3 Number of fabrics if contrasting fabric style number is selected
  - 4 Fabric or leather color number for upholstery
  - 5 Options, if selected (see below)
- ▶ See *Surface Materials*, page 196.

## Options

Options	Price	Required to Specify
<b>Surface Materials</b>	<ul style="list-style-type: none"> <li>• Contrasting fabric +\$167 per fabric</li> </ul>	Add suffix K to the style number and select fabric color number.
<b>Acrylic backer</b>		Specify with acrylic backer.
<ul style="list-style-type: none"> <li>• Lounge chair +\$ 43</li> <li>• Lounge chair with headrest +\$ 46</li> <li>• Ottoman +\$ 11</li> </ul>		Specify with acrylic backer. ▶ See <i>Surface Materials</i> , page 196.
<b>Base</b>	<ul style="list-style-type: none"> <li><b>Lounge chair with standard swivel mechanism</b></li> <li>• Aluminum matte polished No cost</li> <li>• Grade 1 paint No cost</li> <li>• Grade 3 paint +\$ 96</li> <li><b>Lounge chair with return swivel mechanism</b></li> <li>• Aluminum matte polished +\$324</li> </ul>	Specify with <i>standard swivel</i> and select aluminum matte polished. Specify with <i>standard swivel</i> and select paint color number. Specify with <i>standard swivel</i> and select paint color number. Specify with <i>return swivel</i> and select aluminum matte polished.
<b>Glides</b>	<ul style="list-style-type: none"> <li>• Felted glides +\$ 20</li> </ul>	Specify with <i>felted glides</i> .

## Specification Information

Style Number	Base Prices										Leather Grades:		
	Fabric Grades:										COL	C	E
	COM	6	7	8	9	10	11	12	13	14			

### Lounge Chair

216	\$3085	\$3085	\$3114	\$3159	\$3297	\$3389	\$3492	\$3567	\$3697	\$3876	\$3334	\$5043	\$5354
-----	--------	--------	--------	--------	--------	--------	--------	--------	--------	--------	--------	--------	--------

COM/yds = 3, COL/sq ft = 72



Overall: 34¼"D 35"W 31¾"H  
 Inside: 21¾"D 20"W 17¼"H  
 Seat: 17"H  
 Arm: 21¾"H

### Lounge Chair with Headrest

221	\$3656	\$3656	\$3687	\$3742	\$3905	\$4009	\$4132	\$4217	\$4370	\$4577	\$3880	\$5883	\$6245
-----	--------	--------	--------	--------	--------	--------	--------	--------	--------	--------	--------	--------	--------

COM/yds = 3½, COL/sq ft = 77



Overall: 34¼"D 35"W 41¼"H  
 Inside: 21¾"D 20"W 27½"H  
 Seat: 17"H  
 Arm: 21¾"H

▶ Specification Information, continued on next page

# Bob Lounge Chairs by Walter Knoll

DESIGN PEARSON LLOYD

► Specification Information, continued from previous page

## Specification Information

Style Number	Base Prices											Leather Grades:		
	Fabric Grades:											COL	C	E
	COM	6	7	8	9	10	11	12	13	14				

### Ottoman

221-H	\$1135	\$1127	\$1136	\$1152	\$1199	\$1228	\$1263	\$1288	\$1332	\$1392	\$1470	\$1992	\$2094
COM/yds = 1, COL/sq ft = 22													



Overall: 18½"D 19¾"W 15¼"H

# Circa Lounge System Upholstered Individual Lounge Units

DESIGN ALISON SPEAR, AIA

*Tip: Fabrics and leathers will appear loose with comfort wrinkles when upholstered.*

*Tip: For contrasting fabric, pricing is based on highest grade textile specified.*

*Tip: For Customer's Own Material or Leather, see necessary requirements, important processing instructions, and ordering information*  
 ▶Page 198

*Tip: Benches are flat and 1-seat and 2-seat lounges are angled; therefore, seat angles will not be aligned when placed next to each other. A table is recommended between the units to minimize the difference.*

Standard Includes		Required to Specify
▶ Need help? Product details, see <i>Coalesse Seating and Outdoor Specification Guide</i>	<ul style="list-style-type: none"> <li>• Frame: unibody construction of hardwood plywood utilizing box joinery</li> <li>• Upholstery: multiple densities of polyurethane foam fixed seat and back with top stitch on seams</li> <li>• Legs:                             <ul style="list-style-type: none"> <li>- Tapered leg, if selected: solid maple or walnut</li> <li>- Cylinder leg, if selected: solid oak</li> </ul> </li> </ul>	1 Style number 2 Number of fabrics if contrasting fabric style number is selected 3 Fabric or leather color number for upholstery on seat and back 4 Wood leg type 5 Wood color number for legs 6 Options, if selected (see below) ▶ See <i>Surface Materials</i> , page 196.

Options	Price	Required to Specify
<b>Surface Materials</b>	<ul style="list-style-type: none"> <li>• Contrasting fabric +\$167 per fabric</li> </ul>	Add suffix K to the style number and select fabric color number.
<b>Acrylic backer</b>		
<ul style="list-style-type: none"> <li>• 30° outside facing wedge 1-seat lounge +\$ 45</li> <li>• 30° inside facing wedge seat 1-seat lounge +\$ 46</li> <li>• 60° outside and inside wedge 2-seat lounge +\$ 81</li> <li>• 60° benches +\$ 55</li> <li>• Straight 1-seat lounge +\$ 30</li> <li>• Straight 2-seat lounge +\$ 68</li> <li>• Straight bench +\$ 43</li> </ul>		Specify with acrylic backer. Specify with acrylic backer. Specify with acrylic backer. Specify with acrylic backer. Specify with acrylic backer. Specify with acrylic backer. ▶ See <i>Surface Materials</i> , page 196.
<b>Shared Leg Application</b>	<ul style="list-style-type: none"> <li>• Cylinder wood legs -\$248</li> <li>• Modern metal legs -\$248</li> </ul>	Specify with cylinder wood legs. Specify with modern metal legs.
<b>Metal Legs</b>	<ul style="list-style-type: none"> <li><b>Tapered legs</b></li> <li>• Grade 1 paint +\$187 per leg</li> <li>• Grade 3 paint +\$213 per leg</li> <li><b>Modern legs</b></li> <li>• Grade 1 paint +\$187 per unit</li> <li>• Grade 3 paint +\$213 per leg</li> </ul>	Specify with tapered metal legs and select paint color number. ▶ See <i>Surface Materials</i> , page 196. Specify with tapered metal legs and select paint color number. ▶ See <i>Surface Materials</i> , page 196. Specify with modern metal legs and select paint color number. ▶ See <i>Surface Materials</i> , page 196. Specify with modern metal legs and select paint color number. ▶ See <i>Surface Materials</i> , page 196.

Specification Information													
Style Number	Base Prices											Leather Grades:	
	Fabric Grades:											COL	C
COM	6	7	8	9	10	11	12	13	14				

## 30° Outside Facing Wedge 1-Seat Lounge

451-3730FO	\$1907	\$1907	\$1939	\$1988	\$2141	\$2236	\$2350	\$2430	\$2572	\$2767	\$2204	\$4336	\$4728
------------	--------	--------	--------	--------	--------	--------	--------	--------	--------	--------	--------	--------	--------

COM/yds = 3¼, COL/sq ft = 72

▶ Specification Information, continued on next page

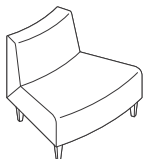

Overall: 28"D 36¾"W 29½"H  
 Inside: 20"D 36¾"W 12¼"H  
 Seat: 17¼"H  
 Angle Degree: 30°

# Circa Lounge System Upholstered Individual Lounge Units

DESIGN ALISON SPEAR, AIA

► Specification Information, continued from previous page

**Specification Information**

Style Number	Base Prices										Leather Grades:		
	Fabric Grades:										COL	C	E
	COM	6	7	8	9	10	11	12	13	14			

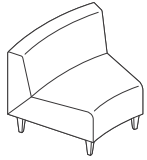

Overall: 28"D 36¾"W 29½"H  
 Inside: 20"D 36¾"W 12¼"H  
 Seat: 17¼"H  
 Angle Degree: 30°

## 30° Inside Facing Wedge 1-Seat Lounge

<b>451-3730FI</b>	\$1907	\$1907	\$1939	\$1988	\$2141	\$2236	\$2350	\$2430	\$2572	\$2767	\$2204	\$4336	\$4728
-------------------	--------	--------	--------	--------	--------	--------	--------	--------	--------	--------	--------	--------	--------

COM/yds = 3¾, COL/sq ft = 72

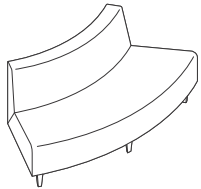

Overall: 28"D 71"W 29½"H  
 Inside: 20"D 71"W 12¼"H  
 Seat: 17¼"H  
 Angle Degree: 60°

## 60° Outside Wedge 2-Seat Lounge

<b>451-7460FO</b>	\$3033	\$3135	\$3191	\$3291	\$3596	\$3792	\$4018	\$4175	\$4457	\$4848	\$3263	\$7604	\$8382
-------------------	--------	--------	--------	--------	--------	--------	--------	--------	--------	--------	--------	--------	--------

COM/yds = 4½, COL/sq ft = 99

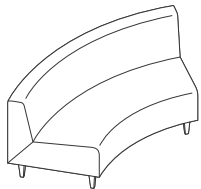

Overall: 28"D 71"W 29½"H  
 Inside: 20"D 71"W 12¼"H  
 Seat: 17¼"H  
 Angle Degree: 60°

## 60° Inside Wedge 2-Seat Lounge

<b>451-7460FI</b>	\$3033	\$3135	\$3191	\$3291	\$3596	\$3792	\$4018	\$4175	\$4457	\$4848	\$3263	\$7604	\$8382
-------------------	--------	--------	--------	--------	--------	--------	--------	--------	--------	--------	--------	--------	--------

COM/yds = 4¾, COL/sq ft = 105

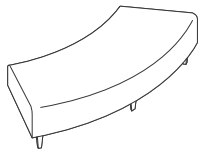

Overall: 28"D 71"W 17¼"H  
 Seat: 17¼"H  
 Angle Degree: 60°

## 60° Outside Wedge Bench

<b>451-B7460FO</b>	\$2404	\$2404	\$2433	\$2478	\$2616	\$2708	\$2811	\$2886	\$3016	\$3195	\$2705	\$4670	\$5037
--------------------	--------	--------	--------	--------	--------	--------	--------	--------	--------	--------	--------	--------	--------

COM/yds = 3, COL/sq ft = 66

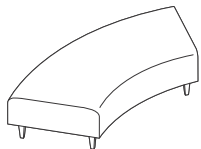

Overall: 28"D 71"W 17¼"H  
 Seat: 17¼"H  
 Angle Degree: 60°

## 60° Inside Wedge Bench

<b>451-B7460FI</b>	\$2404	\$2404	\$2433	\$2478	\$2616	\$2708	\$2811	\$2886	\$3016	\$3195	\$2705	\$4670	\$5037
--------------------	--------	--------	--------	--------	--------	--------	--------	--------	--------	--------	--------	--------	--------

COM/yds = 3, COL/sq ft = 66

► Specification Information, continued on next page

Lounge Seating

# Circa Lounge System Upholstered Individual Lounge Units *continued*

DESIGN ALISON SPEAR, AIA

► Specification Information, continued from previous page

## Specification Information

Style Number	Base Prices											Leather Grades:		
	Fabric Grades:											COL	C	E
	COM	6	7	8	9	10	11	12	13	14				

### Straight 1-Seat Lounge

451-2500	\$1714	\$1714	\$1735	\$1775	\$1891	\$1966	\$2051	\$2114	\$2222	\$2370	\$2037	\$3658	\$3958
----------	--------	--------	--------	--------	--------	--------	--------	--------	--------	--------	--------	--------	--------

COM/yds = 2½, COL/sq ft = 55

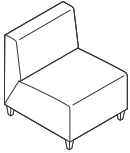

Overall: 28"D 25"W 29½"H  
 Inside: 20"D 25"W 12¼"H  
 Seat: 17¼"H  
 Angle Degree: 0°

### Straight 2-Seat Lounge

451-5000	\$2460	\$2488	\$2534	\$2611	\$2845	\$2993	\$3171	\$3293	\$3507	\$3809	\$2696	\$6015	\$6614
----------	--------	--------	--------	--------	--------	--------	--------	--------	--------	--------	--------	--------	--------

COM/yds = 4, COL/sq ft = 83

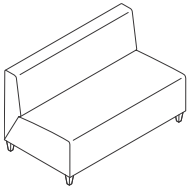

Overall: 28"D 50"W 29½"H  
 Inside: 20"D 50"W 12¼"H  
 Seat: 17¼"H  
 Angle Degree: 0°

### Straight Bench

451-B5000	\$2190	\$2190	\$2219	\$2264	\$2402	\$2494	\$2597	\$2672	\$2802	\$2981	\$2485	\$4463	\$4811
-----------	--------	--------	--------	--------	--------	--------	--------	--------	--------	--------	--------	--------	--------

COM/yds = 3, COL/sq ft = 66

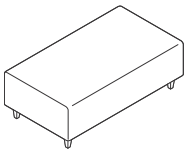

Overall: 28"D 50"W 17¼"H  
 Seat: 17¼"H  
 Angle Degree: 0°

*Tip: Please submit sketch for modular application. One package is required per two chairs.*

### Ganging Kit

451-GANGPKG	\$ 51	N.A.	N.A.	N.A.	N.A.	N.A.	N.A.	N.A.	N.A.	N.A.	N.A.	N.A.	N.A.
-------------	-------	------	------	------	------	------	------	------	------	------	------	------	------

Coalesse SIN 33721

# Circa Lounge System Upholstered Individual Lounge Units

DESIGN ALISON SPEAR, AIA

# Circa Lounge System Upholstered Modular Arm Rests—Straight, 15°, 30°, and Ottoman

DESIGN ALISON SPEAR, AIA

*Tip: Fabrics and leathers will appear loose with comfort wrinkles when upholstered.*

*Tip: Cylinder wood and modern metal legs cannot be in shared position with armrests. The legs will always be on the lounge side.*

*Tip: For Customer's Own Material or Leather, see necessary requirements, important processing instructions, and ordering information*  
▶ Page 198

Standard Includes		Required to Specify
▶ Need help? Product details, see <i>Coalesse Seating and Outdoor Specification Guide</i>	<ul style="list-style-type: none"> <li>• Frame: hardwood panels</li> <li>• Upholstery: multiple densities of polyurethane</li> <li>• Top stitch on seams</li> <li>• Legs:                             <ul style="list-style-type: none"> <li>- Tapered leg, if selected: solid maple or walnut</li> <li>- Cylinder leg, if selected: solid oak</li> </ul> </li> </ul>	1 Style number 2 Fabric or leather color number for arm rests 3 Wood leg type 4 Wood color number for legs 5 Options, if selected (see below) ▶ See <i>Surface Materials</i> , page 196.

Options	Price	Required to Specify
<b>Surface Materials</b>	<ul style="list-style-type: none"> <li>• Contrasting fabric on ottoman +\$167</li> </ul>	Add suffix K to the style number and select fabric color number.
	<b>Acrylic backer</b>	Specify with <i>acrylic backer</i> .
	<ul style="list-style-type: none"> <li>• Straight armrests and 15° armrests +\$ 26</li> <li>• 30° armrests and ottoman +\$ 45</li> </ul>	▶ See <i>Surface Materials</i> , page 196. Specify with <i>acrylic backer</i> . ▶ See <i>Surface Materials</i> , page 196.
<b>Metal Legs</b>	<b>Tapered legs</b>	Specify with <i>tapered metal legs</i> and select paint color number.
	<ul style="list-style-type: none"> <li>• Grade 1 paint +\$187 per leg</li> <li>• Grade 3 paint +\$213 per leg</li> </ul>	▶ See <i>Surface Materials</i> , page 196. Specify with <i>tapered metal legs</i> and select paint color number. ▶ See <i>Surface Materials</i> , page 196.
	<b>Modern legs</b>	Specify with <i>modern metal legs</i> and select paint color number.
	<ul style="list-style-type: none"> <li>• Grade 1 paint +\$187 per leg</li> <li>• Grade 3 paint +\$213 per leg</li> </ul>	▶ See <i>Surface Materials</i> , page 196. Specify with <i>modern metal legs</i> and select paint color number. ▶ See <i>Surface Materials</i> , page 196.

Specification Information														
Style Number	Base Prices												Leather Grades:	
	Fabric Grades:	COM	6	7	8	9	10	11	12	13	14	COL	C	E

Straight Armrest—Intermediate without Legs														
451-A1800G	\$1057	\$1057	\$1078	\$1112	\$1216	\$1284	\$1364	\$1419	\$1518	\$1652	\$1342	\$2607	\$2839	
COM/yds = 2¼, COL/sq ft = 50														

Straight Armrest—End of Run with Two Legs														
451-A1800ER	\$1224	\$1224	\$1245	\$1279	\$1383	\$1451	\$1531	\$1586	\$1685	\$1819	\$1509	\$2774	\$3006	
COM/yds = 2¼, COL/sq ft = 50														

15° Inside Armrest—Intermediate without Legs														
451-A1815FIG	\$1047	\$1047	\$1066	\$1094	\$1188	\$1249	\$1320	\$1368	\$1453	\$1573	\$1342	\$2459	\$2662	
COM/yds = 2, COL/sq ft = 44														

15° Inside Armrest—End of Run with Two Legs														
451-A1815FIER	\$1286	\$1286	\$1305	\$1333	\$1427	\$1488	\$1559	\$1607	\$1692	\$1812	\$1581	\$2698	\$2901	
COM/yds = 2, COL/sq ft = 44														

▶ Specification Information, continued on next page



Overall: 28"D 18½"W 17"H



Overall: 28"D 18½"W 23½"H  
*Tip: Specify left or right facing.*



Overall: 28¾"D 18½"W 23½"H



Overall: 28¾"D 18½"W 23½"H  
*Tip: Specify left or right facing.*



# Circa Lounge System Upholstered Modular Arm Rests—Straight, 15°, 30°, and Ottoman

DESIGN ALISON SPEAR, AIA

► Specification Information, continued from previous page

## Specification Information

Style Number	Base Prices											Leather Grades:		
	Fabric Grades:											COL	C	E
	COM	6	7	8	9	10	11	12	13	14				

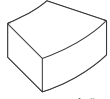

Overall: 29½"D 36¾"W 17"H

### 30° Inside Arm Rest—Intermediate without Legs

451-A3730FIG	\$1494	\$1494	\$1523	\$1568	\$1706	\$1798	\$1901	\$1976	\$2106	\$2285	\$1743	\$3452	\$3763
--------------	--------	--------	--------	--------	--------	--------	--------	--------	--------	--------	--------	--------	--------

COM/yds = 3, COL/sq ft = 66

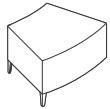

Overall: 29½"D 36¾"W 23½"H  
Tip: Specify left or right facing.

### 30° Inside Arm Rest—End of Run with Two Legs

451-A3730FIER	\$1676	\$1676	\$1705	\$1750	\$1888	\$1980	\$2083	\$2158	\$2288	\$2467	\$1925	\$3634	\$3945
---------------	--------	--------	--------	--------	--------	--------	--------	--------	--------	--------	--------	--------	--------

COM/yds = 3, COL/sq ft = 66



Overall: 28¾"D 18½"W 17"H

### 15° Outside Armrest—Intermediate without Legs

451-A1815FOG	\$1047	\$1047	\$1066	\$1094	\$1188	\$1249	\$1320	\$1368	\$1453	\$1573	\$1342	\$2459	\$2662
--------------	--------	--------	--------	--------	--------	--------	--------	--------	--------	--------	--------	--------	--------

COM/yds = 2, COL/sq ft = 44



Overall: 28¾"D 18½"W 23½"H  
Tip: Specify left or right facing.

### 15° Outside Armrest—End of Run with Two Legs

451-A1815FOER	\$1286	\$1286	\$1305	\$1333	\$1427	\$1488	\$1559	\$1607	\$1692	\$1812	\$1581	\$2698	\$2901
---------------	--------	--------	--------	--------	--------	--------	--------	--------	--------	--------	--------	--------	--------

COM/yds = 2, COL/sq ft = 44

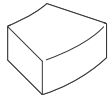

Overall: 29½"D 36¾"W 17"H

### 30° Outside Arm Rest—Intermediate without Legs

451-A3730FOG	\$1494	\$1494	\$1523	\$1568	\$1706	\$1798	\$1901	\$1976	\$2106	\$2285	\$1743	\$3452	\$3763
--------------	--------	--------	--------	--------	--------	--------	--------	--------	--------	--------	--------	--------	--------

COM/yds = 3, COL/sq ft = 66

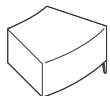

Overall: 29½"D 36¾"W 23½"H  
Tip: Specify left or right facing.

### 30° Outside Arm Rest—End of Run with Two Legs

451-A3730FOER	\$1676	\$1676	\$1705	\$1750	\$1888	\$1980	\$2083	\$2158	\$2288	\$2467	\$1925	\$3634	\$3945
---------------	--------	--------	--------	--------	--------	--------	--------	--------	--------	--------	--------	--------	--------

COM/yds = 3, COL/sq ft = 66

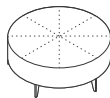

Overall: 42"Dia. 17"H

### Round Ottoman with Five Legs

451-B42RD	\$2283	\$2283	\$2315	\$2364	\$2517	\$2612	\$2726	\$2806	\$2948	\$3143	\$2522	\$4384	\$4715
-----------	--------	--------	--------	--------	--------	--------	--------	--------	--------	--------	--------	--------	--------

COM/yds = 3¼, COL/sq ft = 72

Tip: Please submit sketch for modular application. One kit is required per two chairs.

### Ganging Kit

451-GANGPKG	\$ 51	N.A.	N.A.	N.A.	N.A.	N.A.	N.A.	N.A.	N.A.	N.A.	N.A.	N.A.	N.A.
-------------	-------	------	------	------	------	------	------	------	------	------	------	------	------

# Circa Lounge System Modular Tables

DESIGN ALISON SPEAR, AIA

Standard Includes	Required to Specify
<ul style="list-style-type: none"> <li>▶ Need help? Product details, see <i>Coalesse Seating and Outdoor Specification Guide</i></li> <li>• Table: hardwood veneer</li> <li>• Legs:                             <ul style="list-style-type: none"> <li>- Tapered leg, if selected: solid maple or walnut</li> <li>- Cylinder leg, if selected: solid oak</li> </ul> </li> <li>• Brackets and hardware, if ganging or end-of-run tables selected</li> </ul>	<ol style="list-style-type: none"> <li>1 Style number</li> <li>2 Wood color number for table</li> <li>3 Wood leg type</li> <li>4 Wood color number for legs</li> <li>5 Options, if selected (see below)</li> </ol> <p>▶ See <i>Surface Materials</i>, page 196.</p>

Options	Price	Required to Specify
<b>Surface Materials</b> <b>Table</b> <ul style="list-style-type: none"> <li>• Laminate with self edge</li> </ul>	Prices below and at right	Specify with <i>laminate</i> and select laminate color number. ▶ See <i>Surface Materials</i> , page 196.
<b>Metal Legs</b> <b>Tapered legs</b> <ul style="list-style-type: none"> <li>• Grade 1 paint</li> </ul>	+\$187 per leg	Specify with <i>tapered metal legs</i> and select paint color number. ▶ See <i>Surface Materials</i> , page 196.
<b>Modern legs</b> <ul style="list-style-type: none"> <li>• Grade 1 paint</li> </ul>	+\$187 per leg	Specify with <i>modern metal legs</i> and select paint color number. ▶ See <i>Surface Materials</i> , page 196.

### Specification Information

Style Number	Base Prices	
	Laminate	Wood Veneer

### 15° Low Wedge Table, Ganging

45-T1815LG	\$1612	\$1856
------------	--------	--------

### 15° Low Wedge Table, End-of-Run, Two Legs

45-T1815LER	\$1726	\$2106
-------------	--------	--------

### 15° High Wedge Table, Ganging

45-T1815HG	\$2045	\$2562
------------	--------	--------

### 15 High Wedge Table, End-of-Run, Two Legs

45-T1815HER	\$2157	\$2801
-------------	--------	--------

### 15° High Wedge Table, Freestanding, Four Legs

45-T1815H	\$2269	\$3056
-----------	--------	--------

▶ Specification Information, continued on next page

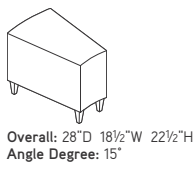
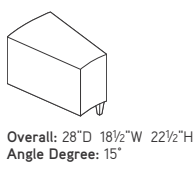
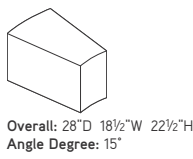
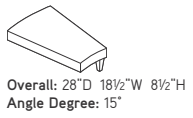
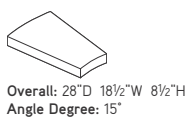

# Circa Lounge System Modular Tables

DESIGN ALISON SPEAR, AIA

► Specification Information, continued from previous page

## Specification Information

Style Number	Base Prices	
	Laminate	Wood Veneer

### 30° Low Wedge Table, Ganging

45-T3730LG	\$2021	\$2273
------------	--------	--------

### 30° Low Wedge Table, End-of-Run, Two Legs

45-T3730LER	\$2136	\$2543
-------------	--------	--------

### 30° High Wedge Table, Ganging

45-T3730HG	\$2837	\$3239
------------	--------	--------

### 30° High Wedge Table, End-of-Run, Two Legs

45-T3730HER	\$2952	\$3503
-------------	--------	--------

### Straight Low Table, Ganging

45-T1300LG	\$1610	\$1814
------------	--------	--------

### Straight Low Table, End-of-Run, Two Legs

45-T1300LER	\$1726	\$2106
-------------	--------	--------

### Straight High Table, Ganging

45-T1300HG	\$2367	\$2905
------------	--------	--------

### Straight High Table, End-of-Run, Two Legs

45-T1300HER	\$2682	\$3401
-------------	--------	--------

► Specification Information, continued on next page

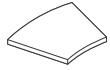

Overall: 29"D 36<sup>5</sup>/<sub>8</sub>"W 2"H  
(8<sup>1</sup>/<sub>2</sub>" from floor once assembled)

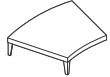

Overall: 29"D 36<sup>5</sup>/<sub>8</sub>"W 8<sup>1</sup>/<sub>2</sub>"H

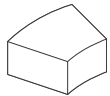

Overall: 29"D 36<sup>5</sup>/<sub>8</sub>"W 16"H

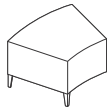

Overall: 29"D 36<sup>5</sup>/<sub>8</sub>"W 22<sup>1</sup>/<sub>2</sub>"H

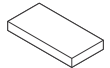

Overall: 27<sup>1</sup>/<sub>2</sub>"D 13<sup>1</sup>/<sub>2</sub>"W 8<sup>1</sup>/<sub>2</sub>"H  
Angle Degree: 0°

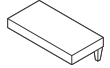

Overall: 27<sup>1</sup>/<sub>2</sub>"D 13<sup>1</sup>/<sub>2</sub>"W 8<sup>1</sup>/<sub>2</sub>"H  
Angle Degree: 0°

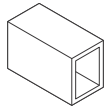

Overall: 27<sup>1</sup>/<sub>2</sub>"D 13<sup>1</sup>/<sub>2</sub>"W 22<sup>1</sup>/<sub>2</sub>"H  
Angle Degree: 0°

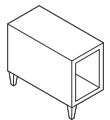

Overall: 27<sup>1</sup>/<sub>2</sub>"D 13<sup>1</sup>/<sub>2</sub>"W 22<sup>1</sup>/<sub>2</sub>"H  
Angle Degree: 0°

# Circa Lounge System Modular Tables *continued*

DESIGN ALISON SPEAR, AIA

► Specification Information, continued from previous page

## Specification Information

Style Number	Base Prices	
	Laminate	Wood Veneer

### Straight High Table, Freestanding, Four Legs

45-T1300H	\$2794	\$3604
-----------	--------	--------

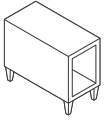

Overall: 27½"D 13½"W 22½"H  
Angle Degree: 0°

### 30° End-of-Run, One Leg

45-T28HER	\$2225	\$2745
-----------	--------	--------



Overall: 13¾"D 27½"W 22¼"H  
(8½" from floor once assembled)  
Tip: Model 45-T28HER has only a single width tapered leg, no corner.

#### Options for Creating 90° Applications:

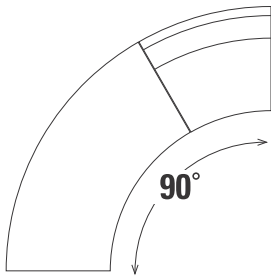

- (1) 30° Outside or Inside Facing Wedge Seat
- (1) 60° Wedge Bench

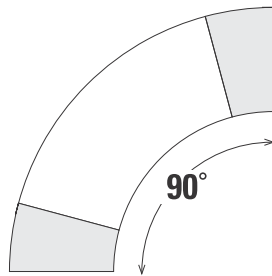

- (2) 15° Wedge Tables
- (1) 60° Wedge Bench

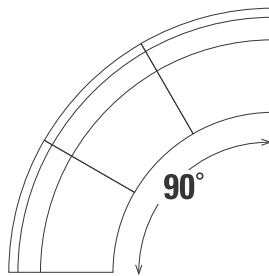

- (3) 30° Outside or Inside Facing Wedge Seats

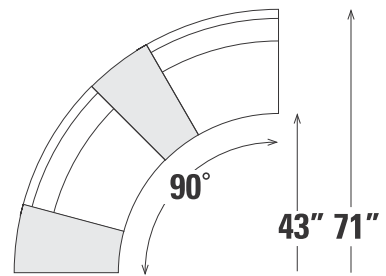

- (2) 30° Outside or Inside Facing Wedge Seats
- (2) 15° Wedge Tables

# Circa Lounge System Freestanding Round Table

DESIGN ALISON SPEAR, AIA

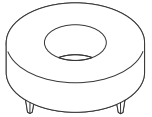

Overall: 42" dia. 15¾"H

Tip: Tapered wood and metal legs have a thin, blade aesthetic.

Tip: The round plate that houses the power/data module is powder coated to complement the power/data module finish. For the black anodized aluminum module, the round plate will be painted in 4710 Low Gloss Black. For the silver anodized aluminum module, the round plate will be painted 4799 Platinum.

Standard Includes	Required to Specify
-------------------	---------------------

- |  |   |
|--|---|
| <ul style="list-style-type: none"> <li>▶ Need help? Product details, see <i>Coalesse Seating and Outdoor Specification Guide</i></li> <li>• Table: laminate</li> <li>• Legs:                             <ul style="list-style-type: none"> <li>- Tapered leg, if selected: solid maple or walnut</li> <li>- Cylinder leg, if selected: solid oak</li> </ul> </li> </ul> | <ol style="list-style-type: none"> <li>1 Style number</li> <li>2 Wood color number for table</li> <li>3 Wood leg type</li> <li>4 Wood color number for legs</li> <li>5 Options, if selected (see below)</li> </ol> <p>▶ See <i>Surface Materials</i>, page 196.</p> |
|--|---|

Options	Price	Required to Specify
---------	-------	---------------------

<b>Surface Materials</b>	<b>Table</b> <ul style="list-style-type: none"> <li>• Wood veneer</li> <li>• Sunburst wood veneer</li> </ul>	Price below Price below	Specify with <i>wood veneer</i> and select wood color number. ▶ See <i>Surface Materials</i> , page 196. Specify with <i>sunburst wood veneer</i> and select wood color number. ▶ See <i>Surface Materials</i> , page 196.
<b>Metal Legs</b>	<b>Tapered legs</b> <ul style="list-style-type: none"> <li>• Grade 1 paint</li> </ul>	+\$187 per leg	Specify with <i>tapered metal legs</i> and select paint color number. ▶ See <i>Surface Materials</i> , page 196.
	<b>Modern legs</b> <ul style="list-style-type: none"> <li>• Grade 1 paint</li> </ul>	+\$187 per leg	Specify with <i>modern metal legs</i> and select paint color number. ▶ See <i>Surface Materials</i> , page 196.
<b>Glass Insert</b>	<ul style="list-style-type: none"> <li>• Green tinted glass insert ¾" thick with white enamel bottom square edge detail</li> </ul>	+\$366	Specify with <i>glass insert</i> .
<b>Power/Data Module</b>	<ul style="list-style-type: none"> <li>• Two power/two data ports black anodized aluminum or silver anodized aluminum</li> </ul>	+\$543	Specify finish color number.

### Specification Information

Style Number	Base Prices		
	Laminate	Wood Veneer	Sunburst Wood Veneer

### Round Table, Freestanding, Four Legs

45-T42RD	\$3828	\$5104	\$5499
----------	--------	--------	--------

# Circa Lounge System Multi-Fabric Diagram

DESIGN ALISON SPEAR, AIA

Applies to all Circa models including: Straight 1-Seat Lounge, Wedge, and Straight 2-Seat Lounge

TO: \_\_\_\_\_

FROM: \_\_\_\_\_

DATE: \_\_\_\_\_

FAX...888.413.5161

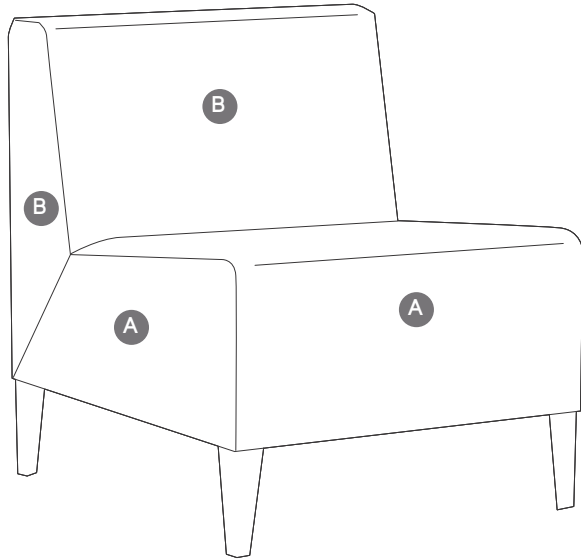

**A** Upholstery Selection (default for entire unit if B is not selected):

\_\_\_\_\_

\_\_\_\_\_

**B** Back: \_\_\_\_\_

\_\_\_\_\_

*See specifying for contrasting fabric upcharge. List price based on highest fabric grade usage.*

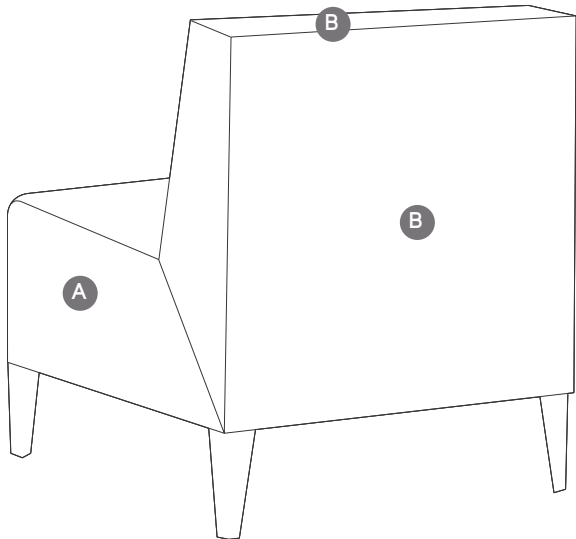

Specify model below:

- 451-7460FOK Outside Facing
- 451-7460FIK Inside Facing
- 451-5000K
- 451-2500K
- 451-3730FOK Outside Facing
- 451-3730FIK Inside Facing

# Coupe

DESIGN DENNIE PIMENTAL / JOHN DUFFY

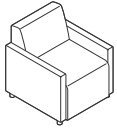

Overall: 28"D 26½"W 30"H  
 Inside: 20"D 22"W 13"H  
 Seat: 17"H  
 Arm: 22"H

*Tip: Fabrics and leathers will appear loose with comfort wrinkles when upholstered.*

*Tip: Recommended leathers are Elmosoft Grade C and Elmorustical Grade E.*

*Tip: Special color match, consult Customer Service.*

*Tip: For Customer's Own Material or Leather, see necessary requirements, important processing instructions, and ordering information.*

►Page 198

Standard Includes		Required to Specify
► Need help? Product details, see <i>Coalesse Seating and Outdoor Specification Guide</i>	<ul style="list-style-type: none"> <li>• Frame: unibody construction of hardwood plywood utilizing box joinery</li> <li>• Legs: solid beech</li> <li>• Glides: non-adjustable</li> <li>• Upholstery: multiple densities of laminated polyurethane foam and polyester fiber on seat and back with top stitch sewing detail</li> </ul>	1 Style number 2 Wood color number for legs ► See <i>Hardwood and Veneer Matrix</i> , page 210 3 Fabric or leather color number for upholstery on seat and back 4 Options, if selected (see below) ► See <i>Surface Materials</i> , page 196.

Options	Price	Required to Specify	
<b>Surface Materials</b>	<b>Acrylic backer</b>		
• Lounge chair	+\$ 55	Specify with acrylic backer. ► See <i>Surface Materials</i> , page 196.	
<b>Legs</b>			
• Brushed aluminum	+\$232	Specify with brushed aluminum legs. Specify with powder coat legs and select color: 4138 Graphite Gloss 4140 Arctic White Gloss 4142 Platinum Gloss 4144 Black Gloss 4148 Midnight Brown Gloss Specify with acrylic legs.	
• Powder coat	+\$186		
	• Acrylic: clear	+\$327	
<b>Casters</b>	• Ottoman casters	+\$202	Specify with casters.

Specification Information													
Style Number	Base Prices										Leather Grades:		
	Fabric Grades:										COL	C	E
	COM	6	7	8	9	10	11	12	13	14			

## Lounge Chair

470	\$2116	\$2116	\$2152	\$2220	\$2415	\$2544	\$2691	\$2797	\$2978	\$3234	\$2340	\$4986	\$5470
-----	--------	--------	--------	--------	--------	--------	--------	--------	--------	--------	--------	--------	--------

COM/yds = 4¼, COL/sq ft = 94

# Coupe Grande/Mobile

DESIGN DENNIE PIMENTAL / JOHN DUFFY

*Tip: Fabrics and leathers will appear loose with comfort wrinkles when upholstered.*

*Tip: Recommended leathers are Elmosoft Grade C and Elmorustical Grade E.*

*Tip: Special color match, consult Customer Service.*

*Tip: For Customer's Own Material or Leather, see necessary requirements, important processing instructions, and ordering information.*  
▶Page 198

Standard Includes		Required to Specify
▶Need help? Product details, see <i>Coalesse Seating and Outdoor Specification Guide</i>	<ul style="list-style-type: none"> <li>• Frame: unibody construction of hardwood plywood utilizing box joinery</li> <li>• Legs: solid beech</li> <li>• Glides: non-adjustable</li> <li>• Upholstery: multiple densities of laminated polyurethane foam and polyester fiber on seat and back with top stitch sewing detail</li> <li>• On 476M model:                             <ul style="list-style-type: none"> <li>- Casters: swivel hard</li> <li>- Locking and non-locking wheels</li> </ul> </li> <li>Tablet:                             <ul style="list-style-type: none"> <li>- Laminate</li> <li>- 13½" diameter</li> </ul> </li> </ul>	1 Style number 2 Wood color number for legs ▶See <i>Hardwood and Veneer Matrix</i> , page 210 3 Fabric or leather color number for seat and back 4 Laminate color number for 476M tablet, if selected 5 Options, if selected (see below) ▶See <i>Surface Materials</i> , page 196.

Options	Price	Required to Specify
<b>Surface Materials</b> • Acrylic backer • Lounge chair	+\$ 68	Specify with acrylic backer. ▶See <i>Surface Materials</i> , page 196.
<b>Casters (476M only)</b> <b>Legs</b> <ul style="list-style-type: none"> <li>• Soft casters</li> <li>• Brushed aluminum</li> <li>• Powder coat</li> </ul>	No cost +\$232 +\$186	Specify with soft casters. Specify with brushed aluminum legs. Specify with powder coat legs and select color: 4138 Graphite Gloss 4140 Arctic White Gloss 4142 Platinum Gloss 4144 Black Gloss 4148 Midnight Brown Gloss Specify with acrylic legs.
<b>Tablet (476M only)</b> • Acrylic: clear • Omit tablet	+\$327 -\$222	Specify with acrylic legs. Specify with remove tablet.

Specification Information													
Style Number	Base Prices												
	Fabric Grades:												
	COM	6	7	8	9	10	11	12	13	14	Leather Grades:		
											COL	C	E

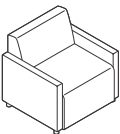

Overall: 28"D 31"W 30"H  
 Inside: 20"D 25"W 13"H  
 Seat: 17"H  
 Arm: 22"H

## Lounge Chair

476	\$2446	\$2474	\$2520	\$2597	\$2831	\$2979	\$3157	\$3279	\$3493	\$3795	\$2656	\$5796	\$6356
-----	--------	--------	--------	--------	--------	--------	--------	--------	--------	--------	--------	--------	--------

COM/yds = 5, COL/sq ft = 110

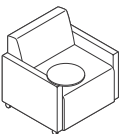

Overall: 28"D 31"W 30"H  
 Inside: 20"D 25"W 13"H  
 Seat: 17"H  
 Arm: 22"H

## Mobile Chair

476M	\$3142	\$3170	\$3216	\$3293	\$3527	\$3675	\$3853	\$3975	\$4189	\$4491	\$3352	\$6478	\$7047
------	--------	--------	--------	--------	--------	--------	--------	--------	--------	--------	--------	--------	--------

COM/yds = 5, COL/sq ft = 110



Coalesse SIN 33721

# Coupe Grande/Mobile

DESIGN DENNIE PIMENTAL / JOHN DUFFY

Lounge Seating

# Joel Lounge by Walter Knoll

DESIGN E00S



**Overall:** 29"D x 30 1/4"W x 27 1/2"H  
**Seat:** 16 1/4"H  
**Arm:** 26 1/4"H  
**Inside:** 21 1/2"D x 16 1/2"-23"W x 11"H

*Tip: Fabrics and leathers will appear loose with comfort wrinkles when upholstered.*

*Tip: For Customer's Own Material or Leather, see necessary requirements, important processing instructions, and ordering information.*

► Page 198

Standard Includes		Required to Specify
<ul style="list-style-type: none"> <li>► Need help? Product details, see <i>Coalesse Seating and Outdoor Specification Guide</i></li> </ul>	<ul style="list-style-type: none"> <li>• Base frame: steel with molded rigid foam</li> <li>• Seat frame: plywood with molded foam</li> <li>• Base: chrome plated steel</li> <li>• Auto swivel return mechanism</li> </ul>	<ol style="list-style-type: none"> <li>1 Style number</li> <li>2 Number of fabrics if contrasting fabric style number is selected</li> <li>3 Fabric or leather color number for upholstery</li> <li>4 Options, if selected (see below)</li> </ol> <p>► See <i>Surface Materials</i>, page 196.</p>

Options	Price	Required to Specify
<b>Surface Materials</b> <ul style="list-style-type: none"> <li>• Contrasting fabric</li> </ul>	+\$167 per fabric	Add suffix K to the style number and select fabric color number.
<b>Acrylic backer</b> <ul style="list-style-type: none"> <li>• Backer</li> </ul>	+\$ 46	Specify with <i>acrylic backer</i> . ► See <i>Surface Materials</i> , page 196.

Specification Information															
Style Number	Base Prices												Leather Grades:		
	Fabric Grades:												COL	C	E
	COM	6	7	8	9	10	11	12	13	14					
COWK100	\$2648	\$2648	\$2679	\$2734	\$2897	\$3001	\$3124	\$3209	\$3362	\$3569	\$2857	\$4896	\$5132		

COM/yds = 3 1/2, COL/sq ft = 77

# Joel Lounge Multi-Fabric Diagram

DESIGN EOOS

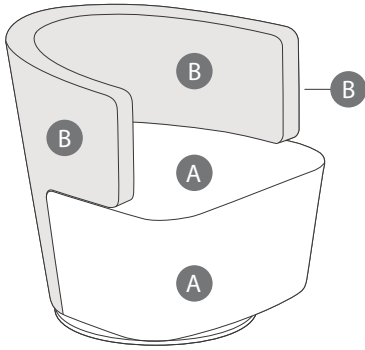

TO: \_\_\_\_\_

FROM: \_\_\_\_\_

DATE: \_\_\_\_\_

FAX...888.413.5161

**A** Seat (upholstery selections default for entire unit if B is not selected): \_\_\_\_\_

**B** Back: \_\_\_\_\_

*Contrasting upcharge for each contrasting textile pricing based on highest grade textile specified. See specifying for contrasting upcharge.*

# Ripple Benches

DESIGN LAURINDA SPEAR, FAIA

*Tip: Fabrics and leathers will appear loose with comfort wrinkles when upholstered.*

*Tip: Pricing based on highest grade textile specified.*

*Tip: Due to the design and construction techniques of Ripple lounge, only certain textiles can be successfully applied, therefore COM fabrics must be submitted to Coalesse for approval prior to order acceptance. Solid patterns with no repeat are recommended.*

*Tip: Recommended leathers are Elmosoft Grade C and Elmorustical Grade E.*

*Tip: Special color match, consult Customer Service.*

*Tip: For Customer's Own Material or Leather, see necessary requirements, important processing instructions, and ordering information.*

► Page 198

*Tip: 96" is a three-seat lounge.*

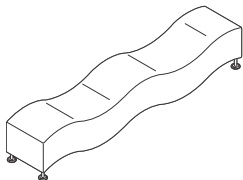

Overall: 19¼"D 97"W 19¼"H  
Dip: 14"H

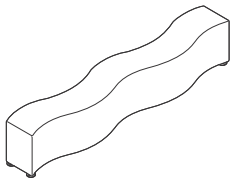

Overall: 19¼"D 97"W 19¼"H  
Seat Surface: 19"H

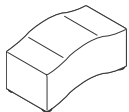

Overall: 19"D 35¾"W 19¼"H

Standard Includes		Required to Specify
► Need help? Product details, see <i>Coalesse Seating and Outdoor Specification Guide</i>	<ul style="list-style-type: none"> <li>• Frame: unibody construction with finger jointed plywood</li> <li>• Upholstery: multiple densities of laminated polyurethane foam</li> <li>• Glides: height adjustable with stainless steel finish leveling polyurethane glides</li> <li>• Double needle stitch seams</li> </ul>	1 Style number 2 Number of fabrics if contrasting fabric style number is selected 3 Fabric or leather color number for upholstery on bench 4 Options, if selected (see below) ► See <i>Surface Materials</i> , page 196.

Options	Price	Required to Specify
<b>Surface Materials</b>	<ul style="list-style-type: none"> <li>• Contrasting fabric +\$167 per fabric</li> </ul>	Add suffix K to the style number and select fabric color number.
	<b>Acrylic backer</b> <ul style="list-style-type: none"> <li>• Wave and flat seats +\$ 96</li> <li>• Little Ripple wave and flat seats +\$ 43</li> </ul>	Specify with <i>acrylic backer</i> . Specify with <i>acrylic backer</i> . ► See <i>Surface Materials</i> , page 196.

Specification Information													
Style Number	Base Prices											Leather Grades:	
	Fabric Grades:											COL	C
	COM	6	7	8	9	10	11	12	13	14			

## Upholstered Wave Seat

490-B96VRT	\$2893	\$3039	\$3107	\$3224	\$3574	\$3798	\$4062	\$4244	\$4566	\$5017	\$3134	\$7471	\$8252
COM/yds = 7½, COL/sq ft = 143													

## Upholstered Flat Seat

490-B96HRZ	\$2893	\$3039	\$3107	\$3224	\$3574	\$3798	\$4062	\$4244	\$4566	\$5017	\$3134	\$7471	\$8252
COM/yds = 7½, COL/sq ft = 143													

## Little Ripple Wave Seat

490-B35VRT	\$1219	\$1219	\$1240	\$1274	\$1378	\$1446	\$1526	\$1581	\$1680	\$1814	\$1550	\$3003	\$3268
COM/yds = 2¼, COL/sq ft = 50													

► Specification Information, continued on next page

# Ripple Benches

DESIGN LAURINDA SPEAR, FAIA

► Specification Information, continued from previous page

## Specification Information

Style Number	Base Prices											Leather Grades:		
	Fabric Grades:											COL	C	E
	COM	6	7	8	9	10	11	12	13	14				

### Little Ripple Flat Seat

<b>490-B35HRZ</b>	\$1219	\$1219	\$1240	\$1274	\$1378	\$1446	\$1526	\$1581	\$1680	\$1814	\$1550	\$3003	\$3268
COM/yds = 2¼, COL/sq ft = 50													

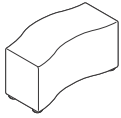

Overall: 19"D 35½"W 19"H

# Sidewalk Lounge/Mobile

DESIGN STUDIO B

*Tip: Fabrics and leathers will appear loose with comfort wrinkles when upholstered.*

*Tip: Recommended leathers are Elmosoft Grade C and Elmorustical Grade E.*

*Tip: Special color match, consult Customer Service.*

*Tip: Multi-fabric diagram available.*

► Page 72

*Tip: For Customer's Own Material or Leather, see necessary requirements, important processing instructions, and ordering information.*

► Page 198

*Tip: Specify tablet from facing position.*

*Tip: Tablet can be installed on mobile models only.*

*Tip: Cup holder must be specified with tablet.*

*Tip: Extra pivoter allows tablet to be moved side to side.*

Standard Includes		Required to Specify
► Need help? Product details, see <i>Coalesse Seating and Outdoor Specification Guide</i>	<ul style="list-style-type: none"> <li>• Frame: unibody construction with finger jointed plywood</li> <li>• Upholstery: multiple densities of polyurethane foam and polyester fiber on seat, back, and arms.</li> <li>• Lounge:                             <ul style="list-style-type: none"> <li>- Legs: silver powder coat steel legs with "go" glide</li> </ul> </li> <li>• Mobile:                             <ul style="list-style-type: none"> <li>- 13½" diameter tablet: laminate</li> <li>- Legs: Silver powder coat steel legs with casters</li> <li>- Casters: four non-locking</li> </ul> </li> </ul>	1 Style number 2 Number of fabrics if contrasting fabric style number is selected 3 Fabric or leather color number for upholstery on seat, back, and arms 4 Options, if selected (see below) ► See <i>Surface Materials</i> , page 196.

Options	Price	Required to Specify
<b>Surface Materials</b>	<ul style="list-style-type: none"> <li>• Contrasting fabric +\$167 per fabric</li> </ul>	Add suffix K to the style number and select fabric color number.
<b>Acrylic backer</b>		Specify with acrylic backer.
<ul style="list-style-type: none"> <li>• Lounge chair +\$ 50</li> <li>• Lounge two-seat chair +\$ 71</li> <li>• Arm bolster +\$ 9</li> </ul>		Specify with acrylic backer. Specify with acrylic backer. Specify with acrylic backer. ► See <i>Surface Materials</i> , page 196.
<b>Tablet Position</b>	<ul style="list-style-type: none"> <li>• Left-side facing No cost</li> <li>• Right-side facing No cost</li> </ul>	Specify with left-side facing. Specify with right-side facing.
<b>Cup Holder</b>	<ul style="list-style-type: none"> <li>• Cup holder +\$ 71</li> </ul>	Specify with cup holder.
<b>Tablet Side Storage</b>	<ul style="list-style-type: none"> <li>• Tablet side storage +\$105</li> </ul>	Specify with tablet side storage.
<b>Extra Pivoter</b>	<ul style="list-style-type: none"> <li>• Extra pivoter +\$245</li> </ul>	Specify with extra pivoter.
<b>Omit Tablet</b>	<ul style="list-style-type: none"> <li>• Omit tablet -\$214</li> </ul>	Specify with omit tablet.
<b>Glides</b>		
<ul style="list-style-type: none"> <li>• <b>Lounge</b></li> <li>• "No go" ½" polyethylene glide No cost</li> </ul>		Specify with "no go".
<ul style="list-style-type: none"> <li>• <b>Mobile</b></li> <li>• Go glides No cost</li> </ul>		Specify with go glides.
<b>Casters</b>	<ul style="list-style-type: none"> <li>• Locking casters No cost</li> </ul>	Specify with locking casters.
<b>Related Products</b>	<ul style="list-style-type: none"> <li>• Ottomans/benches</li> <li>• Sidewalk tables</li> </ul>	► Page 76 ► See <i>GSA Volume 5b Specification Guide</i> .

Specification Information													
Style Number	Base Prices											Leather Grades:	
	Fabric Grades:											COL	C
COM	6	7	8	9	10	11	12	13	14				

## Low-Back Lounge Chair

444	\$2161	\$2161	\$2196	\$2259	\$2446	\$2566	\$2705	\$2804	\$2972	\$3217	\$2427	\$5208	\$5667
-----	--------	--------	--------	--------	--------	--------	--------	--------	--------	--------	--------	--------	--------

COM/yds = 4, COL/sq ft = 88

► Specification Information, continued on next page

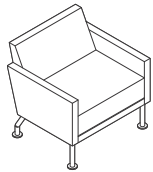

Overall: 27"D 30½"W 29"H  
 Inside: 19"D 26"W 17"H  
 Seat: 17½"H  
 Arm: 23"H

# Sidewalk Lounge/Mobile

DESIGN STUDIO B

► Specification Information, continued from previous page

## Specification Information

Style Number	Base Prices										Leather Grades:		
	Fabric Grades:										COL	C	E
	COM	6	7	8	9	10	11	12	13	14			

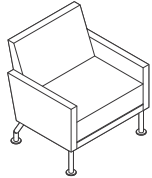

Overall: 27"D 30½"W 32"H  
 Inside: 19"D 26"W 20"H  
 Seat: 17½"H  
 Arm: 23"H

### High-Back Lounge Chair

446	\$2383	\$2390	\$2431	\$2499	\$2711	\$2844	\$3002	\$3112	\$3304	\$3574	\$2644	\$5616	\$6078
-----	--------	--------	--------	--------	--------	--------	--------	--------	--------	--------	--------	--------	--------

COM/yds = 4½, COL/sq ft = 99

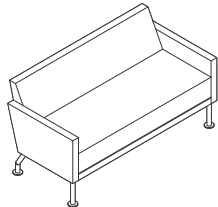

Overall: 27"D 56½"W 29"H  
 Inside: 19"D 52"W 17"H  
 Seat: 17½"H  
 Arm: 23"H

### 2-Seat Lounge

444-2	\$3367	\$3420	\$3472	\$3554	\$3811	\$3977	\$4169	\$4304	\$4540	\$4870	\$3628	\$7479	\$7995
-------	--------	--------	--------	--------	--------	--------	--------	--------	--------	--------	--------	--------	--------

COM/yds = 5½, COL/sq ft = 121

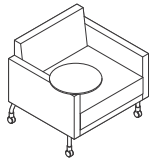

Overall: 27"D 30½"W 29"H  
 Inside: 19"D 26"W 17"H  
 Seat: 17½"H  
 Arm: 22½"H

### Low-Back Mobile Lounge Chair with Tablet

444M	\$2937	\$2937	\$2972	\$3035	\$3222	\$3342	\$3481	\$3580	\$3748	\$3993	\$3196	\$5977	\$6491
------	--------	--------	--------	--------	--------	--------	--------	--------	--------	--------	--------	--------	--------

COM/yds = 4, COL/sq ft = 88

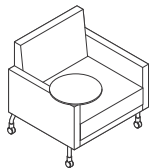

Overall: 27"D 30½"W 32"H  
 Inside: 19"D 26"W 20"H  
 Seat: 17½"H  
 Arm: 22½"H

### High-Back Mobile Lounge Chair with Tablet

446M	\$3164	\$3171	\$3212	\$3280	\$3492	\$3625	\$3783	\$3893	\$4085	\$4355	\$3412	\$6551	\$7117
------	--------	--------	--------	--------	--------	--------	--------	--------	--------	--------	--------	--------	--------

COM/yds = 4½, COL/sq ft = 99



Overall: 17½"H 5¾" Dia

### Arm Bolster

440-B	\$386	\$392	\$402	\$421	\$464	\$533	\$585	\$598	\$621	\$645	\$777	\$1180	\$1580
-------	-------	-------	-------	-------	-------	-------	-------	-------	-------	-------	-------	--------	--------

COM/yds = 1, COL/sq ft = 18

# Sidewalk Multi-Fabric Diagram

DESIGN STUDIO B

TO: \_\_\_\_\_

FROM: \_\_\_\_\_

DATE: \_\_\_\_\_

FAX....888.413.5161

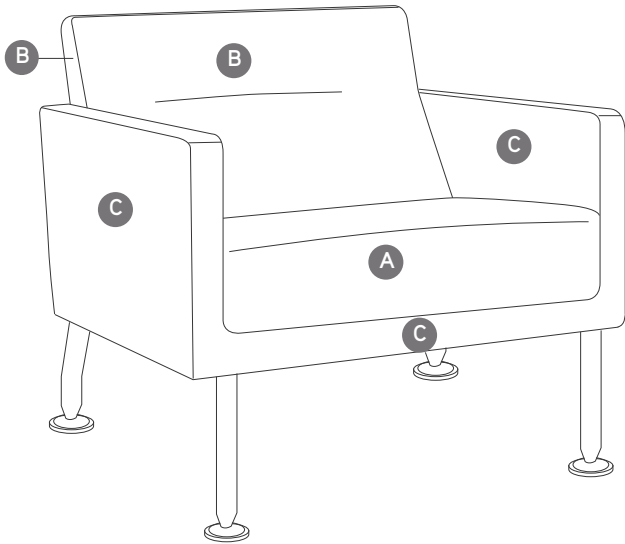

**A** Upholstery Selection (default for entire unit if B is not selected):

\_\_\_\_\_  
\_\_\_\_\_

**B** Back: \_\_\_\_\_

\_\_\_\_\_

**C** Arms: \_\_\_\_\_

\_\_\_\_\_

Total list price upcharge for contrasting fabrics: \$ \_\_\_\_\_

*See specifying for contrasting fabric upcharge. List price based on highest fabric grade usage.*

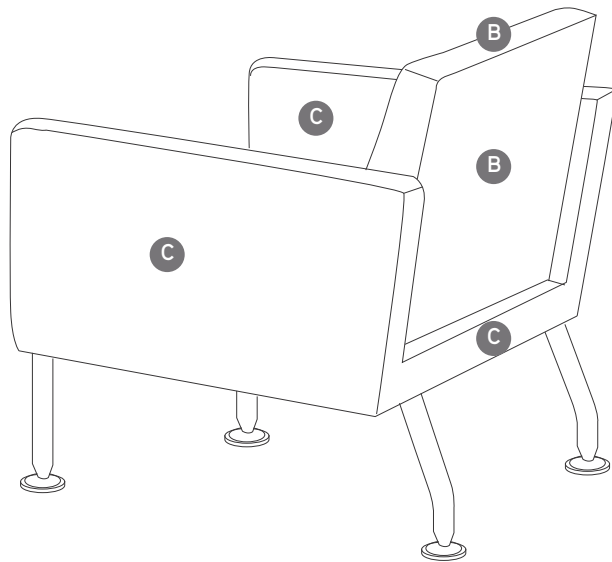

Specify Model below:

- 444K Sidewalk Low-Back Lounge Chair or Mobile
- 446K Sidewalk High-Back Lounge Chair or Mobile
- 444-2K Sidewalk 2-Seat Lounge



# Sidewalk

Multi-Fabric Diagram

DESIGN STUDIO B

# Sidewalk Collaborative

DESIGN STUDIO B

*Tip: Fabrics and leathers will appear loose with comfort wrinkles when upholstered.*

*Tip: Recommended leathers are Elmosoft Grade C and Elmorustical Grade E.*

*Tip: Special color match, consult Customer Service.*

*Tip: For Customer's Own Material or Leather, see necessary requirements, important processing instructions, and ordering information.*  
 ▶ Page 198

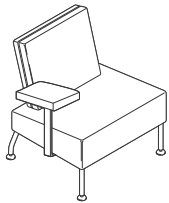

*Tip: Overall width dimensions with arm options: 430: 35"W 430-2: 49"W. Overall inside width dimensions with arm options: 430: 19 1/2"W 430-2: 49"W.*

▶ See Sidewalk multi-fabric diagram,  
 ▶ Page 77

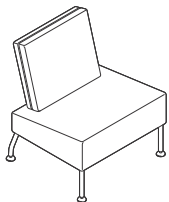

**Overall:** 27"D 27"W 30 1/2"H  
**Inside:** 17"D 27"W 18"H  
**Seat:** 17"H  
**Arm:** 21"H

Standard Includes		Required to Specify	
▶ Need help? Product details, see <i>Coalesse Seating and Outdoor Specification Guide</i>	<ul style="list-style-type: none"> <li>Frame: unibody construction with finger jointed plywood</li> <li>Upholstery: multiple densities of polyurethane foam and polyester fiber on seat and back</li> <li>Legs: silver powder coat steel with "go" glides</li> </ul>	<ol style="list-style-type: none"> <li>Style number</li> <li>Number of fabrics if contrasting fabric style number is selected</li> <li>Fabric or leather color number for upholstery on seat and back</li> <li>Options, if selected (see below)</li> </ol> ▶ See <i>Surface Materials</i> , page 196.	
Surface Materials	Options	Price	Required to Specify
	<ul style="list-style-type: none"> <li>Contrasting fabric</li> </ul>	+\$167 per fabric	Add suffix K to the style number and select fabric color number.
	<b>Acrylic backer</b> <ul style="list-style-type: none"> <li>Lounge chair</li> <li>2-seat chair</li> <li>17"D x 17"W and 17"D x 20"W ottomans</li> <li>20"D x 26"W Ottoman</li> </ul>	+\$ 30 +\$ 55 +\$ 18 +\$ 24	Specify with <i>acrylic backer</i> . Specify with <i>acrylic backer</i> . Specify with <i>acrylic backer</i> . ▶ See <i>Surface Materials</i> , page 196.
<b>Attachment Straps</b>	<ul style="list-style-type: none"> <li>Attachment straps available on 430 model</li> <li>Attachment straps available on 430-2 model</li> </ul>	+\$ 93 +\$185	Specify with <i>attachment straps</i> . Specify with <i>attachment straps</i> .
<b>Arms</b>	<ul style="list-style-type: none"> <li>Arms on 430 and 430-2 3/4 yard or 14 sq. ft. required for COM/COL</li> </ul>	+\$ 66 per arm	Specify with <i>arms</i> .
<b>Glides</b>	<ul style="list-style-type: none"> <li>"No go" 1/2" polyethylene glides</li> </ul>	No cost	Specify with <i>"no go" glides</i> .

## Specification Information

Style Number	Base Prices														Leather Grades:		
	Fabric Grades:														COL	C	E
	COM	6	7	8	9	10	11	12	13	14							

## Lounge Chair

430	\$2026	\$2026	\$2050	\$2095	\$2222	\$2305	\$2401	\$2468	\$2589	\$2754	\$2352	\$4052	\$4493
-----	--------	--------	--------	--------	--------	--------	--------	--------	--------	--------	--------	--------	--------

COM/yds = 2 3/4, COL/sq ft = 77

▶ Specification Information, continued on next page

► Specification Information, continued from previous page

Specification Information

Style Number	Base Prices											Leather Grades:		
	Fabric Grades:											COL	C	E
	COM	6	7	8	9	10	11	12	13	14				

2-Seat Lounge

430-2	\$3014	\$3014	\$3050	\$3118	\$3313	\$3442	\$3589	\$3695	\$3876	\$4132	\$3279	\$5831	\$6328
-------	--------	--------	--------	--------	--------	--------	--------	--------	--------	--------	--------	--------	--------

COM/yds = 4¼, COL/sq ft = 115

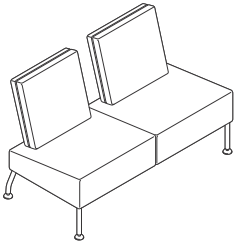

Overall: 27"D 49"W 30½"H  
 Inside: 17"D 49"W 18"H  
 Seat: 17"H  
 Arm: 21"H

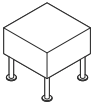

Overall: 17"D 17"W 17"H

Ottoman

430-H1717	\$1234	\$1234	\$1248	\$1270	\$1342	\$1385	\$1439	\$1476	\$1538	\$1628	\$1630	\$2103	\$2446
-----------	--------	--------	--------	--------	--------	--------	--------	--------	--------	--------	--------	--------	--------

COM/yds = 1½, COL/sq ft = 22½

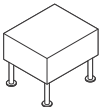

Overall: 17"D 20"W 17"H

430-H1720	\$1234	\$1234	\$1248	\$1270	\$1342	\$1385	\$1439	\$1476	\$1538	\$1628	\$1630	\$2103	\$2446
-----------	--------	--------	--------	--------	--------	--------	--------	--------	--------	--------	--------	--------	--------

COM/yds = 1½, COL/sq ft = 24

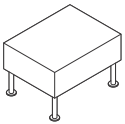

Overall: 20"D 26"W 17"H

430-H2026	\$1476	\$1476	\$1495	\$1523	\$1617	\$1678	\$1749	\$1797	\$1882	\$2002	\$1828	\$2587	\$2938
-----------	--------	--------	--------	--------	--------	--------	--------	--------	--------	--------	--------	--------	--------

COM/yds = 2, COL/sq ft = 36

# Sidewalk Ottoman/Benches

DESIGN STUDIO B

*Tip: Fabrics and leathers will appear loose with comfort wrinkles when upholstered.*

*Tip: Recommended leathers are Elmosoft Grade C and Elmorustical Grade E.*

*Tip: Special color match, consult Customer Service.*

*Tip: For Customer's Own Material or Leather, see necessary requirements, important processing instructions, and ordering information.*  
▶ Page 198

Standard Includes		Required to Specify	
▶ Need help? Product details, see <i>Coalesse Seating and Outdoor Specification Guide</i>	<ul style="list-style-type: none"> <li>• Frame: unibody construction with finger jointed plywood.</li> <li>• Upholstery: multiple densities of polyurethane foam and polyester fiber on ottoman/benches</li> <li>• Legs: silver powder coat steel with "go" glides</li> </ul>	1 Style number 2 Fabric or leather color number for upholstery on ottoman/benches 3 Options, if selected (see below) ▶ See <i>Surface Materials</i> , page 196.	
Options		Price	Required to Specify
<b>Surface Materials</b>	<b>Acrylic backer</b>		
	• 17"D x 24"W bench	+\$18	Specify with acrylic backer.
	• 17"D x 36"W bench	+\$24	Specify with acrylic backer.
	• 17"D x 48"W bench	+\$30	Specify with acrylic backer.
	• Ottoman	+\$43	Specify with acrylic backer. ▶ See <i>Surface Materials</i> , page 196.
<b>Glides</b>	• "No go" 1/2" polyethylene glides	No cost	Specify with "no go" glides.

## Specification Information

Style Number	Base Prices										Leather Grades:		
	Fabric Grades:	6	7	8	9	10	11	12	13	14	COL	C	E

### Benches

<b>430-B1724</b>	\$1338	\$1338	\$1352	\$1374	\$1446	\$1489	\$1543	\$1580	\$1642	\$1732	\$1732	\$2282	\$2607
------------------	--------	--------	--------	--------	--------	--------	--------	--------	--------	--------	--------	--------	--------

COM/yds = 1½, COL/sq ft = 27

<b>430-B1736</b>	\$1572	\$1572	\$1591	\$1619	\$1713	\$1774	\$1845	\$1893	\$1978	\$2098	\$1934	\$2694	\$3060
------------------	--------	--------	--------	--------	--------	--------	--------	--------	--------	--------	--------	--------	--------

COM/yds = 2, COL/sq ft = 36

<b>430-B1748</b>	\$1813	\$1813	\$1834	\$1874	\$1990	\$2065	\$2150	\$2213	\$2321	\$2469	\$2141	\$3109	\$3474
------------------	--------	--------	--------	--------	--------	--------	--------	--------	--------	--------	--------	--------	--------

COM/yds = 2½, COL/sq ft = 45

### Ottoman

<b>430-H3636</b>	\$1833	\$1833	\$1857	\$1902	\$2029	\$2112	\$2208	\$2275	\$2396	\$2561	\$2152	\$4068	\$4477
------------------	--------	--------	--------	--------	--------	--------	--------	--------	--------	--------	--------	--------	--------

COM/yds = 2¾, COL/sq ft = 61

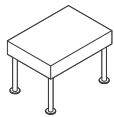

Overall: 17"D 24"W 17"H

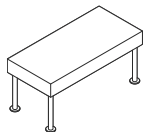

Overall: 17"D 36"W 17"H

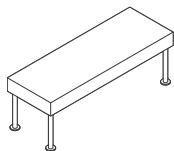

Overall: 17"D 48"W 17"H

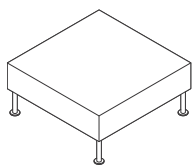

Overall: 36"D 36"W 17"H

# Sidewalk Collaborative Multi-Fabric Diagram

DESIGN STUDIO B

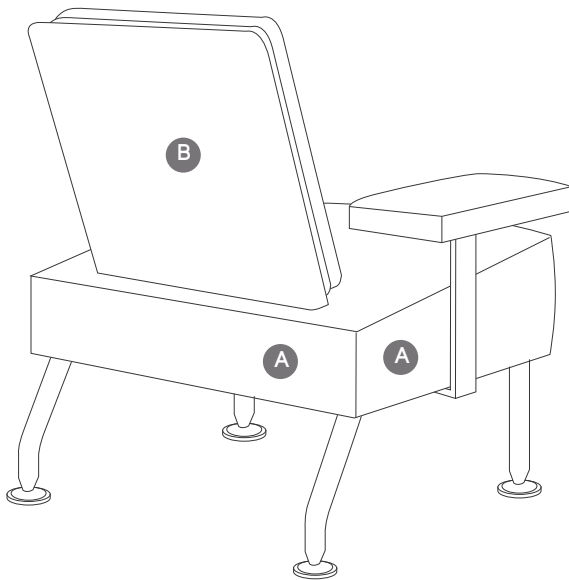
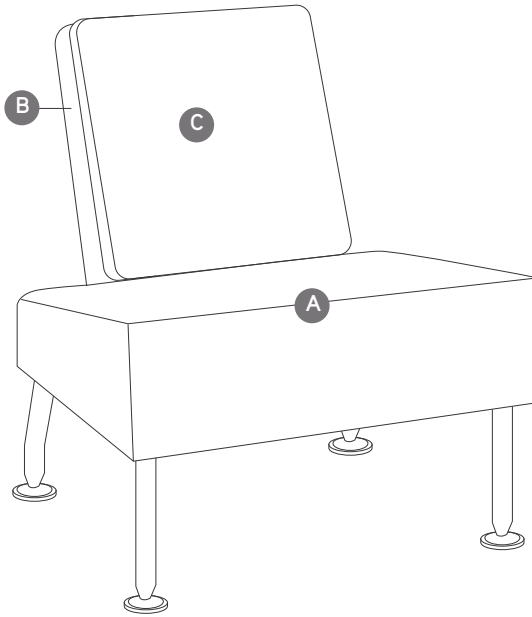

TO: \_\_\_\_\_

FROM: \_\_\_\_\_

DATE: \_\_\_\_\_

FAX....888.413.5161

**A** Upholstery Selection (default for entire unit if B is not selected): \_\_\_\_\_

**B** Back: \_\_\_\_\_

**C** Back Cushion: \_\_\_\_\_

Total list price upcharge for contrasting fabrics: \$ \_\_\_\_\_

*See specifying for contrasting fabric upcharge. List price based on highest fabric grade usage.*

# Davos by Viccarbe

DESIGN JEFFREY BERNETT

*Tip: For Customer's Own Material or Leather, see necessary requirements, important processing instructions, and ordering information.*  
 ▶ Page 198

*Tip: Fabrics and leathers will appear loose with comfort wrinkles when upholstered.*

*Tip: K suffix must be specified for leather underside.*

*Tip: Models with fabric underside include black denim section to allow for proper air flow. If this aesthetic is not desired, select contrasting option with leather underside.*

Standard Includes		Required to Specify
▶ Need help? Product details, see <i>Coalesse Seating and Outdoor Specification Guide</i>	<ul style="list-style-type: none"> <li>Upholstery for chair or bench: fabric or leather</li> <li>Glides: non-adjustable metal</li> </ul>	1 Style number 2 Number of fabrics if contrasting fabric style number is selected 3 Fabric or leather color number for upholstery 4 Options, if selected (see below) ▶ See <i>Surface Materials</i> , page 196.

Options	Price	Required to Specify
<b>Surface Materials</b>	• Contrasting fabric	+ \$167 per fabric
	<b>Acrylic backer</b>	
	• Chair	+ \$ 77
	• Large bench	+ \$ 46
	• Medium bench	+ \$ 36
	• Small bench	+ \$ 22
		Add suffix K to the style number and select fabric color number.  Specify with <i>acrylic backer</i> . Specify with <i>acrylic backer</i> . Specify with <i>acrylic backer</i> . Specify with <i>acrylic backer</i> . ▶ See <i>Surface Materials</i> , page 196.

Specification Information														
Style Number	Base Prices											Leather Grades:		
	Fabric Grades:											COL	C	E
	COM	6	7	8	9	10	11	12	13	14				

## Lounge Chair

CODAV	\$2913	\$2941	\$2987	\$3064	\$3298	\$3446	\$3624	\$3746	\$3960	\$4262	\$3082	\$5444	\$5846
COM/yds = 5, COL/sq ft = 110													

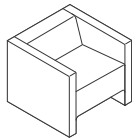

Overall: 30"D 30"W 25½"H  
 Seat: 19"D 24"W 16½"H

## Large Bench

CODAV60	\$2394	\$2394	\$2426	\$2475	\$2628	\$2723	\$2837	\$2917	\$3059	\$3254	\$2618	\$3985	\$4209
COM/yds = 3¼, COL/sq ft = 71½													

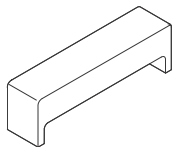

Overall: 13¼"D 59½"W 17½"H

## Medium Bench

CODAV38	\$1721	\$1721	\$1742	\$1782	\$1898	\$1973	\$2058	\$2121	\$2229	\$2377	\$1977	\$3200	\$3401
COM/yds = 2½, COL/sq ft = 55													

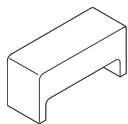

Overall: 13¼"D 38"W 17½"H

## Small Bench

CODAV16	\$1104	\$1104	\$1118	\$1145	\$1226	\$1279	\$1340	\$1383	\$1460	\$1564	\$1395	\$2335	\$2512
COM/yds = 1¾, COL/sq ft = 39													



Overall: 13¼"D 18½"W 17½"H

Coalesse SIN 33721

# Davos by Viccarbe

DESIGN JEFFREY BERNETT

Lounge Seating

# Hosu

DESIGN PATRICIA URQUIOLA

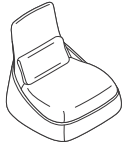

*Tip: Fabrics and leathers will appear loose with comfort wrinkles when upholstered.*

*Tip: Recommended leathers are Elmosoft Grade C and Elmorustical Grade E.*

*Tip: Frame design allows back to flex to support occupants back shape.*

*Tip: Due to the design and construction techniques of the Hosu lounge only certain textiles can be successfully applied, therefore all COM fabrics must be submitted to Coalesse for approval prior to order acceptance.*

*Tip: Hexa fabrics (fabric group 10) were specifically designed by Patricia Urquiola for Hosu lounge seating.*

► See *Coalesse Surface Materials Reference Guide* for complete listing of Hexa fabrics.

Standard Includes	Required to Specify
<p>► Need help? Product details, see <i>Coalesse Seating and Outdoor Specification Guide</i></p> <ul style="list-style-type: none"> <li>• Frame: plywood tab construction</li> <li>• Multiple densities of polyurethane foam and polyester fiber</li> <li>• Seat and back: fabric or leather</li> <li>• Wrap: made from ABS plastic</li> <li>• Footrest on fabric chair, if selected: Fusion fabric or leather</li> <li>• Footrest on leather chair, if selected: Fashion fabric or leather to match seat and back</li> <li>• Glides: non-adjustable</li> <li>• Pull tab on ottoman, if selected: Nylon strap</li> <li>• Grommet for wire pass-through on models COURQLO and COURQLOK, if selected</li> <li>• Pillow: fabric or leather</li> </ul>	<ol style="list-style-type: none"> <li>1 Style number</li> <li>2 Number of fabrics if contrasting fabric style number is selected</li> <li>3 Fabric or leather color number for upholstery on seat, back, and pillow</li> <li>4 Fusion color number for footrest, if selected: CL60 Caviar CL62 Graphite CL80 Terracotta CL81 Copper CL82 Sage CL83 Blue Ink CL84 Blue Steel</li> <li>5 Color number for pull tab with ottoman, if selected: CL40 Red CL41 Blue CL42 Black</li> <li>6 Options, if selected (see below) ► See <i>Surface Materials</i>, page 196.</li> </ol>

Options	Price	Required to Specify
<p><b>Surface Materials</b></p> <p><b>Pillow for lounge chair and lounge chair with ottoman</b></p> <ul style="list-style-type: none"> <li>• Fabric groups 6-10 No cost</li> <li>• Fabric group 11 +\$ 199</li> <li>• Fabric group 12 +\$ 225</li> <li>• Fabric group 13 +\$ 274</li> <li>• Fabric group 14 +\$ 338</li> <li>• Fabric group C +\$ 475</li> <li>• Fabric group E +\$ 572</li> <li>• Customer's Own Material (COM) +\$ 55</li> <li>• Customer's Own Leather (COL) +\$ 375</li> </ul> <hr/> <p><b>Pillows for two-seat lounge</b></p> <ul style="list-style-type: none"> <li>• Fabric groups 6-10 No cost</li> <li>• Fabric group 11 +\$ 348</li> <li>• Fabric group 12 +\$ 394</li> <li>• Fabric group 13 +\$ 476</li> <li>• Fabric group 14 +\$ 591</li> <li>• Fabric group C +\$ 842</li> <li>• Fabric group E +\$1017</li> <li>• Customer's Own Material (COM) +\$ 55</li> <li>• Customer's Own Leather (COL) +\$ 375</li> </ul> <hr/> <ul style="list-style-type: none"> <li>• Contrasting fabric +\$ 167 per fabric</li> </ul> <hr/> <p><b>Acrylic backer</b></p> <ul style="list-style-type: none"> <li>• Lounge chair +\$ 55</li> <li>• Lounge chair with ottoman +\$ 77</li> <li>• 2-seat lounge +\$ 103</li> </ul>		<p>Specify fabric color number. Specify fabric color number. Specify fabric color number. Specify fabric color number. Specify fabric color number. Specify fabric color number. ► See <i>Surface Materials</i>, page 196. ► See <i>Surface Materials</i>, page 196.</p> <hr/> <p>Specify fabric color number. Specify fabric color number. Specify fabric color number. Specify fabric color number. Specify fabric color number. Specify fabric color number. ► See <i>Surface Materials</i>, page 196. ► See <i>Surface Materials</i>, page 196.</p> <hr/> <p>Add suffix K to the style number and select fabric color number.</p> <hr/> <p>Specify with acrylic backer. Specify with acrylic backer. Specify with acrylic backer. ► See <i>Surface Materials</i>, page 196.</p>



# Hosu

DESIGN PATRICIA URQUIOLA

## Specification Information

Style Number	Base Prices										Leather Grades:		
	Fabric Grades:										COL	C	E
	COM	6	7	8	9	10	11	12	13	14			

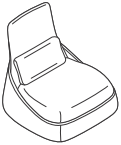

Overall: 35<sup>3</sup>/<sub>8</sub>"D 34<sup>3</sup>/<sub>8</sub>"W 35"H  
 Inside: 24"D 31"W 14"H  
 Pillow: 3"D 20<sup>1</sup>/<sub>16</sub>"W 10<sup>1</sup>/<sub>8</sub>"H

### Lounge Chair with Lumbar Pillow

<b>COURQL</b>	\$2992	\$3036	\$3080	\$3160	\$3406	\$3562	\$3749	\$3875	\$4102	\$4418	\$3161	\$4972	\$5201
---------------	--------	--------	--------	--------	--------	--------	--------	--------	--------	--------	--------	--------	--------

Lounge: COM/yds = 4<sup>1</sup>/<sub>4</sub>, COL/sq ft = 94  
 Pillow: COM/yds = 1, COL/sq ft = 22

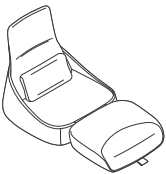

Overall: 35<sup>3</sup>/<sub>8</sub>"D 34<sup>3</sup>/<sub>8</sub>"W 35"H  
 Overall extended: 57"L  
 Inside: 24"D 31"W 14"H  
 Inside extended: 48"L  
 Pillow: 3"D 20<sup>1</sup>/<sub>16</sub>"W 10<sup>1</sup>/<sub>8</sub>"H  
 Ottoman: 24"D 31"W 8<sup>1</sup>/<sub>2</sub>"H

### Lounge Chair with Ottoman and Lumbar Pillow

<b>COURQLO</b>	\$3549	\$3660	\$3722	\$3823	\$4140	\$4340	\$4580	\$4743	\$5036	\$5440	\$3718	\$6271	\$6579
----------------	--------	--------	--------	--------	--------	--------	--------	--------	--------	--------	--------	--------	--------

Lounge: COM/yds = 5<sup>3</sup>/<sub>4</sub>, COL/sq ft = 126  
 Pillow: COM/yds = 1, COL/sq ft = 22

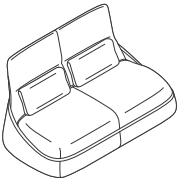

Overall: 35<sup>3</sup>/<sub>8</sub>"D 64<sup>1</sup>/<sub>8</sub>"W 35"H  
 Inside: 24"D 57<sup>1</sup>/<sub>8</sub>"W 14"H  
 Pillows: 3"D 24"W 10<sup>1</sup>/<sub>8</sub>"H

### 2-Seat Lounge with Two Lumbar Pillows

<b>COURQS</b>	\$4663	\$4857	\$4933	\$5065	\$5457	\$5716	\$6014	\$6220	\$6589	\$7099	\$4832	\$7780	\$8130
---------------	--------	--------	--------	--------	--------	--------	--------	--------	--------	--------	--------	--------	--------

Lounge: COM/yds = 6<sup>3</sup>/<sub>4</sub>, COL/sq ft = 143  
 Pillows: COM/yds = 1<sup>3</sup>/<sub>4</sub>, COL/sq ft = 39

# Millbrae Lounge

DESIGN COALESSE DESIGN GROUP

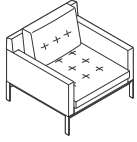

*Tip: Fabrics and leathers will appear loose with comfort wrinkles when upholstered.*

*Tip: For Customer's Own Material or Leather, see necessary requirements, important processing instructions, and ordering information.*

► Page 198

Standard Includes		Required to Specify	
<p>► Need help? Product details, see <i>Coalesse Seating and Outdoor Specification Guide</i></p> <ul style="list-style-type: none"> <li>• Frame: constructed with finger jointed plywood</li> <li>• Multiple densities of polyurethane foams and polyester fiber on seat and back: fabric or leather</li> <li>• The lifestyle collection has tufted pattern accents and separate back cushions with double needle top stitch: fabric or leather</li> <li>• The contract collection has quilted pattern accents with double needle top stitch: fabric or leather</li> <li>• Steel base: paint</li> <li>• Ganging kit with attachment hardware, if selected</li> </ul>		<p>1 Style number</p> <p>2 Fabric or leather color number for seat, back, and arms</p> <p>3 Paint color number for base</p> <p>4 Options, if selected (see below)</p> <p>► See <i>Surface Materials</i>, page 196.</p>	
Options		Price	Required to Specify
<b>Surface Materials</b>	<ul style="list-style-type: none"> <li>• Contrasting fabric</li> </ul>	+\$ 167 per fabric	<p>Add suffix K to the style number and select fabric color number.</p> <p>► See <i>Surface Materials</i>, page 196</p>
<b>Acrylic backer lifestyle chairs</b>			
	<ul style="list-style-type: none"> <li>• Lounge chair</li> <li>• 2-seat lounge</li> <li>• 3-seat lounge</li> </ul>	<p>+\$ 79</p> <p>+\$ 133</p> <p>+\$ 181</p>	<p>Specify with acrylic backer.</p> <p>Specify with acrylic backer.</p> <p>Specify with acrylic backer.</p>
<b>Acrylic backer contract chairs</b>			
	<ul style="list-style-type: none"> <li>• Lounge chair armless</li> <li>• Lounge chair with arms</li> <li>• Lounge chair left or right arm facing</li> <li>• 2-seat lounge armless</li> <li>• 2-seat lounge with arms</li> <li>• 2-seat lounge left or right arm facing</li> <li>• 3-seat lounge armless</li> <li>• 3-seat lounge with arms</li> <li>• 3-seat lounge left or right arm facing</li> <li>• Four-seat lounge armless</li> <li>• Four-seat lounge with arms</li> <li>• Four-seat lounge left or right arm facing</li> <li>• Bench</li> <li>• 2-seat bench</li> <li>• 3-seat bench</li> <li>• Four-seat bench</li> </ul>	<p>+\$ 30</p> <p>+\$ 50</p> <p>+\$ 45</p> <p>+\$ 50</p> <p>+\$ 71</p> <p>+\$ 64</p> <p>+\$ 71</p> <p>+\$ 90</p> <p>+\$ 79</p> <p>+\$ 90</p> <p>+\$ 109</p> <p>+\$ 97</p> <p>+\$ 22</p> <p>+\$ 30</p> <p>+\$ 45</p> <p>+\$ 50</p>	<p>Specify with acrylic backer.</p> <p>Specify with acrylic backer.</p> <p>Specify with acrylic backer.</p> <p>Specify with acrylic backer.</p> <p>Specify with acrylic backer.</p> <p>Specify with acrylic backer.</p> <p>Specify with acrylic backer.</p> <p>Specify with acrylic backer.</p> <p>Specify with acrylic backer.</p> <p>Specify with acrylic backer.</p> <p>Specify with acrylic backer.</p> <p>Specify with acrylic backer.</p> <p>Specify with acrylic backer.</p> <p>Specify with acrylic backer.</p>
<b>Bolsters</b>			
	<ul style="list-style-type: none"> <li>• Square or round bolster pillows</li> </ul>	+\$ 9	<p>Specify with acrylic backer.</p> <p>► See <i>Surface Materials</i>, page 196.</p>
<b>Base</b>			
	<ul style="list-style-type: none"> <li>• Grade 3 paint</li> </ul>	+\$ 133	Specify paint color number.
<b>Plated metal</b>			
	<ul style="list-style-type: none"> <li>• Lounge chair</li> <li>• 2-seat lounge</li> <li>• 3-seat lounge</li> <li>• Four-seat lounge</li> <li>• One-seat bench</li> <li>• 2-seat bench</li> <li>• 3-seat bench</li> <li>• Four-seat bench</li> </ul>	<p>+\$1075</p> <p>+\$1218</p> <p>+\$1793</p> <p>+\$1943</p> <p>+\$1075</p> <p>+\$1218</p> <p>+\$1793</p> <p>+\$1943</p>	<p>Specify with 9238 Brushed Nickel base.</p> <p>Specify with 9238 Brushed Nickel base.</p> <p>Specify with 9238 Brushed Nickel base.</p> <p>Specify with 9238 Brushed Nickel base.</p> <p>Specify with 9238 Brushed Nickel base.</p> <p>Specify with 9238 Brushed Nickel base.</p> <p>Specify with 9238 Brushed Nickel base.</p> <p>Specify with 9238 Brushed Nickel base.</p>
<b>Bolster/Pillow Attachment Rings</b>	<ul style="list-style-type: none"> <li>• Attachment rings for bolster/pillow attach to lounge attachment straps</li> </ul>	+\$ 90	Specify with attachment rings.
<b>Lounge Attachment Straps</b>	<ul style="list-style-type: none"> <li>• Attachment straps for lounge attach to bolster/pillow attachment rings</li> </ul>	No cost	Specify with attachment straps for left and right sides.
<b>Related Products</b>	<ul style="list-style-type: none"> <li>• Occasional tables</li> </ul>		► See <i>GSA Volume 5b Specification Guide</i> .

*Tip: Attachment straps are standard on back cushions of Lifestyle lounge.*

# Millbrae Lounge

DESIGN COALESSE DESIGN GROUP

## Specification Information

Style Number	Base Prices													
	Fabric Grades:													
	COM	6	7	8	9	10	11	12	13	14	Leather Grades:			
												COL	C	E

## Lifestyle Lounge Seating

### Lounge

COMSL1	\$3435	\$3479	\$3523	\$3603	\$3849	\$4005	\$4192	\$4318	\$4545	\$4861	\$3604	\$ 5948	\$ 6236
--------	--------	--------	--------	--------	--------	--------	--------	--------	--------	--------	--------	---------	---------

COM/yds = 5¼, COL/sq ft = 115

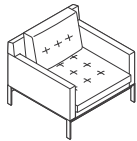

Overall: 35"D 35"W 28¾"H  
Overall inside: 29"D 29"W 17"H  
Inside to pillow: 22"D 29"W 17"H

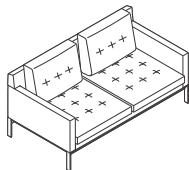

Overall: 35"D 64"W 28¾"H  
Overall inside: 29"D 58"W 17"H  
Inside to pillow: 22"D 58"W 17"H

### 2-Seat Lounge

COMSL2	\$5092	\$5276	\$5348	\$5475	\$5860	\$6107	\$6397	\$6598	\$6956	\$7451	\$5261	\$ 9167	\$ 9621
--------	--------	--------	--------	--------	--------	--------	--------	--------	--------	--------	--------	---------	---------

COM/yds = 8¼, COL/sq ft = 181

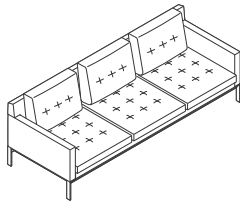

Overall: 35"D 92½"W 28¾"H  
Overall inside: 29"D 87"W 17"H  
Inside to pillow: 22"D 87"W 17"H

### 3-Seat Lounge

COMSL3	\$6313	\$6603	\$6696	\$6859	\$7349	\$7664	\$8032	\$8287	\$8739	\$9367	\$6482	\$11,569	\$12,147
--------	--------	--------	--------	--------	--------	--------	--------	--------	--------	--------	--------	----------	----------

COM/yds = 10½, COL/sq ft = 231

## Contract Lounge Chairs

### Without Arms

COMFL1	\$2894	\$2894	\$2918	\$2963	\$3090	\$3173	\$3269	\$3336	\$3457	\$3622	\$3141	\$ 4068	\$ 4204
--------	--------	--------	--------	--------	--------	--------	--------	--------	--------	--------	--------	---------	---------

COM/yds = 2¾, COL/sq ft = 60

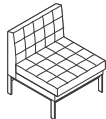

Overall: 30"D 26"W 31"H  
Inside seat height: 22"D 17"H

### With Arms

COMFLA1	\$3299	\$3299	\$3334	\$3397	\$3584	\$3704	\$3843	\$3942	\$4110	\$4355	\$3486	\$ 5192	\$ 5413
---------	--------	--------	--------	--------	--------	--------	--------	--------	--------	--------	--------	---------	---------

COM/yds = 4, COL/sq ft = 88

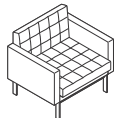

Overall: 30"D 32"W 31"H  
Inside: 22"D 26½"W 17"H

### With Left Arm Facing

COMFLLA1	\$3090	\$3090	\$3122	\$3171	\$3324	\$3419	\$3533	\$3613	\$3755	\$3950	\$3314	\$ 4641	\$ 4820
----------	--------	--------	--------	--------	--------	--------	--------	--------	--------	--------	--------	---------	---------

COM/yds = 3¼, COL/sq ft = 72



Overall: 30"D 29"W 31"H  
Inside: 22"D 26½"W 17"H

### With Right Arm Facing

COMFLRA1	\$3090	\$3090	\$3122	\$3171	\$3324	\$3419	\$3533	\$3613	\$3755	\$3950	\$3314	\$ 4641	\$ 4820
----------	--------	--------	--------	--------	--------	--------	--------	--------	--------	--------	--------	---------	---------

COM/yds = 3¼, COL/sq ft = 72

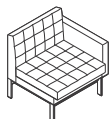

Overall: 30"D 29"W 31"H  
Inside: 22"D 26½"W 17"H

► Specification Information, continued on next page

# Millbrae Lounge *continued*

DESIGN COALESSE DESIGN GROUP

► Specification Information, continued from previous page

## Specification Information

Style Number	Base Prices										Leather Grades:		
	Fabric Grades:										COL	C	E
	COM	6	7	8	9	10	11	12	13	14			

### Contract 2-Seat Lounges

#### Without Arms

COMFL2	\$4616	\$4623	\$4664	\$4732	\$4944	\$5077	\$5235	\$5345	\$5537	\$5807	\$4785	\$6491	\$6712
--------	--------	--------	--------	--------	--------	--------	--------	--------	--------	--------	--------	--------	--------

COM/yds = 4½, COL/sq ft = 99

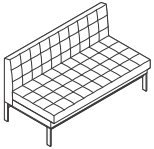

Overall: 30"D 52"W 31"H  
Inside seat height: 22"D 17"H

#### With Arms

COMFLA2	\$4959	\$5022	\$5076	\$5163	\$5430	\$5605	\$5808	\$5946	\$6192	\$6539	\$5128	\$7615	\$7918
---------	--------	--------	--------	--------	--------	--------	--------	--------	--------	--------	--------	--------	--------

COM/yds = 5¾, COL/sq ft = 126

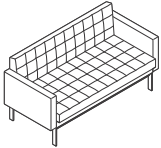

Overall: 30"D 58"W 31"H  
Inside: 22"D 52½"W 17"H

#### With Left Arm Facing

COMFLLA2	\$4787	\$4815	\$4861	\$4938	\$5172	\$5320	\$5498	\$5620	\$5834	\$6136	\$4956	\$7042	\$7300
----------	--------	--------	--------	--------	--------	--------	--------	--------	--------	--------	--------	--------	--------

COM/yds = 5, COL/sq ft = 110

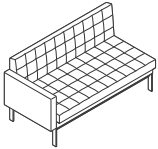

Overall: 30"D 55"W 31"H  
Inside: 22"D 52¾"W 17"H

#### With Right Arm Facing

COMFLRA2	\$4787	\$4815	\$4861	\$4938	\$5172	\$5320	\$5498	\$5620	\$5834	\$6136	\$4956	\$7042	\$7300
----------	--------	--------	--------	--------	--------	--------	--------	--------	--------	--------	--------	--------	--------

COM/yds = 5, COL/sq ft = 110

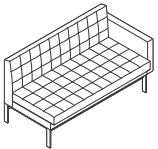

Overall: 30"D 55"W 31"H  
Inside: 22"D 52¾"W 17"H

► Specification Information, continued on next page

# Millbrae Lounge

DESIGN COALESSE DESIGN GROUP

► Specification Information, continued from previous page

## Specification Information

Style Number	Base Prices														Leather Grades:		
	Fabric Grades:														COL	C	E
	COM	6	7	8	9	10	11	12	13	14							

### Contract 3-Seat Lounges

#### Without Arms

<b>COMFL3</b>	\$5734	\$5810	\$5865	\$5956	\$6238	\$6417	\$6627	\$6773	\$7033	\$7392	\$5903	\$8390	\$8693
COM/yds = 6, COL/sq ft = 132													

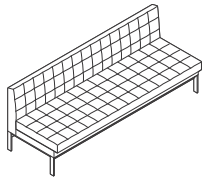

Overall: 30"D 78"W 31"H  
Inside seat height: 22"D 17"H

#### With Arms

<b>COMFLA3</b>	\$6082	\$6228	\$6296	\$6413	\$6763	\$6987	\$7251	\$7433	\$7755	\$8206	\$6251	\$9519	\$9904
COM/yds = 7½, COL/sq ft = 159													

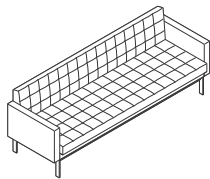

Overall: 30"D 84"W 31"H  
Inside: 22"D 78½"W 17"H

#### With Left Arm Facing

<b>COMFLLA3</b>	\$5909	\$6020	\$6082	\$6183	\$6500	\$6700	\$6940	\$7103	\$7396	\$7800	\$6078	\$8967	\$9311
COM/yds = 6¾, COL/sq ft = 148													

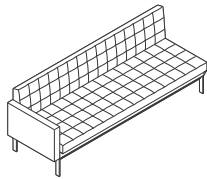

Overall: 30"D 81"W 31"H  
Inside: 22"D 78¾"W 17"H

#### With Right Arm Facing

<b>COMFLRA3</b>	\$5909	\$6020	\$6082	\$6183	\$6500	\$6700	\$6940	\$7103	\$7396	\$7800	\$6078	\$8967	\$9311
COM/yds = 6¾, COL/sq ft = 148													

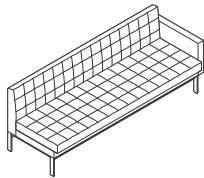

Overall: 30"D 81"W 31"H  
Inside: 22"D 78¾"W 17"H

► Specification Information, continued on next page

# Millbrae Lounge *continued*

DESIGN COALESSE DESIGN GROUP

► Specification Information, continued from previous page

## Specification Information

Style Number	Base Prices													
	Fabric Grades:											Leather Grades:		
	COM	6	7	8	9	10	11	12	13	14	COL	C	E	

## Contract Four-Seat Lounges

### Without Arms

Style Number	COM	6	7	8	9	10	11	12	13	14	COL	C	E
COMFL4	\$6082	\$6241	\$6314	\$6428	\$6791	\$7026	\$7296	\$7483	\$7818	\$8285	\$6251	\$ 9519	\$ 9904

COM/yds = 7¾, COL/sq ft = 170

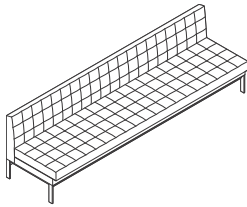

Overall: 30"D 104"W 31"H  
Inside seat height: 22"D 17"H

### With Arms

Style Number	COM	6	7	8	9	10	11	12	13	14	COL	C	E
COMFLA4	\$6427	\$6633	\$6713	\$6847	\$7255	\$7519	\$7825	\$8037	\$8414	\$8940	\$6596	\$10,647	\$11,111

COM/yds = 8¾, COL/sq ft = 192

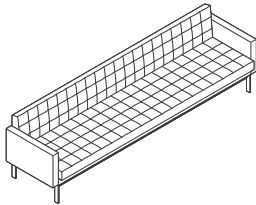

Overall: 30"D 110"W 31"H  
Inside: 22"D 104½"W 17"H

### With Left Arm Facing

Style Number	COM	6	7	8	9	10	11	12	13	14	COL	C	E
COMFLLA4	\$6255	\$6439	\$6511	\$6638	\$7023	\$7270	\$7560	\$7761	\$8119	\$8614	\$6424	\$10,069	\$10,495

COM/yds = 8¼, COL/sq ft = 181

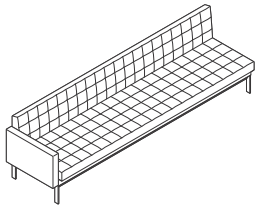

Overall: 30"D 107"W 31"H  
Inside: 22"D 104¾"W 17"H

### With Right Arm Facing

Style Number	COM	6	7	8	9	10	11	12	13	14	COL	C	E
COMFLRA4	\$6255	\$6439	\$6511	\$6638	\$7023	\$7270	\$7560	\$7761	\$8119	\$8614	\$6424	\$10,069	\$10,495

COM/yds = 8¼, COL/sq ft = 181

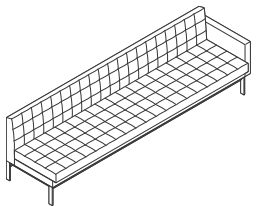

Overall: 30"D 107"W 31"H  
Inside: 22"D 104¾"W 17"H

► Specification Information, continued on next page

# Millbrae Lounge

DESIGN COALESSE DESIGN GROUP

► Specification Information, continued from previous page

## Specification Information

Style Number	Base Prices											Leather Grades:		
	Fabric Grades:											COL	C	E
	COM	6	7	8	9	10	11	12	13	14				

### Contract Lounge Benches

#### One-Seat Bench

COMFLB1	\$2330	\$2330	\$2344	\$2371	\$2452	\$2505	\$2566	\$2609	\$2686	\$2790	\$2621	\$3170	\$3266
---------	--------	--------	--------	--------	--------	--------	--------	--------	--------	--------	--------	--------	--------

COM/yds = 1¾, COL/sq ft = 39

#### 2-Seat Bench

COMFLB2	\$3239	\$3239	\$3263	\$3308	\$3435	\$3518	\$3614	\$3681	\$3802	\$3967	\$3486	\$4413	\$4549
---------	--------	--------	--------	--------	--------	--------	--------	--------	--------	--------	--------	--------	--------

COM/yds = 2¾, COL/sq ft = 60

#### 3-Seat Bench

COMFLB3	\$3781	\$3781	\$3813	\$3862	\$4015	\$4110	\$4224	\$4304	\$4446	\$4641	\$4005	\$5332	\$5511
---------	--------	--------	--------	--------	--------	--------	--------	--------	--------	--------	--------	--------	--------

COM/yds = 3¼, COL/sq ft = 72

#### Four-Seat Bench

COMFLB4	\$4180	\$4187	\$4228	\$4296	\$4508	\$4641	\$4799	\$4909	\$5101	\$5371	\$4349	\$6055	\$6276
---------	--------	--------	--------	--------	--------	--------	--------	--------	--------	--------	--------	--------	--------

COM/yds = 4½, COL/sq ft = 93

### Contract Lounge Round Arm Bolster

COMLPRND	\$ 420	\$ 401	\$ 408	\$ 419	\$ 454	\$ 475	\$ 503	\$ 519	\$ 553	\$ 598	\$ 740	\$ 766	\$ 809
----------	--------	--------	--------	--------	--------	--------	--------	--------	--------	--------	--------	--------	--------

COM/yds = ¾, COL/sq ft = 17

### Contract Lounge Square Arm Bolster

COMLPSQR	\$ 420	\$ 412	\$ 421	\$ 437	\$ 484	\$ 513	\$ 548	\$ 573	\$ 617	\$ 677	\$ 740	\$ 884	\$ 939
----------	--------	--------	--------	--------	--------	--------	--------	--------	--------	--------	--------	--------	--------

COM/yds = 1, COL/sq ft = 22

### Contract Lounge Ganging Kit

COMF1	\$ 96	N.A.	N.A.	N.A.	N.A.	N.A.	N.A.	N.A.	N.A.	N.A.	N.A.	N.A.	N.A.
-------	-------	------	------	------	------	------	------	------	------	------	------	------	------

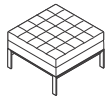

Overall: 26"D 26"W 16½"H

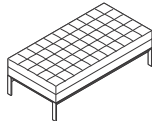

Overall: 26"D 52"W 16½"H

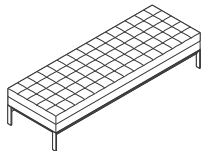

Overall: 26"D 78"W 16½"H

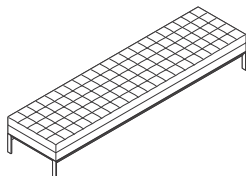

Overall: 26"D 104"W 16½"H



Overall: 18½"D 7"W 7"H



Overall: 18½"D 7"W 7"H

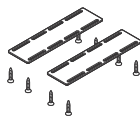

Lounge Seating

# Lagunitas Lounge System 1-Seat Lounges

DESIGN TOAN NGUYEN

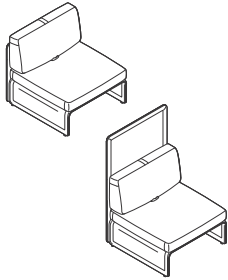

Standard Includes	Required to Specify
<p>► Need help? Product details, see <i>Coalesse Seating and Outdoor Specification Guide</i>.</p> <ul style="list-style-type: none"> <li>• Screen: grade 1 knit</li> <li>• Seat deck: grade 1 knit to match screen</li> <li>• Non-contrasting seat cushion, articulating back cushion and pulls, back corner cushion, and end arm cushions: fabric or leather</li> <li>• Bracket: paint</li> <li>• Six adjustable glides</li> <li>• Ships assembled</li> </ul>	<ol style="list-style-type: none"> <li>1 Style number</li> <li>2 Knit color number for screen</li> <li>3 Fabric or leather color number for non-contrasting seat cushion, articulating back cushion and pulls, and end arm cushions, if selected</li> <li>4 Paint color number for bracket: 4141 Platinum Matte 4710 Low Gloss Black</li> <li>5 Options, if selected (see below)</li> </ol> <p>► See <i>Coalesse Surface Materials Reference Guide</i>.</p>

Options	Price	Required to Specify
<p><b>Surface Materials</b></p> <p><b>Fabric screen</b></p> <ul style="list-style-type: none"> <li>• 1-seat lounge with low-back screen +\$254</li> <li>• 1-seat lounge with low-back screen and two side screens +\$456</li> <li>• 1-seat lounge with high-back screen +\$282</li> <li>• 1-seat lounge with high-back screen and two side screens +\$561</li> </ul> <hr/> <ul style="list-style-type: none"> <li>• Contrasting fabric for screen +\$167</li> <li>• Contrasting fabric for cushion +\$167</li> </ul> <hr/> <ul style="list-style-type: none"> <li>• Contrasting fabric for top and bottom articulating back pulls +\$167</li> </ul> <hr/> <ul style="list-style-type: none"> <li>• Fabric upcharges Prices at right</li> </ul> <hr/> <p><b>Knit screen</b></p> <ul style="list-style-type: none"> <li>• Grade 1 knit screen No cost</li> <li>• Grade 2 knit screen                             <ul style="list-style-type: none"> <li>– 1-seat lounge with low-back screen +\$246</li> <li>– 1-seat lounge with low-back screen and two side screens +\$528</li> <li>– 1-seat lounge with high-back screen +\$281</li> <li>– 1-seat lounge with high-back screen and two side screens +\$635</li> </ul> </li> </ul> <hr/> <p><b>Acrylic backer</b></p> <ul style="list-style-type: none"> <li>• 1-seat lounge with low-back screen +\$ 45</li> <li>• 1-seat lounge with low-back screen and two side screens +\$ 94</li> <li>• 1-seat lounge with high-back screen +\$ 74</li> <li>• 1-seat lounge with high-back screen and two side screens +\$122</li> </ul> <hr/> <ul style="list-style-type: none"> <li>• COM +\$206</li> </ul> <hr/> <ul style="list-style-type: none"> <li>• COL +\$376</li> </ul>		<p>Specify with <i>screen type fabric</i>. Specify with <i>screen type fabric</i>.</p> <p>Specify with <i>screen type fabric</i>. Specify with <i>screen type fabric</i>.</p> <p>Specify with <i>contrasting fabric</i> and select fabric or leather color number. Specify with <i>contrasting fabric</i> and select fabric or leather color number.</p> <p>Specify with <i>contrasting fabric</i> and select fabric or leather color number.</p> <p>Specify fabric color number.</p> <p>Specify with <i>screen type knit</i> and select knit color number.</p> <p>Specify with <i>screen type knit</i> and select knit color number. Specify with <i>screen type knit</i> and select knit color number. Specify with <i>screen type knit</i> and select knit color number. Specify with <i>screen type knit</i> and select knit color number.</p> <p>Specify with <i>acrylic backer</i>. Specify with <i>acrylic backer</i>. Specify with <i>acrylic backer</i>. Specify with <i>acrylic backer</i>. ► See <i>Coalesse Surface Materials Reference Guide</i>.</p> <p>Specify with <i>COM</i> and select fabric color number. ► See <i>Coalesse Surface Materials Reference Guide</i>.</p> <p>Specify with <i>COL</i> and select leather color number. ► See <i>Coalesse Surface Materials Reference Guide</i>.</p>

► Options, continued on next page

*Tip: If contrasting screen is selected, it is required to specify whether seat deck finish will match inner screen or outer screen.*

*Tip: Contrasting fabric for articulating back pulls upcharge is applied one time per style number.*

*Tip: When contrasting fabric for articulating back pulls is selected, only one contrasting fabric can be specified and will apply to all pulls.*

*Tip: For Customer's Own Material or Leather, see necessary requirements, important processing instructions and ordering information.*

► See *Coalesse Surface Materials Reference Guide*.

*Tip: For any portion of the product that requires a COM, the additional upcharge is a one time charge per product.*

*Tip: For any portion of the product that requires a COL, the additional upcharge is a one time charge per product.*



# Lagunitas Lounge System 1-Seat Lounges

DESIGN TOAN NGUYEN

*Tip: For each USB port specified, there is one USB per port.*

► Options, continued from previous page

	Options	Price	Required to Specify
<b>Power/USB Configuration</b>	• One power module: two power in 4710 Low Gloss Black paint	+\$418	Specify with one power module, with two power.
	• One power module: one USB A+C 20W/one power in 4710 Low Gloss Black paint	+\$555	Specify with one power module, with one power/one USB A+C 20W.

**Related Products**

- Bench
- Chaise
- Lagunitas tables
- Lounge booth connector screen and alignment connector

- Page 114
- Pages 106–110
- See *GSA Volume 5b Specification Guide*.
- Pages 116–117

► Specification Information, on next page

# Lagunitas Lounge System 1-Seat Lounges *continued*

DESIGN TOAN NGUYEN

► Options, on previous page

## Specification Information

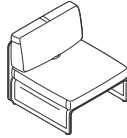

**One articulating back**  
**Overall:** 32¾"W x 34"D x 32¾"H  
**Inside (Lounge):** 32¾"W x 22½"D  
**Inside (Task):** 32¾"W x 17¾"D  
**Seat:** 16"H

Style Number      Base Price

### 1-Seat Lounge with Low-Back Screen

COLAGLL11      \$2653

#### Fabric Upcharges

	Fabric Grades:										Leather Grades:	
	6	7	8	9	10	11	12	13	14	C	E	
Articulating Back Pulls (if top and bottom contrasting pulls are selected)	+\$ 25	+\$ 30	+\$ 41	+\$ 68	+\$ 84	+\$103	+\$118	+\$ 141	+\$ 177	+\$254	+\$ 298	
Seat Cushion	+\$ 116	+\$138	+\$174	+\$289	+\$363	+\$448	+\$510	+\$ 614	+\$ 763	+\$1101	+\$1294	
Back Cushion	+\$ 116	+\$138	+\$174	+\$289	+\$363	+\$448	+\$510	+\$ 614	+\$ 763	+\$1101	+\$1294	
Inside Screen	+\$ 140	+\$170	+\$215	+\$353	+\$445	+\$547	+\$626	+\$ 756	+\$ 935	N.A.	N.A.	
Outside Screen	+\$203	+\$244	+\$313	+\$515	+\$646	+\$795	+\$901	+\$1089	+\$1348	N.A.	N.A.	

*Tip: Articulating back pull fabric upcharges only apply when contrasting pulls are selected.*

**One Articulating Back:** Seat Deck: 2.6 yards, Inside Screen: 1.4 yards, Outside Screen: 1.6 yards, Seat Cushion: 2.2 yards, 48.4 sq ft, Back Cushion: 2.2 yards, 48.4 sq ft, Contrasting Pulls on Articulating Back Cushion: 0.5 yards, 1.1 sq ft

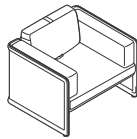

**One articulating back and end arm cushions**  
**Overall:** 49¼"W x 34"D x 32¾"H  
**Seat:** 16"H

Style Number      Base Price

### 1-Seat Lounge with Low-Back Screen and Two Side Screens

COLAGLL13      \$4190

#### Fabric Upcharges

	Fabric Grades:										Leather Grades:	
	6	7	8	9	10	11	12	13	14	C	E	
Articulating Back Pulls (if top and bottom contrasting pulls are selected)	+\$ 25	+\$ 30	+\$ 41	+\$ 68	+\$ 84	+\$ 103	+\$ 118	+\$ 141	+\$ 177	+\$254	+\$ 298	
Seat Cushion	+\$ 134	+\$164	+\$208	+\$343	+\$ 431	+\$ 530	+\$ 601	+\$ 727	+\$ 899	+\$1301	+\$1528	
Back Cushion	+\$ 288	+\$344	+\$440	+\$724	+\$907	+\$1120	+\$1272	+\$1536	+\$1906	+\$2751	+\$3233	
Inside Screen	+\$ 280	+\$332	+\$456	+\$703	+\$884	+\$1091	+\$1237	+\$1494	+\$1852	N.A.	N.A.	
Outside Screen	+\$ 371	+\$443	+\$564	+\$930	+\$1165	+\$1438	+\$1631	+\$1969	+\$2437	N.A.	N.A.	

*Tip: Articulating back pull fabric upcharges only apply when contrasting pulls are selected.*

**One Articulating Back and End Arm Cushions:** Arm: 0, Seat Deck: 1.8 yards, Inside Screen: 4.4 yards, Outside Screen: 5.1 yards, Seat Cushion: 2.6 yards, 57.2 sq ft, Back Cushion: 5.5 yards, 121 sq ft, Contrasting Pulls on Articulating Back Cushion: 0.5 yards, 1.1 sq ft

► Specification Information, continued on next page

# Lagunitas Lounge System 1-Seat Lounges

DESIGN TOAN NGUYEN

► Specification Information, continued from previous page

## Specification Information

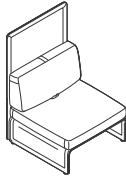

**One articulating back**  
**Overall:** 32¾"W x 34"D x 50"H  
**Inside (Lounge):** 32¾"W x 22½"D  
**Inside (Task):** 32¾"W x 17¾"D  
**Seat:** 16"H

Style Number      Base Price

### 1-Seat Lounge with High-Back Screen

COLAGLH11      \$3072

#### Fabric Upcharges

	Fabric Grades:										Leather Grades:	
	6	7	8	9	10	11	12	13	14	C	E	
Articulating Back Pulls (if top and bottom contrasting pulls are selected)	+\$ 25	+\$ 30	+\$ 41	+\$ 68	+\$ 84	+\$103	+\$118	+\$141	+\$ 177	+\$ 254	+\$ 298	
Seat Cushion	+\$ 116	+\$138	+\$174	+\$289	+\$363	+\$448	+\$510	+\$614	+\$ 763	+\$1101	+\$1294	
Back Cushion	+\$ 116	+\$138	+\$174	+\$289	+\$363	+\$448	+\$510	+\$614	+\$ 763	+\$1101	+\$1294	
Inside Screen	+\$140	+\$170	+\$215	+\$353	+\$445	+\$549	+\$626	+\$756	+\$ 935	N.A.	N.A.	
Outside Screen	+\$203	+\$244	+\$313	+\$515	+\$646	+\$796	+\$901	+\$1089	+\$1348	N.A.	N.A.	

*Tip: Articulating back pulls fabric upcharges only apply when contrasting pulls are selected.*

**One Articulating Back:** Seat Deck: 2.6 yards, Inside Screen: 1.4 yards, Outside Screen: 1.6 yards, Seat Cushion: 2.2 yards, 48.4 sq ft, Back Cushion: 2.2 yards, 48.4 sq ft, Contrasting Pulls on Articulating Back Cushion: 0.5 yards, 1.1 sq ft

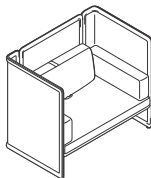

**One articulating back and end arm cushions**  
**Overall:** 49¼"W x 34"D x 50"H  
**Seat:** 16"H

Style Number      Base Price

### 1-Seat Lounge with High-Back Screen and Two Side Screens

COLAGLH13      \$5589

#### Fabric Upcharges

	Fabric Grades:										Leather Grades:	
	6	7	8	9	10	11	12	13	14	C	E	
Articulating Back Pulls (if top and bottom contrasting pulls are selected)	+\$ 25	+\$ 30	+\$ 41	+\$ 68	+\$ 84	+\$ 103	+\$ 118	+\$ 141	+\$ 177	+\$ 254	+\$ 298	
Seat Cushion	+\$ 134	+\$ 164	+\$208	+\$343	+\$ 431	+\$ 530	+\$ 601	+\$ 727	+\$ 899	+\$1301	+\$1528	
Back Cushion	+\$ 288	+\$344	+\$440	+\$724	+\$ 907	+\$1120	+\$1272	+\$1536	+\$1906	+\$2751	+\$3233	
Inside Screen	+\$ 280	+\$332	+\$456	+\$703	+\$ 884	+\$1091	+\$1237	+\$1494	+\$1852	N.A.	N.A.	
Outside Screen	+\$ 371	+\$443	+\$564	+\$930	+\$1165	+\$1438	+\$1631	+\$1969	+\$2437	N.A.	N.A.	

*Tip: Articulating back pulls fabric upcharges only apply when contrasting pulls are selected.*

**One Articulating Back and End Arm Cushions:** Arm: 0, Seat Deck: 1.8 yards, Inside Screen: 4.4 yards, Outside Screen: 5.1 yards, Seat Cushion: 2.6 yards, 57.2 sq ft, Back Cushion: 5.5 yards, 121 sq ft, Contrasting Pulls on Articulating Back Cushion: 0.5 yards, 1.1 sq ft

Lounge Seating

# Lagunitas Lounge System 2-Seat Lounges

DESIGN TOAN NGUYEN

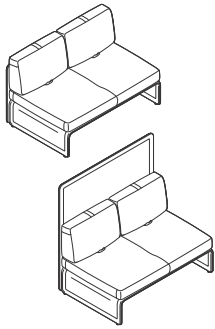

Standard Includes		Required to Specify
<ul style="list-style-type: none"> <li>▶ Need help? Product details, see <i>Coalesse Seating and Outdoor Specification Guide</i>.</li> <li>• Screen: grade 1 knit</li> <li>• Seat deck: grade 1 knit to match screen</li> <li>• Non-contrasting seat cushion, articulating back cushion and pulls, back corner cushion, and end arm cushions: fabric or leather</li> <li>• Bracket: paint</li> <li>• Six adjustable glides</li> <li>• Ships assembled</li> </ul>		<ol style="list-style-type: none"> <li>1 Style number</li> <li>2 Handedness (see below under Required Selections)</li> <li>3 Knit color number for screen</li> <li>4 Fabric or leather color number for non-contrasting seat cushion, articulating back cushion and pulls, back corner cushion, and end arm cushions, if selected</li> <li>5 Paint color number for bracket: 4141 Platinum Matte 4710 Low Gloss Black</li> <li>6 Options, if selected (see below)</li> </ol> <p>▶ See <i>Coalesse Surface Materials Reference Guide</i>.</p>

	Required Sections	Price	Required to Specify
<b>Handedness</b>	• Left-hand, 2-seat lounges only (seated position)	No cost	Specify with <i>left-hand configuration</i> .
	• Right-hand, 2-seat lounges only (seated position)	No cost	Specify with <i>right-hand configuration</i> .

	Options	Price	Required to Specify	
<b>Surface Materials</b>	<b>Fabric screen</b>			
	• 2-seat lounge with low-back screen	+\$210	Specify with <i>screen type fabric</i> .	
	• 2-seat lounge with low-back screen and one side screen	+\$316	Specify with <i>screen type fabric</i> .	
	• 2-seat lounge with low-back screen and two side screens	+\$418	Specify with <i>screen type fabric</i> .	
	• 2-seat lounge with high-back screen	+\$246	Specify with <i>screen type fabric</i> .	
	• 2-seat lounge with high-back screen and one side screen	+\$386	Specify with <i>screen type fabric</i> .	
	• 2-seat lounge with high-back screen and two side screens	+\$525	Specify with <i>screen type fabric</i> .	
	• Contrasting fabric for screen	+\$167	Specify with <i>contrasting fabric</i> and select fabric or leather color number.	
	• Contrasting fabric for cushion	+\$167	Specify with <i>contrasting fabric</i> and select fabric or leather color number.	
	• Contrasting fabric for top and bottom articulating back pulls	+\$167	Specify with <i>contrasting fabric</i> and select fabric or leather color number.	
	• Fabric upcharges	Prices at right	Specify fabric color number.	
		<b>Knit screen</b>		
	• Grade 1 knit screen	No cost	Specify with <i>screen type knit</i> and select knit color number.	
• Grade 2 knit screen				
– 2-seat lounge with low-back screen	+\$317	Specify with <i>screen type knit</i> and select knit color number.		
– 2-seat lounge with low-back screen and one side screen	+\$494	Specify with <i>screen type knit</i> and select knit color number.		
– 2-seat lounge with low-back screen and two side screens	+\$669	Specify with <i>screen type knit</i> and select knit color number.		
– 2-seat lounge with high-back screen	+\$353	Specify with <i>screen type knit</i> and select knit color number.		
– 2-seat lounge with high-back screen and one side screen	+\$566	Specify with <i>screen type knit</i> and select knit color number.		
– 2-seat lounge with high-back screen and two side screens	+\$775	Specify with <i>screen type knit</i> and select knit color number.		

▶ Options, continued on next page

*Tip: If contrasting screen is selected, it is required to specify whether seat deck finish will match inner screen or outer screen.*

*Tip: Contrasting fabric for articulating back pulls upcharge is applied one time per style number.*

*Tip: When contrasting fabric for articulating back pulls is selected, only one contrasting fabric can be specified and will apply to all pulls.*

# Lagunitas Lounge System 2-Seat Lounges

DESIGN TOAN NGUYEN

► Options, continued from previous page

	Options	Price	Required to Specify
<b>Surface Materials, continued</b>	<b>Acrylic backer</b>		
	• 2-seat lounge with low-back screen	+\$ 72	Specify with acrylic backer.
	• 2-seat lounge with low-back screen and one side screen	+\$ 111	Specify with acrylic backer.
	• 2-seat lounge with low-back screen and two side screens	+\$ 150	Specify with acrylic backer.
	• 2-seat lounge with high-back screen	+\$ 111	Specify with acrylic backer.
	• 2-seat lounge with low-back screen and one side screen	+\$ 168	Specify with acrylic backer.
	• 2-seat lounge with high-back screen and two side screens	+\$ 224	Specify with acrylic backer. ► See Coalesse Surface Materials Reference Guide.
	• COM	+\$ 206	Specify with COM and select fabric color number. ► See Coalesse Surface Materials Reference Guide.
	• COL	+\$ 376	Specify with COL and select leather color number. ► See Coalesse Surface Materials Reference Guide.
	<b>Power/USB Configuration</b>	• One power module: two power in 4710 Low Gloss Black paint	+\$ 418
• One power module: one USB A+C 20W/ one power in 4710 Low Gloss Black paint		+\$ 555	Specify with one power module, with one power/one USB A+C 20W.
• Two power modules: two power each in 4710 Low Gloss Black paint		+\$ 836	Specify with two power modules, with two power.
• Two power modules: one USB A+C 20W/ one power each in 4710 Low Gloss Black paint		+\$1110	Specify with two power modules, with one power/one USB A+C 20W.
<b>Related Products</b>		• Bench • Chaise • Lagunitas tables • Lounge booth connector screen and alignment connector	

Tip: For Customer's Own Material or Leather, see necessary requirements, important processing instructions and ordering information.  
► See Coalesse Surface Materials Reference Guide.

Tip: For any portion of the product that requires a COM, the additional upcharge is a one time charge per product.

Tip: For any portion of the product that requires a COL, the additional upcharge is a one time charge per product.

Tip: For each USB port specified, there is one USB per port.

► Specification Information, on next page

# Lagunitas Lounge System 2-Seat Lounges *continued*

DESIGN TOAN NGUYEN

► Options, on previous page

## Specification Information

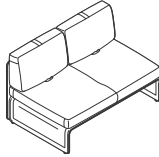

**Two articulating backs**  
**Overall:** 51¼"W x 34"D x 32¾"H  
**Inside (Lounge):** 51¼"W x 22½"D  
**Inside (Task):** 51¼"W x 17¾"D  
**Seat:** 16"H

Style Number      Base Price

### 2-Seat Lounge with Low-Back Screen

COLAGLL21      \$3984

#### Fabric Upcharges

	Fabric Grades:										Leather Grades:	
	6	7	8	9	10	11	12	13	14	C	E	
Articulating Back Pulls (if top and bottom contrasting pulls are selected)	+\$ 25	+\$ 30	+\$ 41	+\$ 68	+\$ 84	+\$ 103	+\$ 118	+\$ 141	+\$ 177	+\$ 254	+\$ 298	
Seat Cushion	+\$ 134	+\$ 164	+\$208	+\$343	+\$431	+\$ 530	+\$ 601	+\$ 727	+\$ 899	+\$1301	+\$1528	
Back Cushion	+\$ 194	+\$ 231	+\$294	+\$490	+\$612	+\$ 756	+\$ 856	+\$1034	+\$ 1281	+\$1850	+\$2175	
Inside Screen	+\$ 212	+\$ 251	+\$319	+\$527	+\$661	+\$ 818	+\$ 921	+\$ 1117	+\$1385	N.A.	N.A.	
Outside Screen	+\$268	+\$320	+\$405	+\$670	+\$842	+\$1042	+\$1180	+\$1425	+\$1765	N.A.	N.A.	

*Tip: Articulating back pull fabric upcharges only apply when contrasting pulls are selected.*

**Two Articulating Backs:** Seat Deck: 3.4 yards, Inside Screen: 2 yards, Outside Screen: 2.2 yards, Seat Cushion: 2.6 yards, 57.2 sq ft, Back Cushion: 3.7 yards, 81.4 sq ft, Contrasting Pulls on Articulating Back Cushions: 0.5 yards, 2.2 sq ft

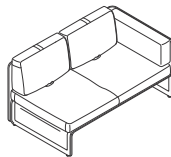

**Two articulating backs**  
**Overall:** 59¾"W x 34"D x 32¾"H  
**Seat:** 16"H

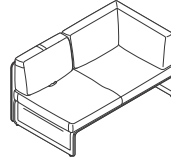

**One articulating back and one corner cushion**  
**Overall:** 59¾"W x 34"D x 32¾"H  
**Seat:** 16"H

Style Number      Base Price

### 2-Seat Lounge with Low-Back Screen and One Side Screen

COLAGLL22      \$4752

#### Fabric Upcharges

	Fabric Grades:										Leather Grades:	
	6	7	8	9	10	11	12	13	14	C	E	
Articulating Back Pulls (if top and bottom contrasting pulls are selected)	+\$ 25	+\$ 30	+\$ 41	+\$ 68	+\$ 84	+\$ 103	+\$ 118	+\$ 141	+\$ 177	+\$ 254	+\$ 298	
Seat Cushion	+\$ 134	+\$164	+\$208	+\$ 343	+\$ 431	+\$ 530	+\$ 601	+\$ 727	+\$ 899	+\$1301	+\$1528	
Back Cushion	+\$244	+\$294	+\$373	+\$ 619	+\$ 775	+\$ 959	+\$1087	+\$ 1311	+\$1628	+\$2352	+\$2762	
Inside Screen	+\$257	+\$310	+\$393	+\$650	+\$ 820	+\$1011	+\$1145	+\$1382	+\$ 1713	N.A.	N.A.	
Outside Screen	+\$336	+\$398	+\$506	+\$835	+\$1049	+\$1297	+\$1468	+\$1774	+\$2199	N.A.	N.A.	

*Tip: Articulating back pull fabric upcharges only apply when contrasting pulls are selected.*

**Two Articulating Backs:** Arm: 0, Seat Deck: 2.7 yards, Inside Screen: 3.5 yards, Outside Screen: 3.9 yards, Seat Cushion: 2.6 yards, 57.2 sq ft, Back Cushion: 4.7 yards, 103.4 sq ft, Contrasting Pulls on Articulating Back Cushions: 0.5 yards, 2.2 sq ft

**One Articulating Back and One Corner Cushion:** Arm: 0, Seat Deck: 2.7 yards, Inside Screen: 3.5 yards, Outside Screen: 3.9 yards, Seat Cushion: 2.6 yards, 57.2 sq ft, Back Cushion: 4.7 yards, 103.4 sq ft, Contrasting Pulls on Articulating Back Cushion: 0.5 yards, 1.1 sq ft

► Specification Information, continued on next page

# Lagunitas Lounge System 2-Seat Lounges

DESIGN TOAN NGUYEN

► Specification Information, continued from previous page

## Specification Information

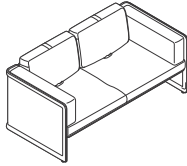

**Two articulating backs**  
**Overall:** 67¾"W x 34"D x 32¾"H  
**Seat:** 16"H

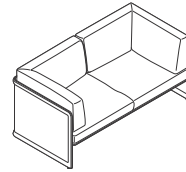

**Two corner cushions**  
**Overall:** 67¾"W x 34"D x 32¾"H  
**Seat:** 16"H

Style Number      Base Price

### 2-Seat Lounge with Low-Back Screen and Two Side Screens

COLAGLL23      \$5520

#### Fabric Upcharges

	Fabric Grades:										Leather Grades:	
	6	7	8	9	10	11	12	13	14	C	E	
Articulating Back Pulls (if top and bottom contrasting pulls are selected)	+\$ 25	+\$ 30	+\$ 41	+\$ 68	+\$ 84	+\$ 103	+\$ 118	+\$ 141	+\$ 177	+\$ 254	+\$ 298	
Seat Cushion	+\$ 151	+\$ 182	+\$ 231	+\$ 383	+\$ 478	+\$ 592	+\$ 669	+\$ 808	+\$1000	+\$1449	+\$1704	
Back Cushion	+\$362	+\$433	+\$548	+\$ 907	+\$ 1141	+\$1410	+\$1596	+\$1927	+\$2387	+\$3451	+\$4056	
Inside Screen	+\$324	+\$386	+\$491	+\$ 807	+\$1015	+\$1253	+\$1421	+\$1717	+\$2129	N.A.	N.A.	
Outside Screen	+\$ 417	+\$498	+\$634	+\$1047	+\$1315	+\$1623	+\$1839	+\$2221	+\$2752	N.A.	N.A.	

*Tip: Articulating back pull fabric upcharges only apply when contrasting pulls are selected.*

**Two Articulating Backs:** Arm: 0, Seat Deck: 1.6 yards, Inside Screen: 4.9 yards, Outside Screen: 5.6 yards, Seat Cushion: 2.9 yards, 63.8 sq ft, Back Cushion: 6.9 yards, 151.8 sq ft, Contrasting Pulls on Articulating Back Cushions: 0.5 yards, 2.2 sq ft

**Two Corner Cushions:** Arm: 0, Seat Deck: 1.6 yards, Inside Screen: 4.9 yards, Outside Screen: 5.6 yards, Seat Cushion: 2.9 yards, 63.8 sq ft, Back Cushion: 6.9 yards, 151.8 sq ft

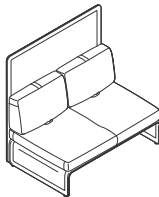

**Two articulating backs**  
**Overall:** 51¼"W x 34"D x 50"H  
**Inside (Lounge):** 51¼"W x 22½"D  
**Inside (Task):** 51¼"W x 17¾"D  
**Seat:** 16"H

Style Number      Base Price

### 2-Seat Lounge with High-Back Screen

COLAGLH21      \$4820

#### Fabric Upcharges

	Fabric Grades:										Leather Grades:	
	6	7	8	9	10	11	12	13	14	C	E	
Articulating Back Pulls (if top and bottom contrasting pulls are selected)	+\$ 25	+\$ 30	+\$ 41	+\$ 68	+\$ 84	+\$ 103	+\$ 118	+\$ 141	+\$ 177	+\$ 254	+\$ 298	
Seat Cushion	+\$ 134	+\$164	+\$208	+\$343	+\$431	+\$ 530	+\$ 601	+\$ 727	+\$ 899	+\$ 1301	+\$1528	
Back Cushion	+\$ 194	+\$231	+\$294	+\$490	+\$612	+\$ 756	+\$ 856	+\$1034	+\$1281	+\$1850	+\$2175	
Inside Screen	+\$212	+\$251	+\$319	+\$527	+\$661	+\$ 818	+\$ 921	+\$ 1117	+\$1385	N.A.	N.A.	
Outside Screen	+\$268	+\$320	+\$405	+\$670	+\$842	+\$1042	+\$1180	+\$1425	+\$1765	N.A.	N.A.	

*Tip: Articulating back pull fabric upcharges only apply when contrasting pulls are selected.*

**Two Articulating Backs:** Seat Deck: 3.4 yards, Inside Screen: 2 yards, Outside Screen: 2.2 yards, Seat Cushion: 2.6 yards, 57.2 sq ft, Back Cushion: 3.7 yards, 81.4 sq ft, Contrasting Pulls on Articulating Back Cushions: 0.5 yards, 2.2 sq ft

► Specification Information, continued on next page

# Lagunitas Lounge System 2-Seat Lounges *continued*

DESIGN TOAN NGUYEN

► Specification Information, continued from previous page

## Specification Information

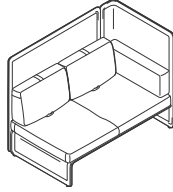

**Two articulating backs**  
**Overall:** 59<sup>3</sup>/<sub>8</sub>"W x 34"D x 50"H  
**Seat:** 16"H

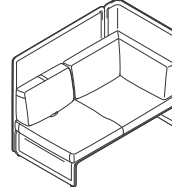

**One articulating back and one corner cushion**  
**Overall:** 59<sup>3</sup>/<sub>8</sub>"W x 34"D x 50"H  
**Seat:** 16"H

Style Number      Base Price

### 2-Seat Lounge with High-Back Screen and One Side Screen

COLAGLH22      \$6079

#### Fabric Upcharges

	Fabric Grades:								Leather Grades:		
	6	7	8	9	10	11	12	13	14	C	E
Articulating Back Pulls (if top and bottom contrasting pulls are selected)	+\$ 25	+\$ 30	+\$ 41	+\$ 68	+\$ 84	+\$ 103	+\$ 118	+\$ 141	+\$ 177	+\$ 254	+\$ 298
Seat Cushion	+\$ 134	+\$164	+\$208	+\$343	+\$ 431	+\$ 530	+\$ 601	+\$ 727	+\$ 899	+\$ 1301	+\$1528
Back Cushion	+\$244	+\$294	+\$373	+\$619	+\$ 775	+\$ 959	+\$1087	+\$ 1311	+\$1628	+\$2352	+\$2762
Inside Screen	+\$257	+\$310	+\$393	+\$650	+\$ 820	+\$ 1011	+\$1145	+\$1382	+\$ 1713	N.A.	N.A.
Outside Screen	+\$336	+\$398	+\$506	+\$835	+\$1049	+\$1297	+\$1468	+\$1774	+\$2199	N.A.	N.A.

*Tip: Articulating back pull fabric upcharges only apply when contrasting pulls are selected.*

**Three Articulating Backs:** Arm: 0, Seat Deck: 2.7 yards, Inside Screen: 3.5 yards, Outside Screen: 3.9 yards, Seat Cushion: 2.6 yards, 57.2 sq ft, Back Cushion: 4.7 yards, 103.4 sq ft, Contrasting Pulls on Articulating Back Cushions: 0.5 yards, 2.2 sq ft  
**One Articulating Back and One Corner Cushion:** Arm: 0, Seat Deck: 2.7 yards, Inside Screen: 3.5 yards, Outside Screen: 3.9 yards, Seat Cushion: 2.6 yards, 57.2 sq ft, Back Cushion: 4.7 yards, 103.4 sq ft, Contrasting Pulls on Articulating Back Cushion: 0.5 yards, 1.1 sq ft

► Specification Information, continued on next page



# Lagunitas Lounge System 2-Seat Lounges

DESIGN TOAN NGUYEN

► Specification Information, continued from previous page

## Specification Information

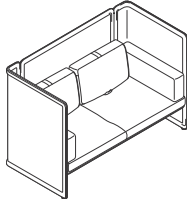

**Two articulating backs**  
**Overall:** 67<sup>3</sup>/<sub>4</sub>"W x 34"D x 50"H  
**Seat:** 16"H

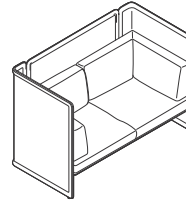

**Two corner cushions**  
**Overall:** 67<sup>3</sup>/<sub>4</sub>"W x 34"D x 50"H  
**Seat:** 16"H

Style Number      Base Price

### 2-Seat Lounge with High-Back Screen and Two Side Screens

COLAGLH23      \$7336

#### Fabric Upcharges

	Fabric Grades:								Leather Grades:		
	6	7	8	9	10	11	12	13	14	C	E
Articulating Back Pulls (if top and bottom contrasting pulls are selected)	+\$ 25	+\$ 30	+\$ 41	+\$ 68	+\$ 84	+\$ 103	+\$ 118	+\$ 141	+\$ 177	+\$ 254	+\$ 298
Seat Cushion	+\$ 151	+\$ 182	+\$ 231	+\$ 383	+\$ 478	+\$ 592	+\$ 669	+\$ 808	+\$1000	+\$1449	+\$1704
Back Cushion	+\$362	+\$433	+\$548	+\$ 907	+\$ 1141	+\$1410	+\$1596	+\$1927	+\$2387	+\$3451	+\$4056
Inside Screen	+\$324	+\$386	+\$491	+\$ 807	+\$1015	+\$1253	+\$ 1421	+\$ 1717	+\$2129	N.A.	N.A.
Outside Screen	+\$ 417	+\$498	+\$634	+\$1047	+\$1315	+\$1623	+\$1839	+\$2221	+\$2752	N.A.	N.A.

*Tip: Articulating back pull fabric upcharges only apply when contrasting pulls are selected.*

**Two Articulating Backs:** Arm: 0, Seat Deck: 1.6 yards, Inside Screen: 4.9 yards, Outside Screen: 5.6 yards, Seat Cushion: 2.9 yards, 63.8 sq ft, Back Cushion: 6.9 yards, 151.8 sq ft, Contrasting Pulls on Articulating Back Cushions: 0.5 yards, 2.2 sq ft

**Two Corner Cushions:** Arm: 0, Seat Deck: 1.6 yards, Inside Screen: 4.9 yards, Outside Screen: 5.6 yards, Seat Cushion: 2.9 yards, 63.8 sq ft, Back Cushion: 6.9 yards, 151.8 sq ft

# Lagunitas Lounge System 3-Seat Lounges

DESIGN TOAN NGUYEN

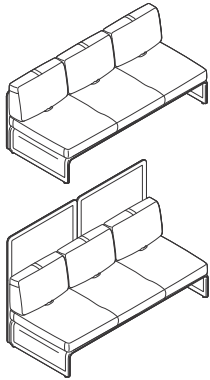

Standard Includes		Required to Specify
<ul style="list-style-type: none"> <li>▶ Need help? Product details, see <i>Coalesse Seating and Outdoor Specification Guide</i>.</li> <li>• Screen: grade 1 knit</li> <li>• Seat deck: grade 1 knit to match screen</li> <li>• Non-contrasting seat cushion, articulating back cushion and pulls, back corner cushion, and end arm cushions: fabric or leather</li> <li>• Bracket: paint</li> <li>• Eight adjustable glides</li> <li>• Ships assembled</li> </ul>		<ol style="list-style-type: none"> <li>1 Style number</li> <li>2 Handedness (see below under Required Selections)</li> <li>3 Knit color number for screen</li> <li>4 Fabric or leather color number for non-contrasting seat cushion, articulating back cushion and pulls, back corner cushion, and end arm cushions, if selected</li> <li>5 Paint color number for bracket:                     <ul style="list-style-type: none"> <li>4141 Platinum Matte</li> <li>4710 Low Gloss Black</li> </ul> </li> <li>6 Options, if selected (see below)</li> </ol> ▶ See <i>Coalesse Surface Materials Reference Guide</i> .

	Required Sections	Price	Required to Specify
<b>Handedness</b>	• Left-hand, 3-seat lounges only (seated position)	No cost	Specify <i>left-hand configuration</i> .
	• Right-hand, 3-seat lounges only (seated position)	No cost	Specify <i>right-hand configuration</i> .

	Options	Price	Required to Specify
<b>Surface Materials</b>	<b>Fabric screen</b>		
	• 3-seat lounge with low-back screen	+\$316	Specify <i>with screen type fabric</i> .
	• 3-seat lounge with low-back screen and one side screen	+\$418	Specify <i>with screen type fabric</i> .
	• 3-seat lounge with low-back screen and two side screens	+\$525	Specify <i>with screen type fabric</i> .
	• 3-seat lounge with high-back screen	+\$352	Specify <i>with screen type fabric</i> .
	• 3-seat lounge with high-back screen and one side screen	+\$456	Specify <i>with screen type fabric</i> .
	• 3-seat lounge with high-back screen and two side screens	+\$597	Specify <i>with screen type fabric</i> .
	• Contrasting fabric for screen	+\$167	Specify <i>with contrasting fabric</i> and select fabric or leather color number.
	• Contrasting fabric for cushion	+\$167	Specify <i>with contrasting fabric</i> and select fabric or leather color number.
	• Contrasting fabric for top and bottom articulating back pulls	+\$167	Specify <i>with contrasting fabric</i> and select fabric or leather color number.
	• Fabric upcharges	Prices at right	Specify fabric color number.
	<b>Knit screen</b>		
	• Grade 1 knit screen	No cost	Specify <i>with screen type knit</i> and select knit color number.
	• Grade 2 knit screen		
	– 3-seat lounge with low-back screen	+\$388	Specify <i>with screen type knit</i> and select knit color number.
	– 3-seat lounge with low-back screen and one side screen	+\$599	Specify <i>with screen type knit</i> and select knit color number.
	– 3-seat lounge with low-back screen and two side screens	+\$808	Specify <i>with screen type knit</i> and select knit color number.
	– 3-seat lounge with high-back screen	+\$420	Specify <i>with screen type knit</i> and select knit color number.
	– 3-seat lounge with high-back screen and one side screen	+\$668	Specify <i>with screen type knit</i> and select knit color number.
	– 3-seat lounge with high-back screen and two side screens	+\$915	Specify <i>with screen type knit</i> and select knit color number.

▶ Options, continued on next page

*Tip: If contrasting screen is selected, it is required to specify whether seat deck finish will match inner screen or outer screen.*

*Tip: Contrasting fabric for articulating back pulls upcharge is applied one time per style number.*

*Tip: When contrasting fabric for articulating back pulls is selected, only one contrasting fabric can be specified and will apply to all pulls.*

# Lagunitas Lounge System 3-Seat Lounges

DESIGN TOAN NGUYEN

► Options, continued from previous page

	Options	Price	Required to Specify
<b>Surface Materials, continued</b>	<b>Acrylic backer</b>		
	• 3-seat lounge with low-back screen	+\$ 98	Specify with acrylic backer.
	• 3-seat lounge with low-back screen and one side screen	+\$ 147	Specify with acrylic backer.
	• 3-seat lounge with low-back screen and two side screens	+\$ 199	Specify with acrylic backer.
	• 3-seat lounge with high-back screen	+\$ 168	Specify with acrylic backer.
	• 3-seat lounge with high-back screen and one side screen	+\$ 216	Specify with acrylic backer.
	• 3-seat lounge with high-back screen and two side screens	+\$ 269	Specify with acrylic backer. ► See Coalesse Surface Materials Reference Guide.
	• COM	+\$ 206	Specify with COM and select fabric color number. ► See Coalesse Surface Materials Reference Guide.
	• COL	+\$ 376	Specify with COL and select leather color number. ► See Coalesse Surface Materials Reference Guide
<b>Power/USB Configuration</b>	• One power module: two power in 4710 Low Gloss Black paint	+\$ 418	Specify with one power module, with two power.
	• One power module: one USB A+C 20W/one power in 4710 Low Gloss Black paint	+\$ 555	Specify with one power module, with one power/one USB A+C 20W.
	• Two power modules: two power each in 4710 Low Gloss Black paint	+\$ 836	Specify with two power modules, with two power.
	• Two power modules: one USB A+C 20W/one power each in 4710 Low Gloss Black paint	+\$1110	Specify with two power modules, with one power/one USB A+C 20W.
<b>Related Products</b>	• Bench		► Page 114
	• Chaise		► Pages 106–110
	• Lagunitas tables		► See GSA Volume 5b Specification Guide.
	• Lounge booth connector screen and alignment connector		► Pages 116–117

► Specification Information, on next page

*Tip: For Customer's Own Material or Leather, see necessary requirements, important processing instructions and ordering information.*  
► See Coalesse Surface Materials Reference Guide.

*Tip: For any portion of the product that requires a COM, the additional upcharge is a one time charge per product.*

*Tip: For any portion of the product that requires a COL, the additional upcharge is a one time charge per product.*

*Tip: For each USB port specified, there is one USB per port.*

# Lagunitas Lounge System 3-Seat Lounges *continued*

DESIGN TOAN NGUYEN

► Options, on previous page

## Specification Information

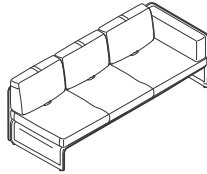

**Three articulating backs**  
**Overall:** 76¾"W x 34"D x 32¾"H  
**Inside (Lounge):** 76¾"W x 22½"D  
**Inside (Task):** 76¾"W x 17¾"D  
**Seat:** 16"H

Style Number      Base Price

### 3-Seat Lounge with Low-Back Screen

COLAGLL31      \$5452

#### Fabric Upcharges

	Fabric Grades:										Leather Grades:	
	6	7	8	9	10	11	12	13	14	C	E	
Articulating Back Pulls (if top and bottom contrasting pulls are selected)	+\$ 25	+\$ 30	+\$ 41	+\$ 68	+\$ 84	+\$ 103	+\$ 118	+\$ 141	+\$ 177	+\$ 254	+\$ 298	
Seat Cushion	+\$188	+\$225	+\$286	+\$473	+\$ 594	+\$ 734	+\$ 833	+\$1007	+\$1246	+\$1801	+\$2118	
Back Cushion	+\$288	+\$344	+\$440	+\$724	+\$ 907	+\$1120	+\$1272	+\$1536	+\$1906	+\$2751	+\$3233	
Inside Screen	+\$277	+\$330	+\$419	+\$691	+\$ 866	+\$1071	+\$ 1213	+\$1467	+\$ 1818	N.A.	N.A.	
Outside Screen	+\$347	+\$416	+\$530	+\$876	+\$1096	+\$1360	+\$1537	+\$1857	+\$2303	N.A.	N.A.	

*Tip: Articulating back pull fabric upcharges only apply when contrasting pulls are selected.*

**Three Articulating Backs:** Seat Deck: 3.6 yards, Inside Screen: 3.2 yards, Outside Screen: 3.7 yards, Seat Cushion: 3.6 yards, 79.2 sq ft, Back Cushion: 5.5 yards, 121 sq ft, Contrasting Pulls on Articulating Back Cushions: 0.5 yards, 3.3 sq ft

► Specification Information, continued on next page

# Lagunitas Lounge System 3-Seat Lounges

DESIGN TOAN NGUYEN

► Specification Information, continued from previous page

## Specification Information

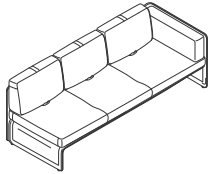

**Three articulating backs**  
**Overall:** 85"W x 34"D x 32<sup>3</sup>/<sub>8</sub>"H  
**Seat:** 16"H

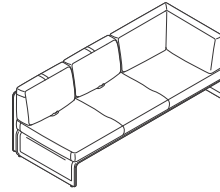

**Two articulating backs and one corner cushion**  
**Overall:** 85"W x 34"D x 32<sup>3</sup>/<sub>8</sub>"H  
**Seat:** 16"H

Style Number      Base Price

### 3-Seat Lounge with Low-Back Screen and One Side Screen

COLAGLL32      \$6217

#### Fabric Upcharges

	Fabric Grades:										Leather Grades:	
	6	7	8	9	10	11	12	13	14	C	E	
Articulating Back Pulls (if top and bottom contrasting pulls are selected)	+\$ 25	+\$ 30	+\$ 41	+\$ 68	+\$ 84	+\$ 103	+\$ 118	+\$ 141	+\$ 177	+\$ 254	+\$ 298	
Seat Cushion	+\$180	+\$ 214	+\$ 269	+\$ 447	+\$ 564	+\$ 695	+\$ 786	+\$ 950	+\$ 1177	+\$1701	+\$1999	
Back Cushion	+\$341	+\$406	+\$ 517	+\$ 856	+\$1075	+\$1327	+\$1504	+\$ 1816	+\$2252	+\$3251	+\$3822	
Inside Screen	+\$332	+\$398	+\$ 511	+\$ 843	+\$1056	+\$1306	+\$ 1481	+\$ 1786	+\$2215	N.A.	N.A.	
Outside Screen	+\$428	+\$514	+\$650	+\$1081	+\$1356	+\$1673	+\$1895	+\$2292	+\$2839	N.A.	N.A.	

*Tip: Articulating back pull fabric upcharges only apply when contrasting pulls are selected.*

**Three Articulating Backs:** Arm: 0, Seat Deck: 2.3 yards, Inside Screen: 4.6 yards, Outside Screen: 5.4 yards, Seat Cushion: 3.4 yards, 74.8 sq ft, Back Cushion: 6.5 yards, 143 sq ft, Contrasting Pulls on Articulating Back Cushions: 0.5 yards, 3.3 sq ft

**Two Articulating Backs and One Corner Cushion:** Arm: 0, Seat Deck: 2.3 yards, Inside Screen: 4.6 yards, Outside Screen: 5.4 yards, Seat Cushion: 3.4 yards, 74.8 sq ft, Back Cushion: 6.5 yards, 143 sq ft, Contrasting Pulls on Articulating Back Cushions: 0.5 yards, 2.2 sq ft

► Specification Information, continued on next page

# Lagunitas Lounge System 3-Seat Lounges *continued*

DESIGN TOAN NGUYEN

► Specification Information, continued from previous page

## Specification Information

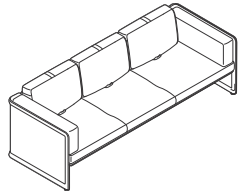

**Three articulating backs**  
**Overall:** 93¼"W x 34"D x 32¾"H  
**Seat:** 16"H

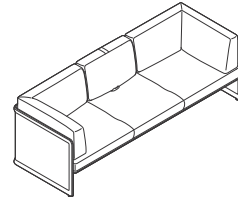

**One articulating back and two corner cushions**  
**Overall:** 93¼"W x 34"D x 32¾"H  
**Seat:** 16"H

Style Number      Base Price

### 3-Seat Lounge with Low-Back Screen and Two Side Screens

COLAGLL33      \$6987

#### Fabric Upcharges

	Fabric Grades:										Leather Grades:	
	6	7	8	9	10	11	12	13	14	C	E	
Articulating Back Pulls (if top and bottom contrasting pulls are selected)	+\$ 25	+\$ 30	+\$ 41	+\$ 68	+\$ 84	+\$103	+\$ 118	+\$ 141	+\$ 177	+\$ 254	+\$ 298	
Seat Cushion	+\$ 188	+\$225	+\$286	+\$ 473	+\$ 594	+\$ 734	+\$ 833	+\$1007	+\$1246	+\$ 1801	+\$2118	
Back Cushion	+\$454	+\$544	+\$692	+\$ 1146	+\$1436	+\$1776	+\$2012	+\$2427	+\$3012	+\$4350	+\$5114	
Inside Screen	+\$392	+\$467	+\$594	+\$ 981	+\$1230	+\$1519	+\$1722	+\$2079	+\$2577	N.A.	N.A.	
Outside Screen	+\$503	+\$595	+\$761	+\$1255	+\$1579	+\$1949	+\$2208	+\$2669	+\$3308	N.A.	N.A.	

*Tip: Articulating back pull fabric upcharges only apply when contrasting pulls are selected.*

**Three Articulating Backs:** Arm: 0, Seat Deck: 2 yards, Inside Screen: 6.1 yards, Outside Screen: 7.1 yards, Seat Cushion: 3.6 yards, 79.2 sq ft, Back Cushion: 8.7 yards, 191.4 sq ft, Contrasting Pulls on Articulating Back Cushions: 0.5 yards, 3.3 sq ft

**One Articulating Back and Two Corner Cushions:** Arm: 0, Seat Deck: 2 yards, Inside Screen: 6.1 yards, Outside Screen: 7.1 yards, Seat Cushion: 3.6 yards, 79.2 sq ft, Back Cushion: 8.7 yards, 191.4 sq ft, Contrasting Pulls on Articulating Back Cushion: 0.5 yards, 1.1 sq ft

► Specification Information, continued on next page

# Lagunitas Lounge System 3-Seat Lounges

DESIGN TOAN NGUYEN

► Specification Information, continued from previous page

## Specification Information

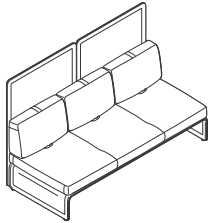

**Three articulating backs**  
**Overall:** 76<sup>7</sup>/<sub>8</sub>"W x 34"D x 50"H  
**Inside (Lounge):** 76<sup>7</sup>/<sub>8</sub>"W x 22<sup>1</sup>/<sub>2</sub>"D  
**Inside (Task):** 76<sup>7</sup>/<sub>8</sub>"W x 17<sup>3</sup>/<sub>4</sub>"D  
**Seat:** 16"H

Style Number      Base Price

### 3-Seat Lounge with High-Back Screen

COLAGLH31      \$6569

#### Fabric Upcharges

	Fabric Grades:										Leather Grades:	
	6	7	8	9	10	11	12	13	14	C	E	
Articulating Back Pulls (if top and bottom contrasting pulls are selected)	+\$ 25	+\$ 30	+\$ 41	+\$ 68	+\$ 84	+\$ 103	+\$ 118	+\$ 141	+\$ 177	+\$ 254	+\$ 298	
Seat Cushion	+\$ 188	+\$225	+\$286	+\$473	+\$ 594	+\$ 734	+\$ 833	+\$1007	+\$1246	+\$1801	+\$2118	
Back Cushion	+\$ 288	+\$344	+\$440	+\$724	+\$ 907	+\$1120	+\$1272	+\$1676	+\$1906	+\$2751	+\$3233	
Inside Screen	+\$ 277	+\$330	+\$419	+\$691	+\$ 866	+\$1071	+\$1213	+\$1467	+\$1818	N.A.	N.A.	
Outside Screen	+\$ 347	+\$416	+\$530	+\$876	+\$1096	+\$1360	+\$1677	+\$1857	+\$2543	N.A.	N.A.	

*Tip: Articulating back pull fabric upcharges only apply when contrasting pulls are selected.*

**Three Articulating Backs:** Seat Deck: 3.6 yards, Inside Screen: 3.2 yards, Outside Screen: 3.7 yards, Seat Cushion: 3.6 yards, 79.2 sq ft, Back Cushion: 5.5 yards, 121 sq ft, Contrasting Pulls on Articulating Back Cushions: 0.5 yards, 3.3 sq ft

► Specification Information, continued on next page

Lounge Seating

# Lagunitas Lounge System 3-Seat Lounges *continued*

DESIGN TOAN NGUYEN

► Specification Information, continued from previous page

## Specification Information

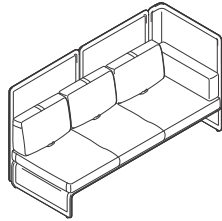

**Three articulating backs**  
Overall: 85"W x 34½"D x 50"H  
Seat: 16"H

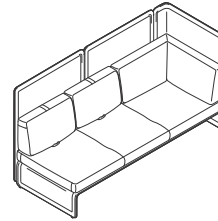

**Two articulating backs with one corner cushion**  
Overall: 85"W x 34½"D x 50"H  
Seat: 16"H

Style Number      Base Price

### 3-Seat Lounge with High-Back Screen and One Side Screen

COLAGLH32      \$7824

#### Fabric Upcharges

	Fabric Grades:									Leather Grades:	
	6	7	8	9	10	11	12	13	14	C	E
Articulating Back Pulls (if top and bottom contrasting pulls are selected)	+\$ 25	+\$ 30	+\$ 41	+\$ 68	+\$ 84	+\$ 103	+\$ 118	+\$ 141	+\$ 177	+\$ 254	+\$ 298
Seat Cushion	+\$180	+\$ 214	+\$ 269	+\$ 447	+\$ 564	+\$ 695	+\$ 786	+\$ 950	+\$ 1177	+\$1701	+\$1999
Back Cushion	+\$341	+\$406	+\$ 517	+\$ 856	+\$1075	+\$1327	+\$1504	+\$ 1816	+\$2252	+\$3251	+\$3822
Inside Screen	+\$332	+\$398	+\$ 511	+\$ 843	+\$1056	+\$1306	+\$ 1481	+\$1786	+\$2215	N.A.	N.A.
Outside Screen	+\$428	+\$514	+\$650	+\$1081	+\$1356	+\$1673	+\$1895	+\$2292	+\$2839	N.A.	N.A.

*Tip: Articulating back pull fabric upcharges only apply when contrasting pulls are selected.*

**Three Articulating Backs:** Arm: 0, Seat Deck: 2.3 yards, Inside Screen: 4.6 yards, Outside Screen: 5.4 yards, Seat Cushion: 3.4 yards, 74.8 sq ft, Back Cushion: 6.5 yards, 143 sq ft, Contrasting Pulls on Articulating Back Cushions: 0.5 yards, 3.3 sq ft  
**Two Articulating Backs with One Corner Cushion:** Arm: 0, Seat Deck: 2.3 yards, Inside Screen: 4.6 yards, Outside Screen: 5.4 yards, Seat Cushion: 3.4 yards, 74.8 sq ft, Back Cushion: 6.5 yards, 143 sq ft, Contrasting Pulls on Articulating Back Cushions: 0.5 yards, 2.2 sq ft

► Specification Information, continued on next page



# Lagunitas Lounge System 3-Seat Lounges

DESIGN TOAN NGUYEN

► Specification Information, continued from previous page

## Specification Information

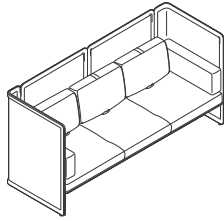

**Three articulating backs**  
**Overall:** 93<sup>3</sup>/<sub>8</sub>"W x 34"D x 50"H  
**Seat:** 16"H

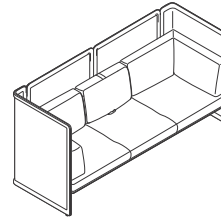

**One articulating back and two corner cushions**  
**Overall:** 93<sup>3</sup>/<sub>8</sub>"W x 34"D x 32<sup>3</sup>/<sub>8</sub>"H  
**Seat:** 16"H

Style Number      Base Price

### 3-Seat Lounge with High-Back Screen and Two Side Screens

COLAGLH33      \$9081

#### Fabric Upcharges

	Fabric Grades:										Leather Grades:	
	6	7	8	9	10	11	12	13	14	C	E	
Articulating Back Pulls (if top and bottom contrasting pulls are selected)	+\$ 25	+\$ 30	+\$ 41	+\$ 68	+\$ 84	+\$ 103	+\$ 118	+\$ 141	+\$ 177	+\$ 254	+\$298	
Seat Cushion	+\$188	+\$225	+\$286	+\$ 473	+\$ 594	+\$ 734	+\$ 833	+\$1007	+\$1246	+\$1801	+\$2118	
Back Cushion	+\$454	+\$544	+\$692	+\$1146	+\$1436	+\$1776	+\$2012	+\$2427	+\$3012	+\$4350	+\$5114	
Inside Screen	+\$392	+\$467	+\$594	+\$ 981	+\$1230	+\$1519	+\$1722	+\$2079	+\$2577	N.A.	N.A.	
Outside Screen	+\$503	+\$595	+\$ 761	+\$1255	+\$1579	+\$1949	+\$2208	+\$2668	+\$3308	N.A.	N.A.	

*Tip: Articulating back pull fabric upcharges only apply when contrasting pulls are selected.*

**Three Articulating Backs:** Arm: 0, Seat Deck: 2 yards, Inside Screen: 6.1 yards, Outside Screen: 7.1 yards, Seat Cushion: 3.6 yards, 79.2 sq ft, Back Cushion: 8.7 yards, 191.4 sq ft, Contrasting Pulls on Articulating Back Cushions: 0.5 yards, 3.3 sq ft

**One Articulating Back and Two Corner Cushions:** Arm: 0, Seat Deck: 2 yards, Inside Screen: 6.1 yards, Outside Screen: 7.1 yards, Seat Cushion: 3.6 yards, 79.2 sq ft, Back Cushion: 8.7 yards, 191.4 sq ft, Contrasting Pulls on Articulating Back Cushion: 0.5 yards, 1.1 sq ft

# Lagunitas Lounge System 2-Seat Chaises

DESIGN TOAN NGUYEN

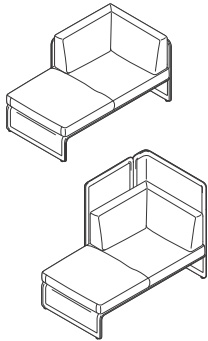

► Need help?  
Product details, see *Coalesse Seating and Outdoor Specification Guide*

### Standard Includes

- Screen: grade 1 knit
- Seat deck: grade 1 knit to match screen
- Non-contrasting seat cushion, articulating back cushion and pulls, back corner cushion, and end arm cushion, if selected: fabric or leather
- Bracket: paint
- Six adjustable glides
- Ships assembled

### Required to Specify

- 1 Style number
  - 2 Handedness (see below under Required Selections)
  - 3 Knit color number for screen
  - 4 Fabric or leather color number for non-contrasting seat cushion, articulating back cushion and pull, back corner cushion, and end arm cushion, if selected
  - 5 Paint color number for bracket:  
4141 Platinum Matte  
4710 Low Gloss Black
  - 6 Options, if selected (see below)
- See *Surface Materials*, page 196

	Required Selections	Price	Required to Specify
<b>Handedness</b>	• Left-hand, 2-seat chaises only (seated position)	No cost	Specify with <i>left-hand configuration</i> .
	• Right-hand, 2-seat chaises only (seated position)	No cost	Specify with <i>right-hand configuration</i> .

	Options	Price	Required to Specify
<b>Surface Materials</b>	<b>Fabric screen</b>		
	• 2-seat chaise with one low-back screen and one right- or one left-hand screen	+\$316	Specify with <i>screen type fabric</i> .
	• 2-seat chaise with one high-back screen and one right- or one left-hand screen	+\$386	Specify with <i>screen type fabric</i> .
	• Contrasting fabric for screen	+\$167	Specify with <i>contrasting fabric</i> and select fabric or leather color number.
	• Contrasting fabric for cushion	+\$167	Specify with <i>contrasting fabric</i> and select fabric or leather color number.
	• Contrasting fabric for articulating back pulls	+\$167	Specify with <i>contrasting fabric</i> and select fabric or leather color number. ► See <i>Surface Materials</i> , page 196
	• Fabric upcharges	Prices at right	Specify fabric color number.
	<b>Knit screen</b>		
	• Grade 1 knit screen	No cost	Specify with <i>screen type knit</i> and select knit color number.
	• Grade 2 knit screen		
– 2-seat chaise with one low-back screen and one right- or one left-hand screen	+\$491	Specify with <i>screen type knit</i> and select knit color number.	
– 2-seat chaise with one high-back screen and one right- or one left-hand screen	+\$566	Specify with <i>screen type knit</i> and select knit color number.	
<b>Acrylic backer</b>			
• 2-seat chaise with one low-back screen and one right- or one left-hand screen	+\$ 94	Specify with <i>acrylic backer</i> .	
• 2-seat chaise with one high-back screen and one right- or one left-hand screen	+\$140	Specify with <i>acrylic backer</i> . ► See <i>Surface Materials</i> , page 196	
• COM	+\$206	Specify with <i>COM</i> and select fabric color number. ► See <i>Surface Materials</i> , page 198	
• COL	+\$376	Specify with <i>COL</i> and select leather color number. ► See <i>Surface Materials</i> , page 198	

► Options, continued on next page

*Tip: If contrasting screen is selected, it is required to specify whether seat deck finish will match inner screen or outer screen.*

*Tip: Contrasting fabric for articulating back pull upcharge is applied one time per style number.*

*Tip: For Customer's Own Material or Leather, see necessary requirements, important processing instructions and ordering information.*  
► See *Coalesse Surface Materials Reference Guide*.

*Tip: For any portion of the product that requires a COM, the additional upcharge is a one time charge per product.*

*Tip: For any portion of the product that requires a COL, the additional upcharge is a one time charge per product.*

*Tip: Must combine seat deck and list screen pricing choice (knit grade 1, knit grade 2, or fabric) from either non-contrasting or contrasting pricing list with seat and back cushion list pricing (fabric and leather) from either non-contrasting or contrasting pricing list to obtain completed list price.*

# Lagunitas Lounge System 2-Seat Chaises

DESIGN TOAN NGUYEN

*Tip: For each USB port specified, there is one USB per port.*

► Options, continued from previous page

Options	Price	Required to Specify
<b>Power/USB Configuration</b>		
• One power module: two power in 4710 Black paint	+\$ 418	Specify with one power module, with two power.
• One power module: one USB A+C 20W /one power in 4710 Black paint	+\$ 555	Specify with one power module, with one power/one USB A+C 20W.
• Two power modules: two power each in 4710 Black paint	+\$ 836	Specify with two power modules, with two power.
• Two power modules: one USB A+C 20W /one power each in 4710 Black paint	+\$1110	Specify with two power modules, with one power/one USB A+C 20W.

<b>Related Products</b>	<ul style="list-style-type: none"> <li>Lagunitas tables</li> <li>Lounge</li> <li>Bench</li> </ul>	<ul style="list-style-type: none"> <li>► See GSA Volume 5b Specification Guide.</li> <li>► Pages 88–98</li> <li>► Page 114</li> </ul>
-------------------------	---	---

Specification Information

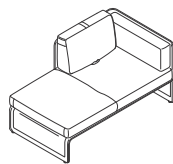

**One articulating back**  
Overall: 59<sup>3</sup>/<sub>8</sub>"W x 34"D x 32<sup>3</sup>/<sub>8</sub>"H  
Seat: 16"H

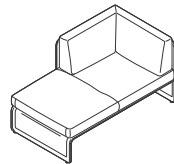

**One corner cushion**  
Overall: 59<sup>3</sup>/<sub>8</sub>"W x 34"D x 32<sup>3</sup>/<sub>8</sub>"H  
Seat: 16"H

Style Number	Base Price
--------------	------------

*Tip: Handedness is determined while in the seated position. Illustration above shows left-hand chaise.*

## 2-Seat Chaise with Low-Back Screen and One Side Screen

COLAGCL2	\$4022
----------	--------

Fabric Upcharges

	Fabric Grades:										Leather Grades:	
	6	7	8	9	10	11	12	13	14	C	E	
Articulating Back Pulls (if contrasting pull selected)	+\$ 25	+\$ 30	+\$ 41	+\$ 68	+\$ 84	+\$ 103	+\$ 118	+\$ 141	+\$ 177	+\$ 254	+\$ 298	
Seat Cushion	+\$ 157	+\$ 187	+\$236	+\$393	+\$494	+\$ 610	+\$ 691	+\$ 834	+\$1034	+\$1491	+\$1753	
Back Cushion	+\$ 151	+\$ 182	+\$ 231	+\$383	+\$478	+\$ 592	+\$ 669	+\$ 808	+\$1000	+\$1449	+\$1704	
Inside Screen	+\$ 217	+\$256	+\$328	+\$539	+\$678	+\$ 839	+\$ 950	+\$1147	+\$ 1422	N.A.	N.A.	
Outside Screen	+\$290	+\$346	+\$440	+\$727	+\$ 911	+\$1123	+\$1273	+\$1678	+\$ 1908	N.A.	N.A.	

*Tip: Articulating back pull fabric upcharges only apply when contrasting pull is selected.*

**One Articulating Back:** Arm: 0, Seat Deck: 2.7 yards, Inside Screen: 2.7 yards, Outside Screen: 3.2 yards, Seat Cushion: 3 yards, 66 sq ft, Back Cushion: 2.9 yards, 63.8 sq ft

**One Corner Cushion:** Arm: 0, Seat Deck: 2.7 yards, Inside Screen: 2.7 yards, Outside Screen: 3.2 yards, Seat Cushion: 3 yards, 66 sq ft, Back Cushion: 2.9 yards, 63.8 sq ft

► Specification Information, continued on next page

Lounge Seating

# Lagunitas Lounge System 2-Seat Chaises *continued*

DESIGN TOAN NGUYEN

► Specification Information, continued from previous page

## Specification Information

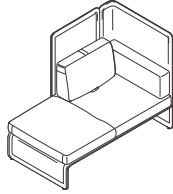

**One articulating back**  
**Overall:** 59<sup>3</sup>/<sub>8</sub>"W x 34"D x 50"H  
**Seat:** 16"H

*Tip: Handedness is determined while in the seated position. Illustration above shows left-hand chaise.*

Style Number	Base Price
--------------	------------

### 2-Seat Chaise with High-Back Screen and One Side Screen

COLAGCH2	\$4937
----------	--------

#### Fabric Upcharges

	Fabric Grades:								Leather Grades:		
	6	7	8	9	10	11	12	13	14	C	E
Articulating Back Pulls (if contrasting pull selected)	+\$ 25	+\$ 30	+\$ 41	+\$ 68	+\$ 84	+\$ 103	+\$ 118	+\$ 141	+\$ 177	+\$ 254	+\$ 298
Seat Cushion	+\$ 157	+\$ 187	+\$236	+\$393	+\$494	+\$ 610	+\$ 691	+\$ 834	+\$1034	+\$1491	+\$1753
Back Cushion	+\$ 151	+\$ 182	+\$231	+\$383	+\$478	+\$ 592	+\$ 669	+\$ 808	+\$1000	+\$1449	+\$1704
Inside Screen	+\$ 218	+\$258	+\$330	+\$545	+\$686	+\$ 847	+\$ 959	+\$1159	+\$1436	N.A.	N.A.
Outside Screen	+\$293	+\$348	+\$443	+\$732	+\$ 917	+\$1134	+\$1283	+\$1551	+\$1923	N.A.	N.A.

*Tip: Articulating back pull fabric upcharges only apply when contrasting pull is selected.*

**One Articulating Back:** Arm: 0, Seat Deck: 2.7 yards, Inside Screen: 2.7 yards, Outside Screen: 3.2 yards, Seat Cushion: 3 yards, 66 sq ft, Back Cushion: 2.9 yards, 63.8 sq ft

**One Corner Cushion:** Arm: 0, Seat Deck: 2.7 yards, Inside Screen: 2.7 yards, Outside Screen: 3.2 yards, Seat Cushion: 3 yards, 66 sq ft, Back Cushion: 2.9 yards, 63.8 sq ft

Coalesse SIN 33721

# Lagunitas Lounge System 2-Seat Chaises

DESIGN TOAN NGUYEN

# Lagunitas Lounge System 3-Seat Chaises

DESIGN TOAN NGUYEN

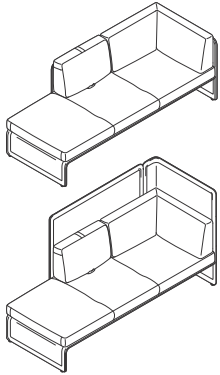

► Need help?  
Product details, see *Coalesse Seating and Outdoor Specification Guide*

### Standard Includes

- Screen: grade 1 knit
- Seat deck: grade 1 knit to match screen
- Non-contrasting seat cushion, articulating back cushion and pulls, back corner cushion, and end arm cushion, if selected: fabric or leather
- Bracket: paint
- Six adjustable glides
- Ships assembled

### Required to Specify

- 1 Style number
  - 2 Handedness (see below under Required Selections)
  - 3 Knit color number for screen
  - 4 Fabric or leather color number for non-contrasting seat cushion, articulating back cushion and pull, back corner cushion, and end arm cushion, if selected
  - 5 Paint color number for bracket:  
4141 Platinum Matte  
4710 Low Gloss Black
  - 6 Options, if selected (see below)
- See *Surface Materials*, page 196

	Required Selections	Price	Required to Specify
<b>Handedness</b>	• Left-hand, 3-seat chaises only (seated position)	No cost	Specify with <i>left-hand configuration</i> .
	• Right-hand, 3-seat chaises only (seated position)	No cost	Specify with <i>right-hand configuration</i> .

	Options	Price	Required to Specify
<b>Surface Materials</b>	<b>Fabric screen</b>		
	• 3-seat chaise with one low-back screen and one right- or one left-hand screen	+\$418	Specify with <i>screen type fabric</i> .
	• 3-seat chaise with one high-back screen and one right- or one left-hand screen	+\$456	Specify with <i>screen type fabric</i> .
	• Contrasting fabric for screen	+\$167	Specify with <i>contrasting fabric</i> and select fabric or leather color number.
	• Contrasting fabric for cushion	+\$167	Specify with <i>contrasting fabric</i> and select fabric or leather color number.
	• Contrasting fabric for articulating back pulls	+\$167	Specify with <i>contrasting fabric</i> and select fabric or leather color number. ► See <i>Surface Materials</i> , page 196
	• Fabric upcharges	Prices at right	Specify fabric color number.
	<b>Knit screen</b>		
	• Grade 1 knit screen	No cost	Specify with <i>screen type knit</i> and select knit color number.
	• Grade 2 knit screen		
– 3-seat chaise with one low-back screen and one right- or one left-hand screen	+\$593	Specify with <i>screen type knit</i> and select knit color number.	
– 3-seat chaise with one high-back screen and one right- or one left-hand screen	+\$664	Specify with <i>screen type knit</i> and select knit color number.	
<b>Acrylic backer</b>			
• 3-seat chaise with one low-back screen and one right- or one left-hand screen	+\$122	Specify with <i>acrylic backer</i> .	
• 3-seat chaise with one high-back screen and one right- or one left-hand screen	+\$196	Specify with <i>acrylic backer</i> . ► See <i>Surface Materials</i> , page 196	
• COM	+\$206	Specify with <i>COM</i> and select fabric color number. ► See <i>Surface Materials</i> , page 198	
• COL	+\$376	Specify with <i>COL</i> and select leather color number. ► See <i>Surface Materials</i> , page 198	

► Options, continued on next page

*Tip: If contrasting screen is selected, it is required to specify whether seat deck finish will match inner screen or outer screen.*

*Tip: Contrasting fabric for articulating back pull upcharge is applied one time per style number.*

*Tip: For Customer's Own Material or Leather, see necessary requirements, important processing instructions and ordering information.*  
► See *Coalesse Surface Materials Reference Guide*.

*Tip: For any portion of the product that requires a COM, the additional upcharge is a one time charge per product.*

*Tip: For any portion of the product that requires a COL, the additional upcharge is a one time charge per product.*

*Tip: Must combine seat deck and list screen pricing choice (knit grade 1, knit grade 2, or fabric) from either non-contrasting or contrasting pricing list with seat and back cushion list pricing (fabric and leather) from either non-contrasting or contrasting pricing list to obtain completed list price.*

# Lagunitas Lounge System 3-Seat Chaises

DESIGN TOAN NGUYEN

*Tip: For each USB port specified, there is one USB per port.*

► Options, continued from previous page

Options	Price	Required to Specify
<b>Power/USB Configuration</b>		
• One power module: two power in 4710 Black paint	+\$ 418	Specify with one power module, with two power.
• One power module: one USB A+C 20W /one power in 4710 Black paint	+\$ 555	Specify with one power module, with one power/one USB A+C 20W.
• Two power modules: two power each in 4710 Black paint	+\$ 836	Specify with two power modules, with two power.
• Two power modules: one USB A+C 20W /one power each in 4710 Black paint	+\$1110	Specify with two power modules, with one power/one USB A+C 20W.

<b>Related Products</b>	<ul style="list-style-type: none"> <li>Lagunitas tables</li> <li>Lounge</li> <li>Bench</li> </ul>	<ul style="list-style-type: none"> <li>► See GSA Volume 5b Specification Guide.</li> <li>► Pages 88–98</li> <li>► Page 114</li> </ul>
-------------------------	---	---

## Specification Information

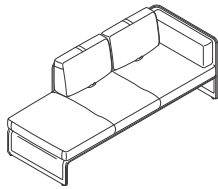

**Two articulating backs**  
Overall: 85"W x 34"D x 32<sup>3</sup>/<sub>8</sub>"H  
Seat: 16"H

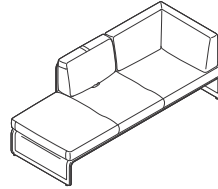

**One articulating back and one corner cushion**  
Overall: 85"W x 34"D x 32<sup>3</sup>/<sub>8</sub>"H  
Seat: 16"H

Style Number	Base Price
--------------	------------

## 3-Seat Chaise with Low-Back Screen and One Side Screen

<b>COLAGCL3</b>	\$5292
-----------------	--------

### Fabric Upcharges

	Fabric Grades:										Leather Grades:	
	6	7	8	9	10	11	12	13	14	C	E	
Articulating Back Pulls (if contrasting pull selected)	+\$ 25	+\$ 30	+\$ 41	+\$ 68	+\$ 84	+\$ 103	+\$ 118	+\$ 141	+\$ 177	+\$ 254	+\$ 298	
Seat Cushion	+\$ 215	+\$256	+\$326	+\$538	+\$ 674	+\$ 833	+\$ 942	+\$ 1141	+\$ 1413	+\$2039	+\$2399	
Back Cushion	+\$244	+\$294	+\$373	+\$ 619	+\$ 775	+\$ 959	+\$1087	+\$ 1311	+\$ 1628	+\$2352	+\$2762	
Inside Screen	+\$275	+\$328	+\$ 417	+\$690	+\$ 866	+\$1070	+\$1213	+\$1466	+\$ 1817	N.A.	N.A.	
Outside Screen	+\$349	+\$ 417	+\$529	+\$874	+\$1098	+\$1356	+\$1677	+\$1857	+\$2299	N.A.	N.A.	

**Two Articulating Backs:** Arm: 0, Seat Deck: 3.7 yards, Inside Screen: 3.5 yards, Outside Screen: 3.9 yards, Seat Cushion: 4.1 yards, 90.2 sq ft, Back Cushion: 4.7 yards, 103.4 sq ft

**One Articulating Back and One Corner Cushion:** Arm: 0, Seat Deck: 3.7 yards, Inside Screen: 3.5 yards, Outside Screen: 3.9 yards, Seat Cushion: 4.1 yards, 90.2 sq ft, Back Cushion: 4.7 yards, 103.4 sq ft

► Specification Information, continued on next page

*Tip: Handedness is determined while in the seated position. Illustration above shows left-hand chaise.*

*Tip: Articulating back pull fabric upcharges only apply when contrasting pull is selected.*

# Lagunitas Lounge System 3-Seat Chaises *continued*

DESIGN TOAN NGUYEN

► Specification Information, continued from previous page

## Specification Information

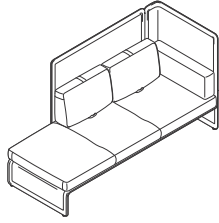

**Two articulating backs**  
Overall: 85"W x 34"D x 50"H  
Seat: 16"H

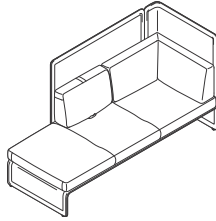

**One articulating back and one corner cushion**  
Overall: 85"W x 34"D x 50"H  
Seat: 16"H

Style Number                      Base Price

### 3-Seat Chaise with High-Back Screen and One Side Screen

COLAGCH3                      \$6208

#### Fabric Upcharges

	Fabric Grades:									Leather Grades:	
	6	7	8	9	10	11	12	13	14	C	E
Articulating Back Pulls (if contrasting pull selected)	+\$ 25	+\$ 30	+\$ 41	+\$ 68	+\$ 84	+\$ 103	+\$ 118	+\$ 141	+\$ 177	+\$ 254	+\$ 298
Seat Cushion	+\$ 215	+\$256	+\$326	+\$538	+\$ 674	+\$ 833	+\$ 942	+\$ 1141	+\$ 1413	+\$2039	+\$2399
Back Cushion	+\$244	+\$294	+\$373	+\$ 619	+\$ 775	+\$ 959	+\$1087	+\$ 1311	+\$ 1628	+\$2352	+\$2762
Inside Screen	+\$275	+\$328	+\$ 417	+\$690	+\$ 866	+\$1070	+\$1213	+\$1466	+\$ 1817	N.A.	N.A.
Outside Screen	+\$349	+\$ 417	+\$529	+\$874	+\$1098	+\$1356	+\$1677	+\$1857	+\$2299	N.A.	N.A.

**Two Articulating Backs:** Arm: 0, Seat Deck: 3.7 yards, Inside Screen: 3.5 yards, Outside Screen: 3.9 yards, Seat Cushion: 4.1 yards, 90.2 sq ft, Back Cushion: 4.7 yards, 103.4 sq ft

**One Articulating Back and One Corner Cushion:** Arm: 0, Seat Deck: 3.7 yards, Inside Screen: 3.5 yards, Outside Screen: 3.9 yards, Seat Cushion: 4.1 yards, 90.2 sq ft, Back Cushion: 4.7 yards, 103.4 sq ft

*Tip: Handedness is determined while in the seated position. Illustration above shows left-hand chaise.*

*Tip: Articulating back pull fabric upcharges only apply when contrasting pull is selected.*



Coalesse SIN 33721

# Lagunitas Lounge System 3-Seat Chaises

DESIGN TOAN NGUYEN

# Lagunitas Lounge System Benches

DESIGN TOAN NGUYEN

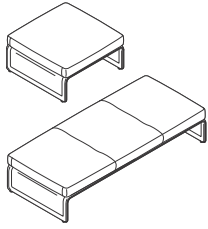

Standard Includes		Required to Specify
<ul style="list-style-type: none"> <li>▶ Need help? Product details, see <i>Coalesse Seating and Outdoor Specification Guide</i></li> </ul>	<ul style="list-style-type: none"> <li>• Seat deck: grade 1 knit</li> <li>• Seat cushion: fabric or leather</li> <li>• Four adjustable glides</li> <li>• Ships assembled</li> </ul>	<ol style="list-style-type: none"> <li>1 Style number</li> <li>2 Knit or fabric color number for seat deck</li> <li>3 Fabric or leather color number for seat cushion</li> <li>4 Options, if selected (see below)</li> </ol> <ul style="list-style-type: none"> <li>▶ See <i>Surface Materials</i>, page 196</li> </ul>

Options	Price	Required to Specify
<b>Surface Materials</b> <ul style="list-style-type: none"> <li>• Acrylic backer                             <ul style="list-style-type: none"> <li>• 1-seat bench cushion +\$ 22</li> <li>• 2-seat bench cushion +\$ 29</li> <li>• 3-seat bench cushion +\$ 40</li> </ul> </li> </ul>		Specify with acrylic backer. Specify with acrylic backer. Specify with acrylic backer. ▶ See <i>Surface Materials</i> , page 196
<ul style="list-style-type: none"> <li>• Fabric seat deck</li> </ul>	Prices at right	Specify with fabric seat deck and select fabric color number.
<b>Knit seat deck</b> <ul style="list-style-type: none"> <li>• Grade 1 knit seat deck</li> </ul>	No cost	Specify with screen type knit and select fabric color number.
<ul style="list-style-type: none"> <li>• Grade 2 knit seat deck                             <ul style="list-style-type: none"> <li>– 1-seat bench +\$ 105</li> <li>– 2-seat bench +\$ 141</li> <li>– 3-seat bench +\$ 177</li> </ul> </li> </ul>		Specify with screen type knit and select fabric color number. Specify with screen type knit and select fabric color number. Specify with screen type knit and select fabric color number.
<ul style="list-style-type: none"> <li>• COM</li> </ul>	+\$206	Specify with COM and select fabric color number. ▶ See <i>Surface Materials</i> , page 198
<ul style="list-style-type: none"> <li>• COL</li> </ul>	+\$375	Specify with COL and select leather color number. ▶ See <i>Surface Materials</i> , page 198

Tip: For Customer's Own Material or Leather, see necessary requirements, important processing instructions and ordering information.  
▶ See *Coalesse Surface Materials Reference Guide*.

Tip: For any portion of the product that requires a COM, the additional upcharge is a one time charge per product.

Tip: For any portion of the product that requires a COL, the additional upcharge is a one time charge per product.

Tip: Must combine seat deck and list screen pricing choice (knit grade 1, knit grade 2, or fabric) from either non-contrasting or contrasting pricing list with seat and back cushion list pricing (fabric and leather) from either non-contrasting or contrasting pricing list to obtain completed list price.

<b>Power/USB Configuration</b> <ul style="list-style-type: none"> <li>• 1-seat benches                             <ul style="list-style-type: none"> <li>• One power module: two power in 4710 Black paint +\$ 418</li> <li>• One power module: one USB A+C 20W/ one power in 4710 Black paint +\$555</li> </ul> </li> </ul>		Specify with one power module, with two power. Specify with one power module, with one power/one USB A+C 20W.
<ul style="list-style-type: none"> <li>• 2- and 3-seat benches                             <ul style="list-style-type: none"> <li>• Two power modules: two power each in 4710 Black paint +\$836</li> <li>• Two power modules: one USB A+C 20W/ one power each in 4710 Black paint +\$1110</li> </ul> </li> </ul>		Specify with two power modules, with two power. Specify with two power modules, with one power/one USB A+C 20W.
<b>Related Products</b> <ul style="list-style-type: none"> <li>• Lagunitas tables</li> <li>• Lounge</li> <li>• Chaise</li> </ul>		▶ See <i>GSA Volume 5b Specification Guide</i> . ▶ Pages 88–98 ▶ Pages 106–110

# Lagunitas Lounge System Benches

DESIGN TOAN NGUYEN

**Specification Information**

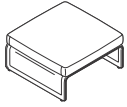

**Overall:** 32¾"W x 32¾"D x 16"H  
**Seat Deck:** 2.8 yards  
**Seat Cushion:** 2.6 yards, 57.2 sq ft

Style Number	Base Price
--------------	------------

## 1-Seat Bench

COLAGB1	\$1423
---------	--------

**Fabric Upcharges**

	Fabric Grades:								Leather Grades:		
	6	7	8	9	10	11	12	13	14	C	E
Seat Deck	+\$347	+\$384	+\$454	+\$655	+\$785	+\$937	+\$1042	+\$1230	+\$1493	N.A.	N.A.
Seat Cushion	+\$ 134	+\$164	+\$208	+\$343	+\$431	+\$530	+\$ 601	+\$ 727	+\$ 899	+\$1301	+\$1528

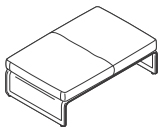

**Overall:** 51¼"W x 32¾"D x 16"H  
**Seat Deck:** 3.1 yards  
**Seat Cushion:** 3.2 yards, 70.4 sq ft

## 2-Seat Bench

COLAGB2	\$1996
---------	--------

**Fabric Upcharges**

	Fabric Grades:								Leather Grades:		
	6	7	8	9	10	11	12	13	14	C	E
Seat Deck	+\$360	+\$403	+\$473	+\$691	+\$836	+\$999	+\$1111	+\$1314	+\$1595	N.A.	N.A.
Seat Cushion	+\$ 168	+\$202	+\$256	+\$420	+\$528	+\$655	+\$738	+\$ 894	+\$1109	+\$1601	+\$1880

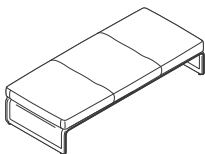

**Overall:** 76⅞"W x 32¾"D x 16"  
**Seat Deck:** 3.5 yards  
**Seat Cushion:** 4 yards, 88 sq ft

## 3-Seat Bench

COLAGB3	\$2565
---------	--------

**Fabric Upcharges**

	Fabric Grades:								Leather Grades:		
	6	7	8	9	10	11	12	13	14	C	E
Seat Deck	+\$ 382	+\$429	+\$510	+\$749	+\$901	+\$1081	+\$1205	+\$1426	+\$1734	N.A.	N.A.
Seat Cushion	+\$ 212	+\$252	+\$319	+\$527	+\$661	+\$ 820	+\$ 925	+\$1116	+\$1384	+\$2002	+\$2354

# Lagunitas Lounge System Accessories

DESIGN TOAN NGUYEN

## Lounge Booth Connector Screen



Screen: 38½"W x 50"H

*Tip: Lounge booth connector screen joins two high screen lounges, enclosing one side of booth.*

Standard Includes	Required to Specify
<ul style="list-style-type: none"> <li>▶ Need help? Product details, see <i>Coalesse Seating and Outdoor Specification Guide</i></li> <li>• Screen: grade 1 knit</li> <li>• Two bottom brackets: 4710 Low Gloss Black or 4141 Platinum Matte Paint</li> <li>• Two screen ganging alignment clips</li> </ul>	<ul style="list-style-type: none"> <li>1 Style number</li> <li>2 Knit color number for screen</li> <li>3 Paint color number for bracket</li> <li>4 Options, if selected (see below)</li> <li>▶ See <i>Surface Materials</i>, page 196</li> </ul>

Options	Price	Required to Specify
<b>Surface Materials</b>	<b>Knit screen</b>	
• Grade 1 knit screen	No cost	Specify with <i>screen type knit</i> and select knit color number.
• Grade 2 knit screen	+\$118	Specify with <i>screen type knit</i> and select knit color number.
• Fabric screen	+\$282	Specify with <i>screen type fabric</i> .
• Contrasting fabric	+\$167	Specify with <i>contrasting fabric</i> and select fabric color number.
• Fabric upcharges	Prices below	Specify fabric color number.
• COM	+\$206	Specify with <i>COM</i> and select fabric color number. ▶ See <i>Coalesse Surface Materials Reference Guide</i>

### Specification Information

Style Number	Base Price
COLAGLBS	\$970

Fabric Upcharges	Fabric Grades:								
	6	7	8	9	10	11	12	13	14
Inside Screen	+\$140	+\$170	+\$215	+\$353	+\$445	+\$549	+\$626	+\$ 756	+\$ 935
Outside Screen	+\$203	+\$244	+\$313	+\$515	+\$646	+\$796	+\$901	+\$1089	+\$1348

**Booth Connector Screen:** Inside Screen: 1.4 yards, Outside Screen: 1.6 yards

# Lagunitas Lounge System Accessories

DESIGN TOAN NGUYEN

## Alignment Connector

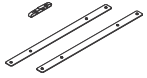

	Standard Includes	Required to Specify
▶ Need help? Product details, see <i>Coalesse Seating and Outdoor Specification Guide</i>	<ul style="list-style-type: none"><li>• Screen and seat deck connector package: pin, bracket, and hardware</li><li>• Ships ready to assemble</li></ul>	Style number

Related Products	
<ul style="list-style-type: none"><li>• Lounge</li><li>• Chaise</li></ul>	<ul style="list-style-type: none"><li>▶ Pages 88-98</li><li>▶ Pages 106-110</li></ul>

Specification Information	
Style Number	Price
COLAGCI	\$56

Lounge Seating

# Lagunitas Focus Nook

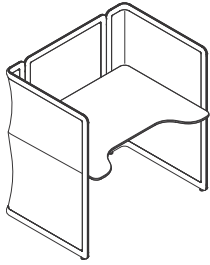

Tip: If a contrasting screen is specified, the fabric must be chosen from the same fabric family.

Tip: Grommets and power devices are specifiable on either the right or left side.

Tip: Power package must be specified when power and lighting grommet is specified.

Tip: Power simplex receptacles are tamper resistant.

Tip: When power module or power package in 4242 Milk Matte is specified, the 8' infeed cord will be white. When any other finish is specified, the infeed cord will be black.

Tip: Power/USB configuration upcharges are in addition to the power module or power package upcharge.

Standard Includes	Required to Specify
<ul style="list-style-type: none"> <li>Need help? Product details, see <i>Coalesse Seating and Outdoor Specification Guide</i></li> <li>Screen: grade 1 knit</li> <li>Worksurface:                             <ul style="list-style-type: none"> <li>Grade 1 laminate with 3 mm flat plastic edge</li> </ul> </li> <li>Brackets: 4710 Black Low Gloss Black paint</li> <li>Six adjustable glides</li> <li>Ships ready to assemble</li> </ul>	<ol style="list-style-type: none"> <li>Style number</li> <li>Knit color number for screen</li> <li>Laminate color number for table top</li> <li>Plastic edge color number for laminate top, if selected</li> <li>Options, if selected (see below)</li> </ol> <p>► See <i>Surface Materials</i>, page 196.</p>

Options	Price	Required to Specify
<b>Surface Materials</b> <ul style="list-style-type: none"> <li><b>Fabric screen</b> <ul style="list-style-type: none"> <li>Fabric screen +\$561</li> <li>Contrasting fabric for screen +\$167</li> </ul> </li> <li>Fabric upcharges Prices at right</li> </ul>		Specify with screen type fabric. Specify with contrasting fabric and select fabric color number. Specify fabric color number.
<ul style="list-style-type: none"> <li><b>Knit screen</b> <ul style="list-style-type: none"> <li>Grade 1 knit screen No cost</li> <li>Grade 2 knit screen +\$635</li> </ul> </li> <li>COM +\$206</li> </ul>		Specify with screen type knit and select knit color number. Specify with screen type knit and select knit color number. Specify with COM and select fabric color number. ► See <i>Surface Materials</i> , page 196.
<ul style="list-style-type: none"> <li><b>Worksurface</b> <ul style="list-style-type: none"> <li>Grade 2 laminate Prices at right</li> <li>Grade 3 laminate Prices at right</li> <li>Group 1 composite veneer Prices at right</li> <li>Group 2 composite veneer Prices at right</li> <li>Grade 1 wood veneer Prices at right</li> <li>Grade 2 wood veneer Prices at right</li> <li>Stain-to-Match No cost</li> </ul> </li> </ul>		Specify with Grade 2 laminate and select laminate color number. Specify with Grade 3 laminate and select laminate color number. Specify with Grade 1 composite veneer and select composite veneer color number. Specify with Grade 2 composite veneer and select composite veneer color number. Specify with Grade 1 wood veneer and select wood color number. Specify with Grade 2 wood veneer and select wood color number. Specify with Stain-to-Match. ► See <i>Surface Materials</i> , page 196.
<b>2" Light Grommet</b> <ul style="list-style-type: none"> <li>2" light grommet +\$ 30</li> </ul>		Specify with 2" grommet and select color number.
<b>Power/USB Configuration</b> <ul style="list-style-type: none"> <li><b>Power options (with three magnetic wire management brackets)</b> <ul style="list-style-type: none"> <li>Power module +\$349</li> <li>Power package (contains power module and below surface convenience plug for on-surface light) +\$544</li> </ul> </li> <li><b>Power/USB configurations</b> <ul style="list-style-type: none"> <li>Two TR simplex receptacles No cost</li> <li>One TR simplex receptacle and two USB A charging ports +\$137</li> <li>One TR simplex receptacle, one USB A charging port, and one USB C charging port +\$137</li> </ul> </li> </ul>		Specify with power module and select color number. Specify with power package and select color number. Specify with two power. Specify with one power, two USB A. Specify with one power, one USB A, one USB C.
<b>Cable Management Tray</b> <ul style="list-style-type: none"> <li>Cable management tray +\$166</li> </ul>		Specify with tray and select color number.
<b>Related Products</b> <ul style="list-style-type: none"> <li>Lagunitas lounge seating</li> <li>Lagunitas work and occasional tables</li> </ul>		► Page 88 ► See <i>GSA Volume 5b Specification Guide</i> .

# Lagunitas Focus Nook

## Specification Information

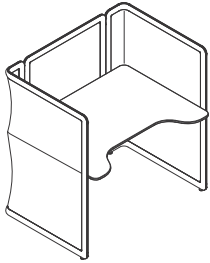

Knit Screen

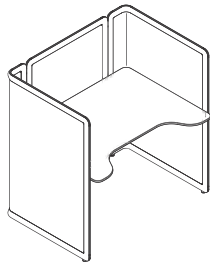

Fabric Screen

Style Number	Dimensions W D H			Base Prices					
				Flat Vinyl Edge on Laminate Top		Flat Wood Edge on Composite Veneer Top		Flat Wood Edge on Wood Top	
				Grade 1	Grades 2 and 3	Grade 1	Grades 2	Grade 1	Grades 2 and 3
COLAGFN	49 1/4"	37"	50"	\$3524	\$3698	\$4866	\$5170	\$4866	\$5170

### Fabric Upcharges

	Fabric Grades:								
	6	7	8	9	10	11	12	13	14
Inside Screen	+\$280	+\$332	+\$456	+\$703	+\$ 884	+\$1091	+\$1237	+\$1494	+\$1852
Outside Screen	+\$ 371	+\$443	+\$564	+\$930	+\$1165	+\$1438	+\$1631	+\$1969	+\$2437

Inside screen: 4.4 yds, Outside screen: 5.1 yds

Lounge Seating

# Passerelle Lounge

DESIGN STUDIO B

*Tip: Fabrics and leathers will appear loose with comfort wrinkles when upholstered.*

*Tip: Recommended leathers are Elmosoft Grade C and Elmorustical Grade E.*

*Tip: Special color match, consult Customer Service.*

*Tip: For Customer's Own Material or Leather, see necessary requirements, important processing instructions, and ordering information*  
 ▶ See *Coalesse Surface Materials Reference Guide*.

Standard Includes		Required to Specify	
▶ Need help? Product details, see <i>Coalesse Seating and Outdoor Specification Guide</i>	<ul style="list-style-type: none"> <li>• Frame: unibody construction with finger jointed plywood</li> <li>• Upholstery: multiple densities of polyurethane foam and polyester fiber on seat, back, and arms</li> <li>• Legs: solid maple with non-adjustable glides</li> </ul>	<ol style="list-style-type: none"> <li>1 Style number</li> <li>2 Number of fabrics if contrasting fabric style number is selected</li> <li>3 Fabric or leather color number for upholstery on seat, back, and arms</li> <li>4 Wood color number for legs</li> <li>5 Options, if selected (see below)</li> </ol> ▶ See <i>Surface Materials</i> , page 196	
Options		Price	Required to Specify
<b>Surface Materials</b>	<ul style="list-style-type: none"> <li>• Contrasting fabric</li> </ul> <hr/> <b>Acrylic backer</b> <ul style="list-style-type: none"> <li>• Lounge chair</li> <li>• 2-seat lounge</li> <li>• 3-seat lounge</li> <li>• Arm bolster</li> </ul>	+\$167 per fabric  +\$ 46 +\$ 64 +\$ 77 +\$ 9	Add suffix K to the style number and select fabric color number.  Specify with acrylic backer. Specify with acrylic backer. Specify with acrylic backer. Specify with acrylic backer. ▶ See <i>Surface Materials</i> , page 196
<b>Bolster/Pillow Attachment Rings</b>	<ul style="list-style-type: none"> <li>• Attachment rings for bolster/pillow attach to lounge attachment straps</li> </ul>	+\$ 90	Specify with attachment rings.
<b>Lounge Attachment Straps</b>	<ul style="list-style-type: none"> <li>• Attachment straps for lounge attach to bolster/pillow attachment rings</li> </ul>	No cost	Specify with attachment straps for left and right sides.
<b>Related Products</b>	<ul style="list-style-type: none"> <li>• Passerelle tables</li> </ul>		▶ See <i>GSA Volume 5b Specification Guide</i> .

## Specification Information

Style Number	Base Prices										Leather Grades:		
	Fabric Grades:										COL	C	E
	COM	6	7	8	9	10	11	12	13	14			

### Lounge Chair

440-WB	\$2261	\$2291	\$2344	\$2398	\$2496	\$2590	\$2831	\$3000	\$3049	\$3358	\$2522	\$5401	\$5892
COM/yds = 4, COL/sq ft = 88													

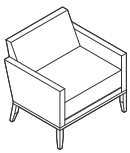

Overall: 27"D 30½"W 29"H  
 Inside: 19"D 26"W 17"H  
 Seat: 17½"H  
 Arm: 23"H

### 2-Seat Lounge

440-2WB	\$4053	\$4163	\$4256	\$4318	\$4460	\$4572	\$4912	\$5157	\$5200	\$5762	\$4321	\$8323	\$8865
COM/yds = 5½, COL/sq ft = 121													

▶ Specification Information, continued on next page

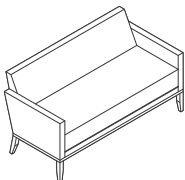

Overall: 27"D 56½"W 29"H  
 Inside: 19"D 52"W 17"H  
 Seat: 17½"H  
 Arm: 23"H



# Passerelle Lounge

DESIGN STUDIO B

► Specification Information, continued from previous page

## Specification Information

Style Number	Base Prices										Leather Grades:		
	Fabric Grades:										COL	C	E
	COM	6	7	8	9	10	11	12	13	14			

### 3-Seat Lounge

<b>440-3WB</b>	\$4525	\$4705	\$4817	\$4892	\$5071	\$5209	\$5639	\$5910	\$5989	\$6626	\$4786	\$9752	\$10,343
COM/yds = 6 <sup>3</sup> / <sub>4</sub> , COL/sq ft = 149													

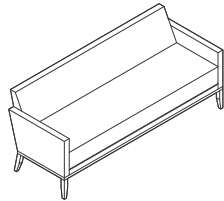

Overall: 27"D 72<sup>3</sup>/<sub>4</sub>"W 29"H  
 Inside: 19"D 68"W 17"H  
 Seat: 17<sup>1</sup>/<sub>2</sub>"H

Arm: 23"H



Overall: 17<sup>1</sup>/<sub>2</sub>"W 5<sup>3</sup>/<sub>4</sub>"Dia

### Arm Bolster

<b>440-B</b>	\$ 386	\$ 392	\$ 402	\$ 421	\$ 464	\$ 533	\$ 585	\$ 598	\$ 621	\$ 645	\$ 777	\$1180	\$ 1580
COM/yds = 1, COL/sq ft = 18													

Lounge Seating

# Passerelle Benches

DESIGN STUDIO B

*Tip: Fabrics and leathers will appear loose with comfort wrinkles when upholstered.*

*Tip: For plain upholstery option or contrasting textiles, contact Customer Service.*

*Tip: Recommended leathers are Elmosoft Grade C and Elmorustical Grade E.*

*Tip: Special color match, consult Customer Service.*

*Tip: For Customer's Own Material or Leather, see necessary requirements, important processing instructions, and ordering information*  
 ▶ See *Coalesse Surface Materials Reference Guide*.

Standard Includes		Required to Specify
▶ Need help? Product details, see <i>Coalesse Seating and Outdoor Specification Guide</i>	<ul style="list-style-type: none"> <li>• Frame: solid maple</li> <li>• Upholstery: multiple densities of polyurethane foam</li> <li>• Legs: solid maple with non-adjustable glides</li> <li>• Button detail: tufted and double needled</li> </ul>	1 Style number 2 Fabric or leather color number for upholstery on bench 3 Wood color number for legs 4 Options, if selected (see below) ▶ See <i>Surface Materials</i> , page 196

Options	Price	Required to Specify
<b>Surface Materials</b> <b>Acrylic backer</b>		
• 20"D x 60"W bench	+\$36	Specify with acrylic backer.
• 30"D x 60"W bench	+\$50	Specify with acrylic backer. ▶ See <i>Surface Materials</i> , page 196

Specification Information													
Style Number	Base Prices												
	Fabric Grades:												
	COM	6	7	8	9	10	11	12	13	14	Leather Grades:		
											COL	C	E

## Bench

<b>440-B3060WB</b>	\$2760	\$2776	\$2852	\$2893	\$2995	\$3070	\$3254	\$3411	\$3476	\$3848	\$3044	\$5941	\$6462
COM/yds = 4, COL/sq ft = 88													

<b>440-B2060WB</b>	\$2404	\$2415	\$2472	\$2493	\$2564	\$2636	\$2728	\$2855	\$2906	\$3235	\$2750	\$4732	\$5094
COM/yds = 2¾, COL/sq ft = 61													

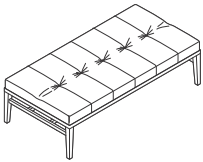

Overall: 30"D 60"W 17"H

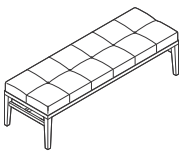

Overall: 20"D 60"W 17"H

Coalesse SIN 33721

# Passerelle Benches

DESIGN STUDIO B

# Switch

DESIGN E00S

*Tip: Fabrics and leathers will appear loose with comfort wrinkles when upholstered.*

*Tip: Due to seat conversion arms are 4 1/2"W. Lowered arm has weight limit of 100 lb.*

*Tip: Recommended leathers are Elmosoft Grade C and Elmorustical Grade E.*

*Tip: Loose cushions standard.*

*Tip: Arm bolsters must be specified separately.*

*Tip: Special color match, consult Customer Service.*

*Tip: For Customer's Own Material or Leather, see necessary requirements, important processing instructions, and ordering information*  
 ► See *Coalesse Surface Materials Reference Guide*.

*Tip: 391-4 two seat with extensions, when extended: Both arms = 96"W overall One arm = 84"W overall Arms not extended = 71"W overall (closed).*

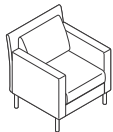

**Overall:** 29 1/2"D 28"W 32 1/2"H  
**Inside:** 19"D 20"W 17"H  
**Seat:** 17 1/2"H  
**Arm:** 26"H

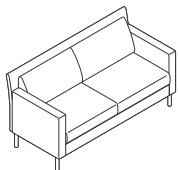

**Overall:** 24 1/2"D 62"W 33"H  
**Inside:** 19"D 54 1/2"W 33"H  
**Seat:** 19 1/2"H  
**Arm:** 26 1/4"H

## Standard Includes

- Need help? Product details, see *Coalesse Seating and Outdoor Specification Guide*
- Selected solid hardwood and wood veneer frame
- Two seat with extension: tubular steel frame with solid hardwood arms
  - Arms are 4.5" wide
- Upholstery: multiple densities of polyurethane foam and polyester fiber on seat back and arms
- Legs: matte chrome finish on steel
- Arm bolster, if selected: fabric or leather

## Required to Specify

- 1 Style number
  - 2 Number of fabrics if contrasting fabric style number is selected
  - 3 Fabric or leather color number for upholstery on seat, back, and arms, or arm bolsters, if selected
  - 4 Options, if selected (see below)
- See *Surface Materials*, page 196

## Options

Options	Price
Surface Materials	• Contrasting fabric +\$167 per fabric

## Required to Specify

Add suffix K to the style number and select fabric color number.

### Acrylic backer

• Lounge chair	+\$ 50
• 2-seat lounge	+\$103
• 3-seat lounge	+\$109
• 2-seat lounge with extensions	+\$123
• Arm bolster	+\$ 9

Specify with *acrylic backer*.  
 Specify with *acrylic backer*.  
 Specify with *acrylic backer*.  
 Specify with *acrylic backer*.  
 Specify with *acrylic backer*.  
 ► See *Surface Materials*, page 196

<b>Attachment Straps</b>	• 391 +\$179
	• 391-2 +\$358
	• 391-3 +\$537
	• 391-4 +\$358
	• Bolster +\$ 93

Specify with *attachment straps*.  
 Specify with *attachment straps*.  
 Specify with *attachment straps*.  
 Specify with *attachment straps*.  
 Specify with *attachment straps*.

**Related Products** • Switch tables

► See *GSA Volume 5b Specification Guide*.

## Specification Information

Style Number	Base Prices										Leather Grades:		
	Fabric Grades:										COL	C	E
	COM	6	7	8	9	10	11	12	13	14			

### Lounge Chair

391	\$3310	\$3317	\$3358	\$3426	\$3638	\$3771	\$3929	\$4039	\$4231	\$4501	\$3547	\$ 7015	\$ 7942
COM/yds = 4 1/2, COL/sq ft = 99													

### 2-Seat Lounge

391-2	\$5066	\$5212	\$5280	\$5397	\$5747	\$5971	\$6235	\$6417	\$6739	\$7190	\$5304	\$10,948	\$12,289
COM/yds = 7 1/2, COL/sq ft = 165													

► Specification Information, continued on next page

# Switch

DESIGN EOOS

► Specification Information, continued from previous page

## Specification Information

Style Number	Base Prices											Leather Grades:		
	Fabric Grades:											COL	C	E
	COM	6	7	8	9	10	11	12	13	14				

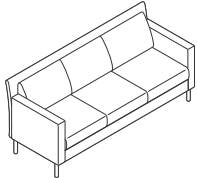

Overall: 30½"D 73"W 33"H  
 Inside: 20"D 66"W 33"H  
 Seat: 20"D 18½"W  
 Arm: 26¼"H

### 3-Seat Lounge

<b>391-3</b>	\$6652	\$6821	\$6894	\$7017	\$7391	\$7633	\$7913	\$8105	\$8452	\$8931	\$6890	\$14,446	\$16,133
--------------	--------	--------	--------	--------	--------	--------	--------	--------	--------	--------	--------	----------	----------

COM/yds = 8, COL/sq ft = 176

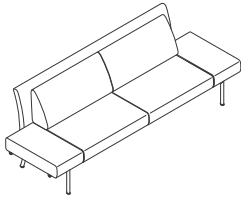

Lounge overall: 35"D 70½"W 33"H  
 Overall extended: 35"D 95½"W 33"H  
 Seat: 23"D 16½"W  
 Arm: 29"D 26½"W  
 One arm up: 77"H

### 2-Seat Lounge with Extensions

<b>391-4</b>	\$7046	\$7265	\$7344	\$7483	\$7903	\$8175	\$8489	\$8708	\$9097	\$9638	\$7284	\$15,940	\$17,824
--------------	--------	--------	--------	--------	--------	--------	--------	--------	--------	--------	--------	----------	----------

COM/yds = 9, COL/sq ft = 198



Overall: 17½"D 5¾"Dia

### Arm Bolster

<b>391-B</b>	\$ 331	\$ 323	\$ 332	\$ 348	\$ 395	\$ 424	\$ 459	\$ 484	\$ 528	\$ 588	\$ 725	\$ 1091	\$ 1451
--------------	--------	--------	--------	--------	--------	--------	--------	--------	--------	--------	--------	---------	---------

COM/yds = 1, COL/sq ft = 18

Lounge Seating

# SW\_1 Lounge Seating

DESIGN SCOTT WILSON & MINIMAL



Tip: For Customer's Own Material or Leather, see necessary requirements, important processing instructions, and ordering information  
 ▶ See page 198

Standard Includes		Required to Specify
▶ Need help? Product details, see <i>Coalesse Seating and Outdoor Specification Guide</i>	<ul style="list-style-type: none"> <li>• Seat: fabric or leather</li> <li>• Back: knit</li> <li>• Base: 8040 Aluminum Matte Polished</li> <li>• Frame: steel tube</li> <li>• Glides: aluminum with non marring plastic insert</li> <li>• Swivel return mechanism</li> <li>• Ottoman, if selected: fabric or leather</li> </ul>	1 Style number 2 Fabric or leather color number for seat or ottoman, if selected 3 Knit color number for back 4 Options, if selected (see below) ▶ See <i>Surface Materials</i> , page 196

Options	Price	Required to Specify
<b>Surface Materials</b>	<ul style="list-style-type: none"> <li>• Contrasting fabric +\$167</li> </ul>	Specify with <i>contrasting fabric</i> and select fabric color number.
<b>Acrylic backer</b>	<ul style="list-style-type: none"> <li>• Chairs +\$ 42</li> <li>• Ottoman +\$ 16</li> </ul>	Specify with <i>acrylic backer</i> . Specify with <i>acrylic backer</i> . ▶ See <i>Surface Materials</i> , page 196
<b>Lumbar pillow for lounge chairs</b>	<ul style="list-style-type: none"> <li>• Fabric group 6 +\$ 36</li> <li>• Fabric group 7 +\$ 43</li> <li>• Fabric group 8 +\$ 54</li> <li>• Fabric group 9 +\$ 89</li> <li>• Fabric group 10 +\$110</li> <li>• Fabric group 11 +\$138</li> <li>• Fabric group 12 +\$154</li> <li>• Fabric group 13 +\$188</li> <li>• Fabric group 14 +\$233</li> <li>• Leather group C +\$345</li> <li>• Leather group E +\$353</li> <li>• Customer's Own Material (COM) +\$ 55</li> <li>• Customer's Own Leather (COL) +\$375</li> </ul>	Specify fabric color number. Specify fabric color number. Specify fabric color number. Specify fabric color number. Specify fabric color number. Specify fabric color number. Specify fabric color number. Specify fabric color number. Specify fabric color number. Specify leather color number. Specify leather color number. Specify fabric color number. ▶ See <i>Surface Materials</i> , page 198 Specify leather color number. ▶ See <i>Surface Materials</i> , page 198
<b>Lumbar Pillow</b>	<ul style="list-style-type: none"> <li>• No pillow No cost</li> <li>• Pillow +\$313</li> </ul>	Specify with <i>no pillow</i> . Specify with <i>pillow</i> .
<b>Swivel Mechanism</b>	<ul style="list-style-type: none"> <li>• Swivel-only mechanism (omit return feature) No cost</li> </ul>	Specify with <i>swivel-only mechanism</i> .
<b>Tablet</b>	<ul style="list-style-type: none"> <li>• No tablet No cost</li> <li>• Right tablet (seated position) +\$936</li> <li>• Left tablet (seated position) +\$936</li> </ul>	Specify with <i>no tablet</i> . Specify with <i>right tablet</i> and select 6000 Black or 6052 Milk finish. Specify with <i>left tablet</i> and select 6000 Black or 6052 Milk finish.
<b>Related Products</b>	<ul style="list-style-type: none"> <li>• Collaborative and conference tables</li> <li>• Occasional tables</li> <li>• Collaboration seating</li> </ul>	▶ See <i>GSA Volume 5b Specification Guide</i> . ▶ See <i>GSA Volume 5b Specification Guide</i> . ▶ Page 169

Tip: Paint on lounge tablet arm support will complement 8040 Aluminum Matte polished base.



Top of Cushion to Bottom of Tablet: 8 1/2"H

Tip: Handedness is determined while in the seated position.

# SW\_1 Lounge Seating

DESIGN SCOTT WILSON & MINIMAL

## Specification Information

Style Number	Base Prices											Leather Grades:		
	Fabric Grades:											COL	C	E
	COM	6	7	8	9	10	11	12	13	14				



Overall: 28 1/4"D 32 1/4"W 36 3/4"H  
 Seat: 16"H  
 Arm: 23"H

### Low-Back Collaborative Lounge Chair

Style Number	Seat	COM	6	7	8	9	10	11	12	13	14	COL	C	E
COW613		\$2926	\$2926	\$2934	\$2949	\$2988	\$3016	\$3049	\$3070	\$3108	\$3163	\$2997	\$ 3314	\$3358
	Upper back	+\$ 99	+\$ 99	+\$119	+\$149	+\$250	+\$312	+\$386	+\$438	+\$527	+\$651	+\$263	+\$1000	+\$1111

COM/yds = 3, COL/sq ft = 60  
 Pillow COM/yds = 1 1/4, COL/sq ft = 27 1/2



Overall: 30"D 32 1/4"W 41 3/4"H  
 Seat: 16"H  
 Arm: 23"H

### High-Back Collaborative Lounge Chair

Style Number	Seat	COM	6	7	8	9	10	11	12	13	14	COL	C	E
COW713		\$3403	\$3403	\$3411	\$3426	\$3465	\$3493	\$3526	\$3547	\$3585	\$3640	\$3474	\$ 3791	\$3835
	Upper back	+\$ 99	+\$ 99	+\$119	+\$149	+\$250	+\$312	+\$386	+\$438	+\$527	+\$ 651	+\$263	+\$1000	+\$1111

COM/yds = 3, COL/sq ft = 60  
 Pillow COM/yds = 1 1/4, COL/sq ft = 27 1/2



Overall: 20"D 23"W 14"H

### Ottoman

Style Number	COM	6	7	8	9	10	11	12	13	14	COL	C	E	
COW210		\$1517	\$1509	\$1518	\$1534	\$1581	\$1610	\$1645	\$1670	\$1714	\$1774	\$1837	\$ 1981	\$2036

COM/yds = 1, COL/sq ft = 22

# SW\_1 Multi-Fabric Diagram

DESIGN STUDIO B

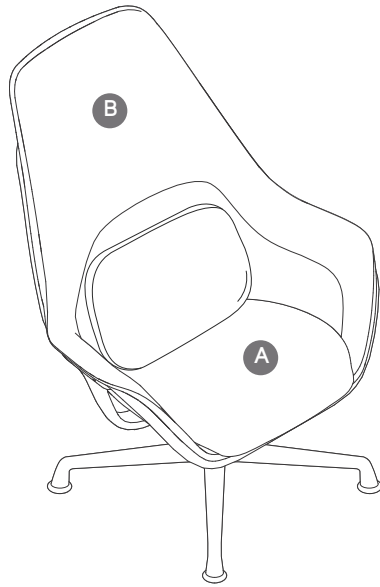

TO: \_\_\_\_\_

FROM: \_\_\_\_\_

DATE: \_\_\_\_\_

FAX...888.413.5161

**A** Seat: \_\_\_\_\_  
\_\_\_\_\_

**B** Arms/Back: \_\_\_\_\_  
\_\_\_\_\_

Contrasting fabric charges will apply. List price based on highest grade textile specified.

*Contrasting upcharge for each contrasting textile pricing based on highest grade textile specified. See specifying for contrasting upcharge.*

Specify Model below:

COW613 Low-Back Collaborative Lounge Chair

COW713 High-Back Collaborative Lounge Chair



# SW\_1 Multi-Fabric Diagram

DESIGN STUDIO B

# Together Bench by Walter Knoll

DESIGN E00S

*Tip: Fabrics and leathers will appear loose with comfort wrinkles when upholstered.*

*Tip: For Customer's Own Material or Leather, see necessary requirements, important processing instructions, and ordering information*  
 ▶ See *Coalesse Surface Materials Reference Guide*.

Standard Includes		Required to Specify	
▶ Need help? Product details, see <i>Coalesse Seating and Outdoor Specification Guide</i>	<ul style="list-style-type: none"> <li>Upholstery for chair: fabric or leather</li> <li>Glides</li> </ul>	1 Style number	2 Number of fabrics if contrasting fabric style number is selected
		3 Fabric or leather color number for upholstery	4 Options, if selected (see below)
		▶ See <i>Surface Materials</i> , page 196	

Surface Materials	Options	Price	Required to Specify
	<ul style="list-style-type: none"> <li>Contrasting fabric</li> </ul>	+\$167 per fabric	Add suffix K to the style number and select fabric color number.
	<b>Acrylic backer</b>		
	<ul style="list-style-type: none"> <li>71"W straight bench without back</li> </ul>	+\$ 49	Specify with acrylic backer.
	<ul style="list-style-type: none"> <li>97¾"W straight bench without back</li> </ul>	+\$ 55	Specify with acrylic backer.
	<ul style="list-style-type: none"> <li>26¾"D x 72"W and 70¾"W benches</li> </ul>	+\$ 70	Specify with acrylic backer.
	<ul style="list-style-type: none"> <li>26¾"D x 98¾"W and 97<sup>7</sup>/<sub>10</sub>"W benches</li> </ul>	+\$ 81	Specify with acrylic backer.
	<ul style="list-style-type: none"> <li>69¾"D x 96¼"W benches</li> </ul>	+\$132	Specify with acrylic backer.
	<ul style="list-style-type: none"> <li>96½"D x 96¼"W and 69¾"D x 123"W benches</li> </ul>	+\$151	Specify with acrylic backer.
	<ul style="list-style-type: none"> <li>96½"D x 123"W bench</li> </ul>	+\$167	Specify with acrylic backer.
			▶ See <i>Surface Materials</i> , page 196
<b>Back Offset</b>	<ul style="list-style-type: none"> <li>Back offset</li> </ul>	No cost	Specify with back offset.

### Specification Information

Style Number	Base Prices														Leather Grades:			
	Fabric Grades:														COL	C	E	
COM	6	7	8	9	10	11	12	13	14									

### Left Corner with Back, 8" Offset

<b>COT09669L8</b>	\$11,013	\$11,264	\$11,353	\$11,505	\$11,960	\$12,251	\$12,593	\$12,830	\$13,253	\$13,837	\$11,182	\$16,668	\$17,646
COM/yds = 9¾, COL/sq ft = 215													

<b>COT0969L8</b>	\$11,865	\$12,165	\$12,263	\$12,428	\$12,929	\$13,254	\$13,628	\$13,890	\$14,353	\$15,001	\$12,034	\$18,092	\$19,171
COM/yds = 10¾, COL/sq ft = 237													

▶ Specification Information, continued on next page

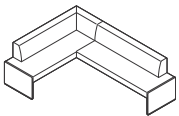

Overall: 70½"D 96¼"W 31"H  
 Seat: 19"D 18½"H

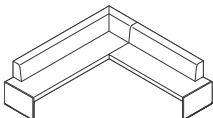

Overall: 97¼"D 96¼"W 31"H  
 Seat: 19"D 18½"H

# Together Bench by Walter Knoll

DESIGN EOOS

► Specification Information, continued from previous page

## Specification Information

Style Number	Base Prices											Leather Grades:		
	Fabric Grades:											COL	C	E
	COM	6	7	8	9	10	11	12	13	14				

### Left Corner with Back, 8" Offset, continued

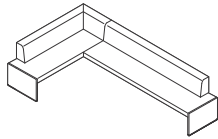

Overall: 70½"D 123"W 31"H  
Seat: 19"D 18½"H

<b>COTO12369L8</b>	\$12,202	\$12,526	\$12,626	\$12,799	\$13,324	\$13,663	\$14,057	\$14,329	\$14,814	\$15,491	\$12,371	\$18,713	\$19,844
--------------------	----------	----------	----------	----------	----------	----------	----------	----------	----------	----------	----------	----------	----------

COM/yds = 11¼, COL/sq ft = 248

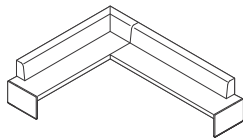

Overall: 97¼"D 123"W 31"H  
Seat: 19"D 18½"H

<b>COTO12396L8</b>	\$12,815	\$13,198	\$13,311	\$13,502	\$14,087	\$14,461	\$14,900	\$15,203	\$15,744	\$16,495	\$12,984	\$19,893	\$21,128
--------------------	----------	----------	----------	----------	----------	----------	----------	----------	----------	----------	----------	----------	----------

COM/yds = 12½, COL/sq ft = 270

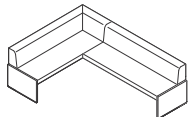

Overall: 70½"D 96¼"W 31"H  
Seat: 19"D 18½"H

<b>COTO9669L15</b>	\$11,245	\$11,519	\$11,613	\$11,771	\$12,250	\$12,558	\$12,917	\$13,168	\$13,611	\$14,223	\$11,414	\$17,186	\$18,216
--------------------	----------	----------	----------	----------	----------	----------	----------	----------	----------	----------	----------	----------	----------

COM/yds = 10¼, COL/sq ft = 226

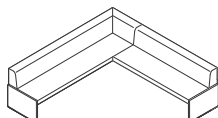

Overall: 97¼"D 96¼"W 31"H  
Seat: 19"D 18½"H

<b>COTO9696L15</b>	\$12,099	\$12,423	\$12,523	\$12,696	\$13,221	\$13,560	\$13,954	\$14,226	\$14,711	\$15,388	\$12,268	\$18,610	\$19,741
--------------------	----------	----------	----------	----------	----------	----------	----------	----------	----------	----------	----------	----------	----------

COM/yds = 11¼, COL/sq ft = 248

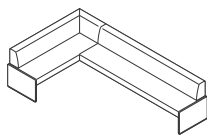

Overall: 70½"D 123"W 31"H  
Seat: 19"D 18½"H

<b>COTO12369L15</b>	\$12,432	\$12,778	\$12,886	\$13,066	\$13,612	\$13,969	\$14,378	\$14,662	\$15,171	\$15,876	\$12,601	\$19,230	\$20,410
---------------------	----------	----------	----------	----------	----------	----------	----------	----------	----------	----------	----------	----------	----------

COM/yds = 11¾, COL/sq ft = 259

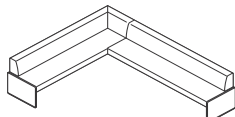

Overall: 97¼"D 123"W 31"H  
Seat: 19"D 18½"H

<b>COTO12396L15</b>	\$13,047	\$13,441	\$13,557	\$13,753	\$14,347	\$14,730	\$15,177	\$15,486	\$16,036	\$16,802	\$13,216	\$20,411	\$21,695
---------------------	----------	----------	----------	----------	----------	----------	----------	----------	----------	----------	----------	----------	----------

COM/yds = 12¾, COL/sq ft = 281

► Specification Information, continued on next page

# Together Bench by Walter Knoll *continued*

DESIGN EOOS

*Tip: For Customer's Own Material or Leather, see necessary requirements, important processing instructions, and ordering information*  
 ▶ See Coalesse Surface Materials Reference Guide.

*Tip: Fabrics and leathers will appear loose with comfort wrinkles when upholstered.*

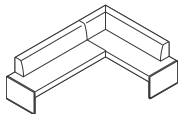

Overall: 70½"D 96¼"W 31"H  
 Seat: 19"D 18½"H

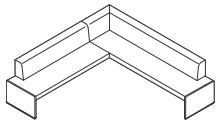

Overall: 97¼"D 96¼"W 31"H  
 Seat: 19"D 18½"H

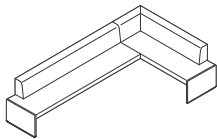

Overall: 70½"D 123"W 31"H  
 Seat: 19"D 18½"H

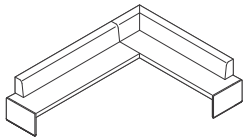

Overall: 97¼"D 123"W 31"H  
 Seat: 19"D 18½"H

▶ Specification Information, continued from previous page

## Specification Information

Style Number	Base Prices														Leather Grades:		
	Fabric Grades:														COL	C	E
	COM	6	7	8	9	10	11	12	13	14							

### Right Corner with Back, 8" Offset

**COT09669R8** \$11,013 \$11,264 \$11,353 \$11,505 \$11,960 \$12,251 \$12,593 \$12,830 \$13,253 \$13,837 \$11,182 \$16,668 \$17,646  
 COM/yds = 9¾, COL/sq ft = 215

**COT09696R8** \$11,865 \$12,165 \$12,263 \$12,428 \$12,929 \$13,254 \$13,628 \$13,890 \$14,353 \$15,001 \$12,034 \$18,092 \$19,171  
 COM/yds = 10¾, COL/sq ft = 237

**COT012369R8** \$12,202 \$12,526 \$12,626 \$12,799 \$13,324 \$13,663 \$14,057 \$14,329 \$14,814 \$15,491 \$12,371 \$18,713 \$19,844  
 COM/yds = 11¼, COL/sq ft = 248

**COT012396R8** \$12,815 \$13,198 \$13,311 \$13,502 \$14,087 \$14,461 \$14,900 \$15,203 \$15,744 \$16,495 \$12,984 \$19,893 \$21,128  
 COM/yds = 12½, COL/sq ft = 270

▶ Specification Information, continued on next page

# Together Bench by Walter Knoll

DESIGN EOOS

► Specification Information, continued from previous page

## Specification Information

Style Number	Base Prices										Leather Grades:		
	Fabric Grades:										COL	C	E
	COM	6	7	8	9	10	11	12	13	14			

### Right Corner with Back, 1 1/2" Offset

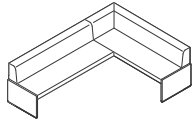

Overall: 70 1/2"D 96 1/4"W 31"H  
Seat: 19"D 18 1/2"H

<b>COT09669R15</b>	\$11,245	\$11,519	\$11,613	\$11,771	\$12,250	\$12,558	\$12,917	\$13,168	\$13,611	\$14,223	\$11,414	\$17,186	\$18,216
COM/yds = 10 1/4, COL/sq ft = 226													

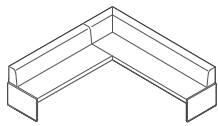

Overall: 97 1/4"D 96 1/4"W 31"H  
Seat: 19"D 18 1/2"H

<b>COT09696R15</b>	\$12,099	\$12,423	\$12,523	\$12,696	\$13,221	\$13,560	\$13,954	\$14,226	\$14,711	\$15,388	\$12,268	\$18,610	\$19,741
COM/yds = 11 1/4, COL/sq ft = 248													

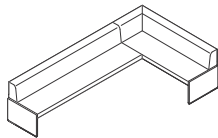

Overall: 70 1/2"D 123"W 31"H  
Seat: 19"D 18 1/2"H

<b>COT012369R15</b>	\$12,432	\$12,778	\$12,886	\$13,066	\$13,612	\$13,969	\$14,378	\$14,662	\$15,171	\$15,876	\$12,601	\$19,230	\$20,410
COM/yds = 11 3/4, COL/sq ft = 259													

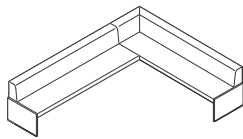

Overall: 97 1/4"D 123"W 31"H  
Seat: 19"D 18 1/2"H

<b>COT012396R15</b>	\$13,047	\$13,441	\$13,557	\$13,753	\$14,347	\$14,730	\$15,177	\$15,486	\$16,036	\$16,802	\$13,216	\$20,411	\$21,695
COM/yds = 12 3/4, COL/sq ft = 281													

► Specification Information, continued on next page

# Together Bench by Walter Knoll *continued*

DESIGN EOOS

*Tip: For Customer's Own Material or Leather, see necessary requirements, important processing instructions, and ordering information*

▶ See Coalesse Surface Materials Reference Guide.

*Tip: Fabrics and leathers will appear loose with comfort wrinkles when upholstered.*

▶ Specification Information, continued from previous page

## Specification Information

Style Number	Base Prices										Leather Grades:		
	Fabric Grades:										COL	C	E
	COM	6	7	8	9	10	11	12	13	14			

### Straight with Back, 8" Offset

<b>COTO69WB8</b>	\$5449	\$5466	\$5508	\$5582	\$5806	\$5949	\$6111	\$6229	\$6434	\$6720	\$5618	\$ 8255	\$ 8734
COM/yds = 4¾, COL/sq ft = 105													

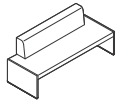

Overall: 26¾"D 72"W 31"H  
Seat: 19"D 18½"H

<b>COTO96WB8</b>	\$6233	\$6321	\$6376	\$6473	\$6764	\$6953	\$7173	\$7325	\$7592	\$7968	\$6402	\$ 9896	\$10,524
COM/yds = 6¼, COL/sq ft = 138													

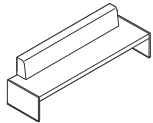

Overall: 26¾"D 98¾"W 31"H  
Seat: 19"D 18½"H

### Straight with Back, 1½" Offset

<b>COTO69WB15</b>	\$5678	\$5706	\$5752	\$5829	\$6063	\$6211	\$6389	\$6511	\$6725	\$7027	\$5847	\$ 8626	\$ 9131
COM/yds = 5, COL/sq ft = 110													

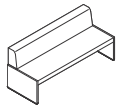

Overall: 26¾"D 70¾"W 31"H  
Seat: 19"D 18½"H

<b>COTO96WB15</b>	\$6464	\$6566	\$6622	\$6722	\$7027	\$7223	\$7449	\$7606	\$7888	\$8279	\$6633	\$10,268	\$10,921
COM/yds = 6½, COL/sq ft = 143													

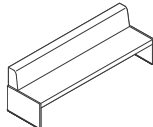

Overall: 26¾"D 97½"W 31"H  
Seat: 19"D 18½"H

▶ Specification Information, continued on next page

# Together Bench by Walter Knoll

DESIGN EOOS

► Specification Information, continued from previous page

## Specification Information

Style Number	Base Prices											Leather Grades:		
	Fabric Grades:											COL	C	E
	COM	6	7	8	9	10	11	12	13	14				

### Straight without Back

<b>COT069</b>	\$3922	\$3922	\$3957	\$4020	\$4207	\$4327	\$4466	\$4565	\$4733	\$4978	\$4109	\$6319	\$6723
COM/yds = 4, COL/sq ft = 88													

<b>COT096</b>	\$4473	\$4490	\$4532	\$4606	\$4830	\$4973	\$5135	\$5253	\$5458	\$5744	\$4642	\$7279	\$7758
COM/yds = 4¾, COL/sq ft = 105													

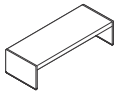

Overall: 26¾"D 71"W 18½"H  
Seat: 18½"H

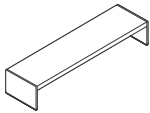

Overall: 26¾"D 97¾"W 18½"H  
Seat: 18½"H

Lounge Seating

# Visalia Lounge

DESIGN COALESSE DESIGN GROUP

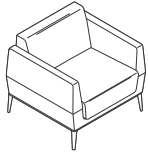

*Tip: Fabrics and leathers will appear loose with comfort wrinkles when upholstered.*

*Tip: All cushions are attached.*

*Tip: Recommended leathers are Elmosoft Grade C and Elmorustical Grade E.*

*Tip: Special color match, consult Customer Service.*

*Tip: For Customer's Own Material or Leather, see necessary requirements, important processing instructions, and ordering information*  
 ▶ See *Coalesse Surface Materials Reference Guide*.

Standard Includes	Required to Specify
<ul style="list-style-type: none"> <li>▶ Need help? Product details, see <i>Coalesse Seating and Outdoor Specification Guide</i></li> <li>• Frame: unibody construction with finger jointed plywood</li> <li>• Cast aluminum base: powder coat paint</li> <li>• Upholstery: multiple densities of polyurethane foams and polyester fiber on seat and back</li> <li>• Upper and lower upholstery accents with double needle top stitch, if selected</li> </ul>	<ol style="list-style-type: none"> <li>1 Style number</li> <li>2 Fabric or leather color number for seat, back, and arms</li> <li>3 Upholstery accent color number, if selected</li> <li>4 Paint color number for base:                         <ul style="list-style-type: none"> <li>4138 Graphite Gloss Black Matte</li> <li>4141 Platinum Matte</li> <li>4144 Black Gloss</li> <li>4145 Milk Gloss</li> <li>4148 Midnight Brown Gloss</li> <li>4180 Graphite Matte</li> <li>4193 Midnight Brown Matte</li> <li>4242 Milk Matte</li> <li>4710 Low Gloss Black</li> </ul> </li> <li>5 Options, if selected (see below)</li> </ol> ▶ See <i>Surface Materials</i> , page 196

Required Selections	Price	Required to Specify
Upholstery accent	Prices to right	Select accent upholstery.



Options	Price	Required to Specify
<b>Surface Materials</b> <b>Base</b> <ul style="list-style-type: none"> <li>• Grade 3 paint</li> </ul>	+\$133	Specify paint color number.
<b>Acrylic backer</b> <ul style="list-style-type: none"> <li>• Lounge chair with single fabric</li> <li>• Lounge chair with two fabrics</li> <li>• 2-seat lounge with single fabric</li> <li>• 2-seat lounge with two fabrics</li> <li>• 3-seat lounge with single fabric</li> <li>• 3-seat lounge with two fabrics</li> <li>• Ottomans with single fabric</li> <li>• Ottomans with two fabrics</li> <li>• 2-seat benches with single fabric</li> <li>• 2-seat benches with two fabrics</li> </ul>	<ul style="list-style-type: none"> <li>+\$ 49</li> <li>+\$ 55</li> <li>+\$ 68</li> <li>+\$ 74</li> <li>+\$ 77</li> <li>+\$ 87</li> <li>+\$ 24</li> <li>+\$ 24</li> <li>+\$ 30</li> <li>+\$ 30</li> </ul>	Specify with acrylic backer. Specify with acrylic backer. Specify with acrylic backer. Specify with acrylic backer. Specify with acrylic backer. Specify with acrylic backer. Specify with acrylic backer. Specify with acrylic backer. Specify with acrylic backer. Specify with acrylic backer. Specify with acrylic backer. Specify with acrylic backer. ▶ See <i>Surface Materials</i> , page 196



# Visalia Lounge

DESIGN COALESSE DESIGN GROUP

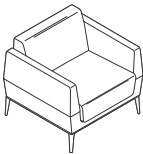
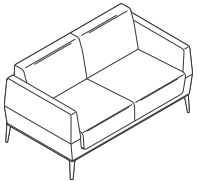
## Specification Information

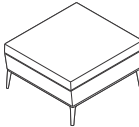
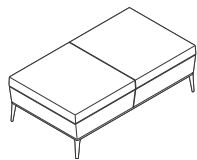
Lounge Chair	2-Seat Lounge	3-Seat Lounge	Ottoman	Bench										
														
Overall: 29"D 31¾"W 28"H Seat height: 16¼"H Arm height to the floor: 23"H Inside: 19"D 23"W 16¼"H	Overall: 29"D 53¾"W 28"H Seat height: 16¼"H Arm height to the floor: 23"H Inside: 19"D 45"W 16¼"H	Overall: 29"D 73¾"W 28"H Seat height: 16¼"H Arm height to the floor: 23"H Inside: 19"D 65"W 16¼"H	Overall: 29"D 30"W 16¼"H	Overall: 29"D 52"W 16¼"H										
Style Number	Upholstery	Base Prices										Leather Grades:		
		Fabric Grades:										COL	C	E
		COM	6	7	8	9	10	11	12	13	14			

Lounge Seating

### Lounge Chair with Single Fabric

COJHL100	\$2957	\$2957	\$2990	\$3045	\$3221	\$3333	\$3465	\$3554	\$3717	\$3943	\$3153	\$4480	\$4659
	COM/yds = 3¾, COL/sq ft = 83												

### Lounge Chair with Accent Upholstery

COJHLC100	Standard Upholstery	\$3040	\$3040	\$3069	\$3114	\$3252	\$3344	\$3447	\$3522	\$3652	\$3831	\$3185	\$4460	\$4626
		COM/yds = 3, COL/sq ft = 66												
	Accent Upholstery	+\$ 8	No cost	+\$ 9	+\$ 25	+\$ 72	+\$ 101	+\$ 136	+\$ 161	+\$ 205	+\$ 265	+\$ 328	+\$ 472	+\$ 527
		COM/yds = 1, COL/sq ft = 22												

### 2-Seat Lounge with Single Fabric

COJHL200	\$4537	\$4565	\$4611	\$4688	\$4922	\$5070	\$5248	\$5370	\$5584	\$5886	\$4706	\$6674	\$6921
	COM/yds = 5, COL/sq ft = 110												

### 2-Seat Lounge with Accent Upholstery

COJHLC200	Standard Upholstery	\$4669	\$4676	\$4717	\$4785	\$4997	\$5130	\$5288	\$5398	\$5590	\$5860	\$4838	\$6786	\$7036
		COM/yds = 4½, COL/sq ft = 99												
	Accent Upholstery	No cost	No cost	+\$ 13	+\$ 32	+\$ 89	+\$ 127	+\$ 171	+\$ 201	+\$256	+\$ 332	+\$ 317	+\$599	+\$667
		COM/yds = 1¼, COL/sq ft = 27												

### 3-Seat Lounge with Single Fabric

COJHL300	\$5188	\$5264	\$5319	\$5410	\$5692	\$5871	\$6081	\$6227	\$6487	\$6846	\$5357	\$7984	\$8303
	COM/yds = 6, COL/sq ft = 132												

### 3-Seat Lounge with Accent Upholstery

COJHLC300	Standard Upholstery	\$5346	\$5399	\$5451	\$5533	\$5790	\$5956	\$6148	\$6283	\$6519	\$6849	\$5515	\$8014	\$8319
		COM/yds = 5½, COL/sq ft = 121												
	Accent Upholstery	No cost	No cost	+\$ 14	+\$ 41	+\$ 122	+\$ 175	+\$ 236	+\$ 279	+\$ 356	+\$ 460	+\$ 291	+\$ 823	+\$ 916
		COM/yds = 1¾, COL/sq ft = 39												

► Specification Information, continued on next page

# Visalia Lounge *continued*

DESIGN COALESSE DESIGN GROUP

► Specification Information, continued from previous page

## Specification Information

### Lounge Chair

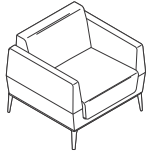

Overall: 29"D 31¾"W 28"H  
 Seat height: 16¼"H  
 Arm height to the floor: 23"H  
 Inside: 19"D 23"W 16¼"H

### 2-Seat Lounge

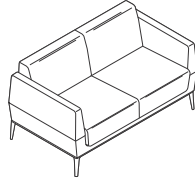

Overall: 29"D 53¾"W 28"H  
 Seat height: 16¼"H  
 Arm height to the floor: 23"H  
 Inside: 19"D 45"W 16¼"H

### 3-Seat Lounge

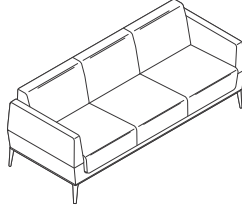

Overall: 29"D 73¾"W 28"H  
 Seat height: 16¼"H  
 Arm height to the floor: 23"H  
 Inside: 19"D 65"W 16¼"H

### Ottoman

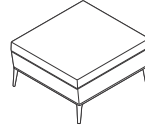

Overall: 29"D 30"W 16¼"H

### Bench

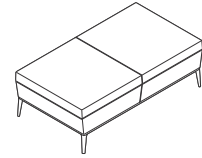

Overall: 29"D 52"W 16¼"H

Style Number	Upholstery	Base Prices											Leather Grades:		
		Fabric Grades:											COL	C	E
		COM	6	7	8	9	10	11	12	13	14				

### Ottoman with Single Fabric

COJHB100		\$1635	\$1635	\$1656	\$1690	\$1794	\$1862	\$1942	\$1997	\$2096	\$2230	\$1905	\$2570	\$2682
	COM/yds = 2, COL/sq ft = 44													

### Ottoman with Accent Upholstery

COJHBC100	Standard Upholstery	\$1706	\$1698	\$1707	\$1723	\$1770	\$1799	\$1834	\$1859	\$1903	\$1963	\$2026	\$2170	\$2225
	COM/yds = 1, COL/sq ft = 22													
	Accent Upholstery	+\$ 8	No cost	+\$ 9	+\$ 25	+\$ 72	+\$ 101	+\$ 136	+\$ 161	+\$ 205	+\$ 265	+\$ 328	+\$ 472	+\$ 527
	COM/yds = 1, COL/sq ft = 22													

### 2-Seat Bench with Single Fabric

COJHB200		\$2392	\$2392	\$2425	\$2480	\$2656	\$2768	\$2900	\$2989	\$3152	\$3378	\$2588	\$3654	\$3809
	COM/yds = 3, COL/sq ft = 50													

### 2-Seat Bench with Accent Upholstery

COJHBC200	Standard Upholstery	\$2429	\$2429	\$2443	\$2470	\$2551	\$2604	\$2665	\$2708	\$2785	\$2889	\$2720	\$3256	\$3352
	COM/yds = 1¾, COL/sq ft = 39													
	Accent Upholstery	No cost	No cost	+\$ 13	+\$ 32	+\$ 89	+\$ 127	+\$ 171	+\$ 201	+\$ 256	+\$ 332	+\$ 317	+\$ 599	+\$ 667
	COM/yds = 1, COL/sq ft = 22													

# Guest/Side/Stack Seating

Bindu Chairs	140
Bob Chair	141
Capa Chairs	142
Enea Café Wood Stools	144
Enea Lottus Chairs	146
Enea Lottus Sled Stools	150
Enea Lottus Post Stools	152
Kathryn Chairs	154
Lox Stools	156
Switch	158
Montara650	160
Montara650 Rocker	166
Wrapp Chairs	168

# Bindu Chairs

DESIGN BRIAN KANE

*Tip: Fabrics and leathers will appear loose with comfort wrinkles when upholstered.*

*Tip: Craft in upholstery cautions the use of stripes and patterns on Bindu. Please use fabric database when specifying.*

*Tip: For Customer's Own Material or Leather, see necessary requirements, important processing instructions, and ordering information*  
 ▶ See Coalesse Surface Materials Reference Guide.

*Tip: For fabric with large pattern and specific pattern location is desired, contact Customer Service.*



**Overall:** 25"D 24½"W 33¾"H  
**Inside:** 18¾"D 18½"-19½"W 15"H  
**Seat:** 17¾"H  
**Arm:** 26¼"H



**Overall:** 25"D 24½"W 37¾"H  
**Inside:** 18¾"D 18½"-19½"W 21"H  
**Seat:** 17¾"H  
**Arm:** 26¼"H

### Standard Includes

- ▶ Need help? Product details, see *Coalesse Seating and Outdoor Specification Guide*
- Bent plywood frame
- Chair: fabric
- Molded polypropylene foam
- Frame: 4144 Black Gloss
- Glides: black, non-marring

### Required to Specify

- 1 Style number
  - 2 Fabric or leather color number for upholstery
  - 3 Options, if selected (see below)
- ▶ See *Surface Materials*, page 196

### Options

Surface Materials	Options	Price	Required to Specify
	<b>Acrylic backer</b>		
	• Backer	+\$ 43	Specify with acrylic backer. ▶ See <i>Surface Materials</i> , page 196
<b>Base</b>	• 9207 polished trivalent chrome	+\$205	Specify with 9207 polished trivalent chrome.

### Specification Information

Style Number	Base Prices														Leather Grades:		
	Fabric Grades:														COL	C	E
	COM	6	7	8	9	10	11	12	13	14							

### Low-Back Chair

CO200G	\$1681	\$1681	\$1710	\$1755	\$1893	\$1985	\$2088	\$2163	\$2293	\$2472	\$1915	\$3556	\$3857
--------	--------	--------	--------	--------	--------	--------	--------	--------	--------	--------	--------	--------	--------

COM/yds = 3, COL/sq ft = 66

### Mid-Back Chair

CO300G	\$1928	\$1928	\$1957	\$2002	\$2140	\$2232	\$2335	\$2410	\$2540	\$2719	\$2162	\$3803	\$4104
--------	--------	--------	--------	--------	--------	--------	--------	--------	--------	--------	--------	--------	--------

COM/yds = 3, COL/sq ft = 66

# Bob Chair by Walter Knoll

DESIGN PEARSON LLOYD

*Tip: For Customer's Own Material or Leather, see necessary requirements, important processing instructions, and ordering information.*  
 ▶ Page 198

*Tip: Fabrics and leathers will appear loose with comfort wrinkles when upholstered.*

Standard Includes		Required to Specify	
▶ Need help? Product details, see <i>Coalesse Seating and Outdoor Specification Guide</i>	<ul style="list-style-type: none"> <li>Base: 8040 aluminum matte polished</li> <li>Upholstery for chair: fabric or leather</li> <li>Glides</li> </ul>	<ol style="list-style-type: none"> <li>Style number</li> <li>Number of fabrics if contrasting fabric style number is selected</li> <li>Fabric or leather color number for upholstery</li> <li>Options, if selected (see below)</li> </ol> ▶ See <i>Surface Materials</i> , page 196.	
Options		Price	Required to Specify
Surface Materials	• Contrasting fabric	+\$167 per fabric	Add suffix K to the style number and select fabric color number.
	<b>Acrylic backer</b>		
	• Guest chair	+\$ 30	Specify with acrylic backer.
	• Ottoman	+\$ 11	Specify with acrylic backer. ▶ See <i>Surface Materials</i> , page 196.
Glides	• Felted glides	+\$ 20	Specify with felted glides.
Related Products	• Bob tables		▶ See <i>GSA Volume 5b Specification Guide</i> .

Specification Information														
Style Number	Base Prices											Leather Grades:		
	Fabric Grades:											COL	C	E
	COM	6	7	8	9	10	11	12	13	14				

## Guest Chair

231	\$2525	\$2525	\$2544	\$2572	\$2666	\$2727	\$2798	\$2846	\$2931	\$3051	\$2820	\$3937	\$4142
-----	--------	--------	--------	--------	--------	--------	--------	--------	--------	--------	--------	--------	--------

COM/yds = 2, COL/sq ft = 44

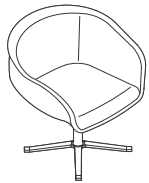

Overall: 25¼"D 27¼"W 29¾"H  
 Inside: 18"D 18"W 12½"H  
 Seat: 18½"H  
 Arm: 26½"H

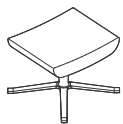

Overall: 18½"D 19¾"W 15¼"H

## Ottoman

221-H	\$1135	\$1127	\$1136	\$1152	\$1199	\$1228	\$1263	\$1288	\$1332	\$1392	\$1470	\$1992	\$2094
-------	--------	--------	--------	--------	--------	--------	--------	--------	--------	--------	--------	--------	--------

COM/yds = 1, COL/sq ft = 22

Guest/ Side/Stack Seating

# Capa Chairs

DESIGN EOOS



Overall: 24¾"D 23¾"W 31½"H  
 Inside: 18"D 16½"W 15"H  
 Seat: 18"H  
 Arm: 28"H

*Tip: Fabrics and leathers will appear loose with comfort wrinkles when upholstered.*

*Tip: Frame design allows back to flex to match occupant's back shape.*

*Tip: Due to the design and construction techniques of the Capa Chair only certain textiles can be successfully applied, therefore all COM fabrics must be submitted to Coalesse for approval prior to order acceptance.*

*Tip: Recommended leathers are Elmosoft Grade C and Elmorustical Grade E.*

*Tip: Special color match, consult Customer Service.*

*Tip: For Customer's Own Material or Leather, see necessary requirements, important processing instructions, and ordering information*  
 ▶ See Coalesse Surface Materials Reference Guide.

*Tip: Chair stacks five high with stacking dolly and three high on floor.*

Standard Includes		Required to Specify
▶ Need help? Product details, see <i>Coalesse Seating and Outdoor Specification Guide</i>	<ul style="list-style-type: none"> <li>• Frame: hardwood plywood, steel tubing and bar stock</li> <li>• Arms: solid steel rod and bar stock</li> <li>• Upholstery: arms, back, and seat foam are molded around the frame components</li> <li>• Legs: matte chrome (M) or polished chrome (PC) leg finish</li> </ul>	1 Style number 2 Number of fabrics if contrasting fabric style number is selected 3 Fabric or leather color number for upholstery 4 Options, if selected (see below) ▶ See <i>Coalesse Surface Materials Reference Guide</i> .

Options	Price	Required to Specify
<b>Surface Materials</b>	<ul style="list-style-type: none"> <li>• Contrasting fabric +\$167 per fabric</li> </ul>	Add suffix K to the style number and select fabric color number.
<ul style="list-style-type: none"> <li>• Acrylic backer</li> <li>• Backer</li> </ul>	+\$ 24	Specify with <i>acrylic backer</i> . ▶ See <i>Coalesse Surface Materials Reference Guide</i> .

Specification Information														
Style Number	Base Prices												Leather Grades:	
	Fabric Grades:												COL	C
	COM	6	7	8	9	10	11	12	13	14				

## Chairs

1810M	\$1559	\$1559	\$1578	\$1606	\$1700	\$1761	\$1832	\$1880	\$1965	\$2085	\$1921	\$3280	\$3527
1810PC	\$1598	\$1598	\$1617	\$1645	\$1739	\$1800	\$1871	\$1919	\$2004	\$2124	\$1960	\$3325	\$3566

COM/yds = 2, COL/sq ft = 44

## Stacking Dolly

9014S	\$1055	N.A.	N.A.	N.A.	N.A.	N.A.	N.A.	N.A.	N.A.	N.A.	N.A.	N.A.	N.A.
-------	--------	------	------	------	------	------	------	------	------	------	------	------	------

Coalesse SIN 33721

# Capa Chairs

DESIGN EOOS

Guest/Side/Stack  
Seating

# Enea Café Wood Stools

DESIGN JOSEP LLUSCA

*Tip: Recommended leathers are Elmosoft Grade C and Elmorustical Grade E.*

*Tip: Special color match, consult Customer Service.*

*Tip: For Customer's Own Material or Leather, see necessary requirements, important processing instructions, and ordering information*  
 ▶ See Coalesse Surface Materials Reference Guide.

Standard Includes	Required to Specify
<ul style="list-style-type: none"> <li>• Legs: solid oak with natural finish</li> <li>• Footring: 9201 Polished Trivalent Chrome</li> <li>• Seat and seat casting:                             <ul style="list-style-type: none"> <li>– Polypropylene seat with matching textured paint on seat casting, if selected</li> <li>– V3AK Rift-Cut Oak veneer plywood seat with 4062 Anthracite Grey textured paint on seat casting, if selected</li> <li>– Upholstered seat with textured paint on seat casting, if selected</li> </ul> </li> <li>• Glides, non-adjustable: black plastic</li> </ul>	<ol style="list-style-type: none"> <li>1 Style number</li> <li>2 Plastic color number for polypropylene seat, if selected</li> <li>3 Fabric or leather color number for upholstered seat, if selected</li> <li>4 Paint color number for seat casting, if upholstered seat selected:                             <ul style="list-style-type: none"> <li>4062 Anthracite Grey</li> <li>7207 Black</li> <li>7241 Arctic White</li> </ul> </li> <li>5 Options, if selected (see below)</li> </ol> ▶ See Coalesse Surface Materials Reference Guide.

Options	Price	Required to Specify
<b>Surface Materials</b> <ul style="list-style-type: none"> <li>• Acrylic backer</li> <li>• Backer</li> </ul>	+\$4	Specify with acrylic backer. ▶ See Coalesse Surface Materials Reference Guide.
<b>Related Products</b> <ul style="list-style-type: none"> <li>• Café tables</li> <li>• Occasional tables</li> <li>• Guest seating</li> </ul>		▶ See Coalesse Tables, Storage, and Accessories Specification Guide. ▶ See Coalesse Tables, Storage, and Accessories Specification Guide. ▶ Pages 140–146

Specification Information															
Style Number	Base Prices														
	Fabric Grades:														
	COM	6	7	8	9	10	11	12	13	14	Leather Grades:			Wood	Poly-propylene
											COL	C	E		

## Café Wood Counter-Height Stool with Upholstered Seat

COH352W27	\$1080	\$1050	\$1055	\$1066	\$1089	\$1103	\$1124	\$1136	\$1159	\$1192	\$1277	\$1517	\$1563	N.A.	N.A.
-----------	--------	--------	--------	--------	--------	--------	--------	--------	--------	--------	--------	--------	--------	------	------



Overall: 14½"D 16½"W 27½"H  
 Seat: 25¾"H

## Café Wood Bar-Height Stool with Upholstered Seat

COH352W31	\$1145	\$1115	\$1120	\$1131	\$1154	\$1168	\$1189	\$1201	\$1224	\$1257	\$1342	\$1582	\$1628	N.A.	N.A.
-----------	--------	--------	--------	--------	--------	--------	--------	--------	--------	--------	--------	--------	--------	------	------



Overall: 15¾"D 16½"W 31½"H  
 Seat: 29¾"H

## Café Wood Counter-Height Stools

Wood Seat															
COH350W27	N.A.	N.A.	N.A.	N.A.	N.A.	N.A.	N.A.	N.A.	N.A.	N.A.	N.A.	N.A.	N.A.	\$998	N.A.
Polypropylene Seat															
COH353W27	N.A.	N.A.	N.A.	N.A.	N.A.	N.A.	N.A.	N.A.	N.A.	N.A.	N.A.	N.A.	N.A.	N.A.	\$828

▶ Specification Information, continued on next page



# Enea Café Wood Stools

DESIGN JOSEP LLUSCA

► Specification Information, continued from previous page

## Specification Information

Style Number	Base Prices														Leather Grades:			Wood	Polypropylene
	Fabric Grades:														COL	C	E		
	COM	6	7	8	9	10	11	12	13	14									

### Café Wood Bar-Height Stools

#### Wood Seat

COH350W31	N.A.	N.A.	N.A.	N.A.	N.A.	N.A.	N.A.	N.A.	N.A.	N.A.	N.A.	N.A.	N.A.	N.A.	\$1063	N.A.
-----------	------	------	------	------	------	------	------	------	------	------	------	------	------	------	--------	------

#### Polypropylene Seat

COH353W31	N.A.	N.A.	N.A.	N.A.	N.A.	N.A.	N.A.	N.A.	N.A.	N.A.	N.A.	N.A.	N.A.	N.A.	N.A.	\$892
-----------	------	------	------	------	------	------	------	------	------	------	------	------	------	------	------	-------



Overall: 15¾"D 16½"W 31½"H  
Seat: 29¾"H

Guest/Side/Stack Seating

# Enea Lottus Chairs Armless

DESIGN LIEVORE ALTHERR MOLINA

*Tip: For Customer's Own Material or Leather, see necessary requirements, important processing instructions, and ordering information.*  
 ▶Page 198

Standard Includes		Required to Specify
▶Need help? Product details, see <i>Coalesse Seating and Outdoor Specification Guide</i>	<ul style="list-style-type: none"> <li>• Base and frame constructed of steel tubing</li> <li>• Seat and back: polypropylene</li> <li>• Insert, if selected: polypropylene or upholstery</li> </ul>	1 Style number 2 Plastic color number for seat and back 3 Fabric or leather color number for upholstery insert, if selected 4 Paint color number for base and frame 5 Options, if selected (see below) ▶See <i>Surface Materials</i> , page 196.

Options	Price	Required to Specify
<b>Surface Materials</b> <b>Base</b> <ul style="list-style-type: none"> <li>• Grade 1 paint</li> <li>• Grade 3 paint</li> </ul>	No cost +\$96	Specify paint color number. Specify paint color number.
<b>Acrylic backer</b> <ul style="list-style-type: none"> <li>• Chair with upholstered insert</li> </ul>	+\$ 6	Specify with acrylic backer. ▶See <i>Surface Materials</i> , page 196.
<b>Felt Glides</b> <ul style="list-style-type: none"> <li>• Glides</li> </ul>	No cost	Specify with felt glides.

### Specification Information

Style Number	Base Prices														Leather Grades:			Poly-propylene
	Fabric Grades:														COL	C	E	
	COM	6	7	8	9	10	11	12	13	14								

*Tip: Lottus chair with no insert stacks 10 high on floor. Lottus chair with polypropylene or upholstered insert stacks four high on floor. Lottus chairs stack six high with dolly.*



Overall: 20¾"D 20¾"W 30½"H  
 Seat: 18"H  
 Seat Depth: 16½"D



Overall: 20¾"D 20¾"W 30½"H  
 Seat: 18"H  
 Seat Depth: 16½"D



Overall: 20¾"D 20¾"W 30½"H  
 Seat: 18"H  
 Seat Depth: 16½"D

### Armless Chair with No Insert

COEL100	\$478	N.A.	N.A.	N.A.	N.A.	N.A.	N.A.	N.A.	N.A.	N.A.	N.A.	N.A.	N.A.	N.A.	N.A.	N.A.
---------	-------	------	------	------	------	------	------	------	------	------	------	------	------	------	------	------

### Armless Chair with Polypropylene Insert

COEL100INSERT	N.A.	N.A.	N.A.	N.A.	N.A.	N.A.	N.A.	N.A.	N.A.	N.A.	N.A.	N.A.	N.A.	N.A.	N.A.	\$534
---------------	------	------	------	------	------	------	------	------	------	------	------	------	------	------	------	-------

### Armless Chair with Upholstered Insert

COEL100UPH	\$714	\$695	\$702	\$713	\$748	\$769	\$797	\$813	\$847	\$892	\$1016	\$1032	\$1074	N.A.
------------	-------	-------	-------	-------	-------	-------	-------	-------	-------	-------	--------	--------	--------	------

COM/yds = ¾, COL/sq ft = 15

▶Specification Information, continued on next page

# Enea Lottus Chairs Armless

DESIGN LIEVORE ALTHERR MOLINA

► Specification Information, continued from previous page

## Specification Information

Style Number	Price
--------------	-------

---

### Stacking Dolly

---

COELDOLLY	\$1005
-----------	--------

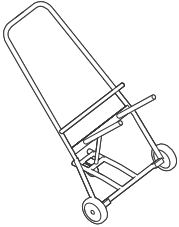

Overall: 27"D 25"W 46"H

*Tip: Dolly can be used with any Enea Lottus chair.*

*Tip: Armless chairs, cantilever arm chairs, and loop arm chairs stack six high on dolly.*

# Enea Lottus Chairs Cantilever Arm

DESIGN LIEVORE ALTHERR MOLINA

*Tip: Cantilever arm can hook on table to provide storing option.*

*Tip: Cantilever arm stacks six high.*

*Tip: Can specify arm cap in any plastic color for Lottus.*

*Tip: For Customer's Own Material or Leather, see necessary requirements, important processing instructions, and ordering information.*  
 ▶Page 198

Standard Includes		Required to Specify
▶Need help? Product details, see <i>Coalesse Seating and Outdoor Specification Guide</i>	<ul style="list-style-type: none"> <li>• Base and frame constructed of steel tubing</li> <li>• Seat and back: polypropylene</li> <li>• Arm cap: polypropylene</li> <li>• Insert, if selected: polypropylene or upholstery</li> </ul>	1 Style number 2 Plastic color number for seat, back, and arm cap 3 Fabric or leather color number for upholstery insert, if selected 4 Paint color number for base and frame 5 Options, if selected (see below) ▶See <i>Surface Materials</i> , page 196.

Options	Price	Required to Specify
<b>Surface Materials</b> <b>Base</b> <ul style="list-style-type: none"> <li>• Grade 1 paint</li> <li>• Grade 3 paint</li> </ul>	No cost +\$96	Specify paint color number. Specify paint color number.
<b>Acrylic backer</b> <ul style="list-style-type: none"> <li>• Chair with upholstered insert</li> </ul>	+\$ 6	Specify with acrylic backer. ▶See <i>Surface Materials</i> , page 196.
<b>Felt Glides</b> <ul style="list-style-type: none"> <li>• Glides</li> </ul>	No cost	Specify with felt glides.

### Specification Information

Style Number	Base Prices													
	Fabric Grades:										Leather Grades:			Polypropylene
	COM	6	7	8	9	10	11	12	13	14	COL	C	E	

### Cantilever Arm Chair with No Insert

COEL200	\$589	N.A.	N.A.	N.A.	N.A.	N.A.	N.A.	N.A.	N.A.	N.A.	N.A.	N.A.	N.A.	N.A.
---------	-------	------	------	------	------	------	------	------	------	------	------	------	------	------



Overall: 20¾"D 23¾"W 30½"H  
 Seat: 18"H  
 Seat Depth: 16½"D  
 Arm: 26"H

### Cantilever Arm Chair with Polypropylene Insert

COEL200INSERT	N.A.	N.A.	N.A.	N.A.	N.A.	N.A.	N.A.	N.A.	N.A.	N.A.	N.A.	N.A.	N.A.	\$646
---------------	------	------	------	------	------	------	------	------	------	------	------	------	------	-------



Overall: 20¾"D 23¾"W 30½"H  
 Seat: 18"H  
 Seat Depth: 16½"D  
 Arm: 26"H

### Cantilever Arm Chair with Upholstered Insert

COEL200UPH	\$824	\$805	\$812	\$823	\$858	\$879	\$907	\$923	\$957	\$1002	\$1126	\$1142	\$1184	N.A.
------------	-------	-------	-------	-------	-------	-------	-------	-------	-------	--------	--------	--------	--------	------

COM/yds = ¾, COL/sq ft = 15



Overall: 20¾"D 23¾"W 30½"H  
 Seat: 18"H  
 Seat Depth: 16½"D  
 Arm: 26"H

# Enea Lottus Chairs Aluminum Loop Arm

DESIGN LIEVORE ALTHERR MOLINA

Tip: Arm chair stacks six high.

Tip: For Customer's Own Material or Leather, see necessary requirements, important processing instructions, and ordering information.

▶ Page 198

Standard Includes		Required to Specify
▶ Need help? Product details, see <i>Coalesse Seating and Outdoor Specification Guide</i>	<ul style="list-style-type: none"> <li>• Base and frame constructed of steel tubing</li> <li>• Seat and back: polypropylene</li> <li>• Arm: aluminum</li> <li>• Insert, if selected: polypropylene or upholstery</li> </ul>	<ol style="list-style-type: none"> <li>1 Style number</li> <li>2 Plastic color number for seat, back, and arm cap</li> <li>3 Fabric or leather color number for upholstery insert, if selected</li> <li>4 Paint color number for base and frame</li> <li>5 Options, if selected (see below)</li> </ol> ▶ See <i>Surface Materials</i> , page 196.

Options	Price	Required to Specify	
<b>Surface Materials</b>	<b>Base</b> <ul style="list-style-type: none"> <li>• Grade 1 paint</li> <li>• Grade 3 paint</li> </ul>	No cost +\$96	Specify paint color number. Specify paint color number.
	<b>Acrylic backer</b> <ul style="list-style-type: none"> <li>• Chair with upholstered insert</li> </ul>	+\$ 6	Specify with acrylic backer. ▶ See <i>Surface Materials</i> , page 196.
<b>Felt Glides</b>	<ul style="list-style-type: none"> <li>• Glides</li> </ul>	No cost	Specify with felt glides.

### Specification Information

Style Number	Base Prices														Leather Grades:			Polypropylene
	Fabric Grades:														COL	C	E	
	COM	6	7	8	9	10	11	12	13	14								

### Aluminum Loop Arm Chair with No Insert

COEL300	\$638	N.A.	N.A.	N.A.	N.A.	N.A.	N.A.	N.A.	N.A.	N.A.	N.A.	N.A.	N.A.	N.A.	N.A.	N.A.
---------	-------	------	------	------	------	------	------	------	------	------	------	------	------	------	------	------



Overall: 20¾"D 22"W 30½"H  
 Seat: 18"H  
 Seat Depth: 16½"D  
 Arm: 26"H

### Aluminum Loop Arm Chair with Polypropylene Insert

COEL300INSERT	N.A.	N.A.	N.A.	N.A.	N.A.	N.A.	N.A.	N.A.	N.A.	N.A.	N.A.	N.A.	N.A.	N.A.	N.A.	\$690
---------------	------	------	------	------	------	------	------	------	------	------	------	------	------	------	------	-------



Overall: 20¾"D 22"W 30½"H  
 Seat: 18"H  
 Seat Depth: 16½"D  
 Arm: 26"H

### Aluminum Loop Arm Chair with Upholstered Insert

COEL300UPH	\$870	\$851	\$858	\$869	\$904	\$925	\$953	\$969	\$1003	\$1048	\$1190	\$1188	\$1230	N.A.
------------	-------	-------	-------	-------	-------	-------	-------	-------	--------	--------	--------	--------	--------	------

COM/yds = ¾, COL/sq ft = 15



Overall: 20¾"D 22"W 30½"H  
 Seat: 18"H  
 Seat Depth: 16½"D  
 Arm: 26"H

Guest/ Side/Stack Seating

# Enea Lottus Sled Stools Sled Base

DESIGN LIEVORE ALTHERR MOLINA

*Tip: For Customer's Own Material or Leather, see necessary requirements, important processing instructions, and ordering information.*  
 ▶Page 198

Standard Includes		Required to Specify
▶ Need help? Product details, see <i>Coalesse Seating and Outdoor Specification Guide</i>	<ul style="list-style-type: none"> <li>• Base and frame constructed of painted steel tubing</li> <li>• Seat and back: polypropylene</li> <li>• Insert, if selected: polypropylene or upholstery</li> </ul>	1 Style number 2 Plastic color number for seat and back 3 Fabric or leather color number for upholstery insert, if selected 4 Paint color number for base and frame 5 Options, if selected (see below) ▶ See <i>Surface Materials</i> , page 196.

Options	Price	Required to Specify
<b>Surface Materials</b> <b>Base</b> <ul style="list-style-type: none"> <li>• Grade 1 paint</li> <li>• Grade 3 paint</li> </ul>	No cost +\$96	Specify paint color number. Specify paint color number.
<b>Acrylic backer</b> <ul style="list-style-type: none"> <li>• Chair with upholstered insert</li> </ul>	+\$ 6	Specify with acrylic backer. ▶ See <i>Surface Materials</i> , page 196.

Specification Information														
Style Number	Base Prices													
	Fabric Grades:										Leather Grades:			Polypropylene
	COM	6	7	8	9	10	11	12	13	14	COL	C	E	

## Sled-Base Counter-Height Stool with No Insert

COEL500	\$700	N.A.	N.A.	N.A.	N.A.	N.A.	N.A.	N.A.	N.A.	N.A.	N.A.	N.A.	N.A.	N.A.
---------	-------	------	------	------	------	------	------	------	------	------	------	------	------	------



Overall: 18"D 18 1/4"W 34 1/2"H  
 Seat: 26 1/4"H  
 Seat Depth: 13 7/9"D

## Sled-Base Counter-Height Stool with Polypropylene Insert

COEL500INSERT	N.A.	N.A.	N.A.	N.A.	N.A.	N.A.	N.A.	N.A.	N.A.	N.A.	N.A.	N.A.	N.A.	\$740
---------------	------	------	------	------	------	------	------	------	------	------	------	------	------	-------



Overall: 18"D 18 1/4"W 34 1/2"H  
 Seat: 26 1/4"H  
 Seat Depth: 13 7/9"D

## Sled Base Counter-Height Stool with Upholstered Insert

COEL500UPH	\$918	\$899	\$906	\$917	\$952	\$973	\$1001	\$1017	\$1051	\$1096	\$1238	\$1236	\$1278	N.A.
------------	-------	-------	-------	-------	-------	-------	--------	--------	--------	--------	--------	--------	--------	------

COM/yds = 3/4, COL/sq ft = 15

▶ Specification Information, continued on next page



Overall: 18"D 18 1/4"W 34 1/2"H  
 Seat: 26 1/4"H  
 Seat Depth: 13 7/9"D

# Enea Lottus Sled Stools Sled Base

DESIGN LIEVORE ALTHERR MOLINA

► Specification Information, continued from previous page

## Specification Information

Style Number	Base Prices														Leather Grades:			Polypropylene
	Fabric Grades:														COL	C	E	
	COM	6	7	8	9	10	11	12	13	14								

### Sled Base Bar-Height Stool with No Insert

COEL400	\$769	N.A.	N.A.	N.A.	N.A.	N.A.	N.A.	N.A.	N.A.	N.A.	N.A.	N.A.	N.A.	N.A.	N.A.	N.A.	N.A.	N.A.
---------	-------	------	------	------	------	------	------	------	------	------	------	------	------	------	------	------	------	------



Overall: 18"D 18¼"W 38½"H  
 Seat: 30"H  
 Seat Depth: 137⁄9"D

### Sled Base Bar-Height Stool with Polypropylene Insert

COEL400INSERT	N.A.	N.A.	N.A.	N.A.	N.A.	N.A.	N.A.	N.A.	N.A.	N.A.	N.A.	N.A.	N.A.	N.A.	N.A.	N.A.	N.A.	\$810
---------------	------	------	------	------	------	------	------	------	------	------	------	------	------	------	------	------	------	-------



Overall: 18"D 18¼"W 38½"H  
 Seat: 30"H  
 Seat Depth: 137⁄9"D

### Sled Base Bar-Height Stool with Upholstered Insert

COEL400UPH	\$990	\$971	\$978	\$989	\$1024	\$1045	\$1073	\$1089	\$1123	\$1168	\$1310	\$1308	\$1350	N.A.				
------------	-------	-------	-------	-------	--------	--------	--------	--------	--------	--------	--------	--------	--------	------	--	--	--	--

COM/yds = ¾, COL/sq ft = 15



Overall: 18"D 18¼"W 38½"H  
 Seat: 30"H  
 Seat Depth: 137⁄9"D

Guest/ Side/Stack Seating

# Enea Lottus Post Stools Post Base

DESIGN LIEVORE ALTHERR MOLINA

*Tip: Post stool seat swivels.*

*Tip: For Customer's Own Material or Leather, see necessary requirements, important processing instructions, and ordering information.*

▶Page 198

Standard Includes	Required to Specify
▶Need help? Product details, see <i>Coalesse Seating and Outdoor Specification Guide</i>	1 Style number 2 Plastic color number for seat and back 3 Fabric or leather color number for upholstery insert, if selected 4 Paint color number for base and frame 5 Options, if selected (see below) ▶See <i>Surface Materials</i> , page 196.
<ul style="list-style-type: none"> <li>• Base and frame constructed of painted steel tubing</li> <li>• Seat and back: polypropylene</li> <li>• Insert, if selected: polypropylene or upholstery</li> <li>• Foot ring: paint to match the base and frame</li> </ul>	

Options	Price	Required to Specify
<b>Surface Materials</b>  <b>Base</b> <ul style="list-style-type: none"> <li>• Grade 1 paint</li> <li>• Grade 3 paint</li> </ul>	No cost +\$133	Specify paint color number. Specify paint color number.
<b>Acrylic backer</b> <ul style="list-style-type: none"> <li>• Chair with upholstered insert</li> </ul>	+\$ 6	Specify with <i>acrylic backer</i> . ▶ See <i>Surface Materials</i> , page 196.
<ul style="list-style-type: none"> <li>• Polished trivalent chrome ring</li> </ul>	+\$ 85	Specify with <i>trivalent chrome ring</i> .

Specification Information														
Style Number	Base Prices													
	Fabric Grades:													
	COM	6	7	8	9	10	11	12	13	14	Leather Grades:			Poly-propylene
											COL	C	E	

## Post Base Counter-Height Stool with No Insert

COEL700	\$1351	N.A.	N.A.	N.A.	N.A.	N.A.	N.A.	N.A.	N.A.	N.A.	N.A.	N.A.	N.A.	N.A.
---------	--------	------	------	------	------	------	------	------	------	------	------	------	------	------

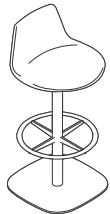

Overall: 19¾"D 19¾"W 34½"H  
 Seat: 26¼"H  
 Seat Depth: 13⅞"D

## Post Base Counter-Height Stool with Polypropylene Insert

COEL700INSERT	N.A.	N.A.	N.A.	N.A.	N.A.	N.A.	N.A.	N.A.	N.A.	N.A.	N.A.	N.A.	N.A.	N.A.	\$1389
---------------	------	------	------	------	------	------	------	------	------	------	------	------	------	------	--------

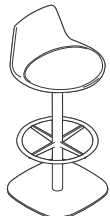

Overall: 19¾"D 19¾"W 34½"H  
 Seat: 26¼"H  
 Seat Depth: 13⅞"D

## Post Base Counter-Height Stool with Upholstered Insert

COEL700UPH	\$1569	\$1550	\$1557	\$1568	\$1603	\$1624	\$1652	\$1668	\$1702	\$1747	\$1889	\$1887	\$1929	N.A.
------------	--------	--------	--------	--------	--------	--------	--------	--------	--------	--------	--------	--------	--------	------

COM/yds = ¾, COL/sq ft = 15

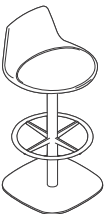

Overall: 19¾"D 19¾"W 34½"H  
 Seat: 26¼"H  
 Seat Depth: 13⅞"D

▶Specification Information, continued on next page



# Enea Lottus Post Stools Post Base

DESIGN LIEVORE ALTHERR MOLINA

► Specification Information, continued from previous page

## Specification Information

Style Number	Base Prices														Leather Grades:			Poly-propylene
	Fabric Grades:														COL	C	E	
	COM	6	7	8	9	10	11	12	13	14								

### Post Base Bar-Height Stool with No Insert

COEL600	\$1366	N.A.	N.A.	N.A.	N.A.	N.A.	N.A.	N.A.	N.A.	N.A.	N.A.	N.A.	N.A.	N.A.	N.A.	N.A.	N.A.
---------	--------	------	------	------	------	------	------	------	------	------	------	------	------	------	------	------	------

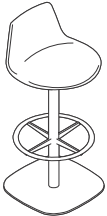

Overall: 19¾"D 19¾"W 38½"H  
 Seat: 30"H  
 Seat Depth: 137⁹⁄₁₆"D

### Post Base Bar-Height Stool with Polypropylene Insert

COEL600INSERT	N.A.	N.A.	N.A.	N.A.	N.A.	N.A.	N.A.	N.A.	N.A.	N.A.	N.A.	N.A.	N.A.	N.A.	N.A.	N.A.	\$1405
---------------	------	------	------	------	------	------	------	------	------	------	------	------	------	------	------	------	--------

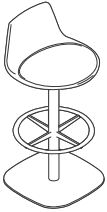

Overall: 19¾"D 19¾"W 38½"H  
 Seat: 30"H  
 Seat Depth: 137⁹⁄₁₆"D

### Post Base Bar-Height Stool with Upholstered Insert

COEL600UPH	\$1585	\$1566	\$1573	\$1584	\$1619	\$1640	\$1668	\$1684	\$1718	\$1763	\$1905	\$1903	\$1945	N.A.			
------------	--------	--------	--------	--------	--------	--------	--------	--------	--------	--------	--------	--------	--------	------	--	--	--

COM/yds = ¾, COL/sq ft = 15

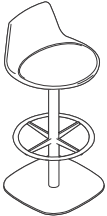

Overall: 19¾"D 19¾"W 38½"H  
 Seat: 30"H  
 Seat Depth: 137⁹⁄₁₆"D

Guest/ Side/Stack Seating

# Kathryn Chairs

DESIGN STUDIO B

*Tip: Fabrics and leathers will appear loose with comfort wrinkles when upholstered.*

*Tip: Recommended leathers are Elmosoft Grade C and Elmorustical Grade E.*

*Tip: Special color match, consult Customer Service.*

*Tip: For Customer's Own Material or Leather, see necessary requirements, important processing instructions, and ordering information.*

▶Page 198

Standard Includes		Required to Specify
▶Need help? Product details, see <i>Coalesse Seating and Outdoor Specification Guide</i>	<ul style="list-style-type: none"> <li>• Frame: European beech hardwood</li> <li>• Mortise and tenon joinery</li> <li>• Upholstery: multiple densities of laminated polyurethane foam and polyester fiber</li> <li>• Glides: non-adjustable</li> </ul>	1 Style number 2 Number of fabrics if contrasting fabric style number is selected 3 Fabric or leather color number for upholstery 4 Wood color number for frame ▶See <i>Hardwood and Veneer Matrix</i> , page 210 5 Options, if selected (see below) ▶See <i>Surface Materials</i> , page 196.

Options	Price	Required to Specify
<b>Surface Materials</b>		
• Contrasting fabric	+\$167 per fabric	Add suffix K to the style number and select fabric color number.
• Contrasting welt	+\$191	Specify with <i>contrasting welt</i> and select fabric color number.
<b>Acrylic backer</b>		
• Chair with open back	+\$ 9	Specify with <i>acrylic backer</i> .
• Chair with upholstery	+\$ 18	Specify with <i>acrylic backer</i> . ▶See <i>Surface Materials</i> , page 196.

Specification Information													
Style Number	Base Prices											Leather Grades:	
	Fabric Grades:											COL	C
	COM	6	7	8	9	10	11	12	13	14			

## Wood with Open Back Chair

2540-1	\$1344	\$1336	\$1350	\$1360	\$1378	\$1394	\$1447	\$1485	\$1532	\$1633	\$1693	\$2074	\$2164
--------	--------	--------	--------	--------	--------	--------	--------	--------	--------	--------	--------	--------	--------

COM/yds = 1, COL/sq ft = 18

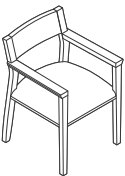

Overall: 22¾"D 22¾"W 32"H  
 Inside: 19"D 18½"W 14"H  
 Seat: 18"H  
 Arm: 26"H

## Wood/Upholstered with Panel Back Chair

2542-1	\$1401	\$1405	\$1423	\$1439	\$1463	\$1492	\$1570	\$1657	\$1694	\$1777	\$1738	\$2342	\$2484
--------	--------	--------	--------	--------	--------	--------	--------	--------	--------	--------	--------	--------	--------

COM/yds = 1½, COL/sq ft = 27

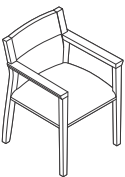

Overall: 22¾"D 22¾"W 32"H  
 Inside: 19"D 18½"W 14"H  
 Seat: 18"H  
 Arm: 26"H

## Fully Upholstered Back

2547-1	\$1579	\$1583	\$1607	\$1617	\$1641	\$1670	\$1748	\$1800	\$1883	\$1974	\$1916	\$2520	\$2662
--------	--------	--------	--------	--------	--------	--------	--------	--------	--------	--------	--------	--------	--------

COM/yds = 1½, COL/sq ft = 27

▶Specification Information, continued on next page

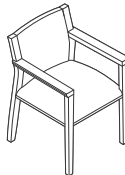

Overall: 22¾"D 22¾"W 32"H  
 Inside: 19"D 18½"W 14"H  
 Seat: 18"H  
 Arm: 26"H

# Kathryn Chairs

DESIGN STUDIO B

► Specification Information, continued from previous page

**Specification Information**

Style Number	Base Prices											Leather Grades:		
	Fabric Grades:											COL	C	E
	COM	6	7	8	9	10	11	12	13	14				

**Fully Upholstered Back with Ribbed Upholstery**

2547-1RIBD	\$1628	\$1632	\$1656	\$1666	\$1690	\$1719	\$1797	\$1849	\$1932	\$2023	\$1965	\$2569	\$2711
------------	--------	--------	--------	--------	--------	--------	--------	--------	--------	--------	--------	--------	--------

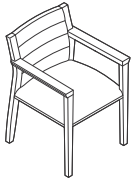

Guest/Side/Stack Seating

# Lox Stools

DESIGN PEARSONLLOYD

*Tip: Due to the design and construction techniques of the Lox stools only certain textiles can be successfully applied, therefore all COM fabrics must be submitted to Coalesse for approval prior to order acceptance.*

*Tip: For Customer's Own Material or Leather, see necessary requirements, important processing instructions, and ordering information.*  
▶Page 198

*Tip: In high-traffic applications, scuff marks on footrest may be visible in white gloss.*

Standard Includes		Required to Specify
▶Need help? Product details, see <i>Coalesse Seating and Outdoor Specification Guide</i>	<ul style="list-style-type: none"> <li>• Shell and ribbon-shaped footrest: plastic</li> <li>• Base: 9251 Brushed Chrome</li> <li>• Seat: upholstered foam</li> <li>• Swivel mechanism</li> <li>• Height-adjustable button under seat</li> <li>• Felt glides</li> </ul>	1 Style number 2 Plastic color number for shell: 6347 Black Gloss 6348 White Gloss 3 Fabric or leather color number for upholstery 4 Options, if selected (see below) ▶See <i>Surface Materials</i> , page 196.

Options	Price	Required to Specify
<b>Surface Materials</b> Acrylic backer • Backer	+\$6	Specify with acrylic backer. ▶See <i>Surface Materials</i> , page 196.

### Specification Information

Style Number	Base Prices														Leather Grades:		
	Fabric Grades:														COL	C	E
	COM	6	7	8	9	10	11	12	13	14							

### Counter-Height Stool

COLX200	\$1745	\$1726	\$1733	\$1744	\$1779	\$1800	\$1828	\$1844	\$1878	\$1923	\$2065	\$1999	\$2031
COM/yds = $\frac{3}{4}$ , COL/sq ft = 13													



Overall: 17"D 17"W 28"-32"H  
Seat: 26"-30"H

### Bar-Height Stool

COLX210	\$1819	\$1800	\$1807	\$1818	\$1853	\$1874	\$1902	\$1918	\$1952	\$1997	\$2139	\$2073	\$2105
COM/yds = $\frac{3}{4}$ , COL/sq ft = 13													



Overall: 17"D 17"W 31"-34"H  
Seat: 29"-33"H

# Switch Guest

DESIGN EOOS

*Tip: Fabrics and leathers will appear loose with comfort wrinkles when upholstered.*

*Tip: Recommended leathers are Elmosoft Grade C and Elmorustical Grade E.*

*Tip: Special color match, consult Customer Service.*

*Tip: For Customer's Own Material or Leather, see necessary requirements, important processing instructions, and ordering information.*  
▶Page 198

*Tip: Pricing based on highest grade textile specified.*

*Tip: Steel springs allow back to flex to match occupant's back shape.*

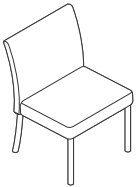

**Overall:** 22½"D 21½"W 33½"H  
**Inside:** 18½"D 19¼"W 15½"H  
**Seat:** 18½"H

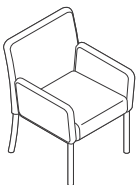

**Overall:** 22½"D 25¾"W 33½"H  
**Inside:** 18½"D 19"W 15½"H  
**Seat:** 18½"H  
**Arm:** 26½"H

Standard Includes		Required to Specify
▶Need help? Product details, see <i>Coalesse Seating and Outdoor Specification Guide</i>	<ul style="list-style-type: none"> <li>• Frame: constructed of steel tubing and bar stock</li> <li>• Arms: solid steel rod and bar stock</li> <li>• Upholstery: Back and seat are molded foam and fiber</li> <li>• Legs: matte chrome (M) or polished chrome (PC) leg finish</li> </ul>	1 Style number 2 Number of fabrics if contrasting fabric style number is selected 3 Fabric or leather color number for upholstery on seat 4 Options, if selected (see below) ▶See <i>Surface Materials</i> , page 196

Options	Price	Required to Specify
<b>Surface Materials</b>	<ul style="list-style-type: none"> <li>• Contrasting fabric +\$167 per fabric</li> </ul>	Add suffix K to the style number and select fabric color number.
<b>Acrylic backer</b>	<ul style="list-style-type: none"> <li>• Armless chair +\$ 24</li> <li>• Arm chair +\$ 36</li> </ul>	Specify with acrylic backer. Specify with acrylic backer. ▶See <i>Surface Materials</i> , page 196

Specification Information													
Style Number	Base Prices												
	Fabric Grades:												
	COM	6	7	8	9	10	11	12	13	14	Leather Grades:		
											COL	C	E

Armless Chairs													
1500M	\$1657	\$1657	\$1671	\$1693	\$1765	\$1808	\$1862	\$1899	\$1961	\$2051	\$2025	\$2988	\$3163
1500PC	\$1716	\$1716	\$1730	\$1752	\$1824	\$1867	\$1921	\$1958	\$2020	\$2110	\$2084	\$3047	\$3223

COM/yds = 1½, COL/sq ft = 27

Arm Chairs													
1510M	\$1893	\$1893	\$1914	\$1954	\$2070	\$2145	\$2230	\$2293	\$2401	\$2549	\$2218	\$3864	\$4159
1510PC	\$1962	\$1962	\$1983	\$2023	\$2139	\$2214	\$2299	\$2362	\$2470	\$2618	\$2287	\$3916	\$4228

COM/yds = 2½, COL/sq ft = 45

Guest/ Side/Stack Seating

# Switch Stools without Arms

DESIGN EOOS

*Tip: Fabrics and leathers will appear loose with comfort wrinkles when upholstered.*

*Tip: Recommended leathers are Elmosoft Grade C and Elmorustical Grade E.*

*Tip: Special color match, consult Customer Service.*

*Tip: Pricing based on highest grade textile specified.*

*Tip: For Customer's Own Material or Leather, see necessary requirements, important processing instructions, and ordering information.*

► Page 198

Standard Includes		Required to Specify	
► Need help? Product details, see <i>Coalesse Seating and Outdoor Specification Guide</i>	<ul style="list-style-type: none"> <li>• Frame: Constructed of steel tubing and bar stock</li> <li>• Upholstery: back foam are molded around the frame components.</li> <li>• Seat foam is molded with "comfort pockets"</li> <li>• Legs: matte chrome (M) or polished chrome (PC) leg finish</li> </ul>	<ol style="list-style-type: none"> <li>1 Style number</li> <li>2 Number of fabrics if contrasting fabric style number is selected</li> <li>3 Fabric or leather color number for upholstery</li> <li>4 Options, if selected (see below)</li> </ol>	► See <i>Surface Materials</i> , page 196.
Options		Required to Specify	
<b>Surface Materials</b>	<ul style="list-style-type: none"> <li>• Contrasting fabric</li> </ul>	+\$167 per fabric	Add suffix K to the style number and select fabric color number.
	<b>Acrylic backer</b>		
	<ul style="list-style-type: none"> <li>• Backer</li> </ul>	+\$ 11	Specify with <i>acrylic backer</i> . ► See <i>Surface Materials</i> , page 196.
<b>Related Products</b>	<ul style="list-style-type: none"> <li>• Guest seating</li> <li>• Occasional tables</li> </ul>		► Page 158 ► See <i>GSA Volume 5b Specification Guide</i> .

## Specification Information

Style Number	Base Prices											Leather Grades:		
	Fabric Grades:											COL	C	E
	COM	6	7	8	9	10	11	12	13	14				

## Counter-Height Stools

1404M	\$1695	\$1695	\$1708	\$1727	\$1784	\$1822	\$1866	\$1896	\$1951	\$2027	\$2081	\$2861	\$3013
1404PC	\$1727	\$1727	\$1740	\$1759	\$1816	\$1854	\$1898	\$1928	\$1983	\$2059	\$2113	\$2893	\$3053

COM/yds = 1¼, COL/sq ft = 23

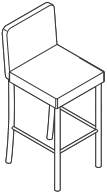

Overall: 19"D 16"W 38"H  
Inside: 15"D 15"W 11¾"H  
Seat: 27¾"H

## Bar-Height Stools

1405M	\$1745	\$1745	\$1758	\$1777	\$1834	\$1872	\$1916	\$1946	\$2001	\$2077	\$2126	\$2911	\$3063
1405PC	\$1795	\$1795	\$1808	\$1827	\$1884	\$1922	\$1966	\$1996	\$2051	\$2127	\$2181	\$2961	\$3113

COM/yds = 1¼, COL/sq ft = 23

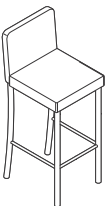

Overall: 19¾"D 16"W 41½"H  
Inside: 15"D 15"W 11¾"H  
Seat: 31¼"H

Coalesse SIN 33721

# Switch

Stools without Arms

DESIGN EOOS

# Montara650 Chairs

DESIGN LIEVORE ALTHERR MOLINA



Tip: Chairs stack six high.

Tip: Leathers will appear loose with comfort wrinkles when upholstered.

Tip: For Customer's Own Material or Leather, see necessary requirements, important processing instructions, and ordering information.

► Page 198

Standard Includes	Required to Specify
-------------------	---------------------

<ul style="list-style-type: none"> <li>► Need help?</li> <li>Product details, see <i>Coalesse Seating and Outdoor Specification Guide</i></li> </ul>	<ul style="list-style-type: none"> <li>• Seat and back: upholstery, if selected</li> <li>• Shell: wood shell, wood shell with upholstered seat, or ¾ upholstery with wood shell, if selected: wood veneer grade 1</li> <li>• Base: paint</li> <li>• Glides</li> </ul>	<ol style="list-style-type: none"> <li>1 Style number</li> <li>2 Upholstery version (see below under Required Selections)</li> <li>3 Contrasting fabric on ¾ or fully upholstered, if selected (see below under Required Selections)</li> <li>4 Fabric and/or leather color number for seat and/or back, if selected</li> <li>5 Wood finish on shell, if selected</li> <li>6 Base type (see below under Required Selections)</li> <li>7 Paint color number for base</li> <li>8 Options, if selected (see below)</li> </ol> <p>► See <i>Surface Materials</i>, page 196</p>
--	---	--

Required Selections	Price	Required to Specify
---------------------	-------	---------------------

<b>Upholstery Version</b>	<ul style="list-style-type: none"> <li>• Wood shell</li> <li>• Wood shell with upholstered seat</li> <li>• Wood shell with ¾ upholstery</li> <li>• Fully upholstered</li> </ul>	Prices at right Prices at right Prices at right Prices at right	Specify with <i>wood seat and back</i> . Specify with <i>upholstered seat, wood back</i> . Specify with <i>¾ upholstered</i> . Specify with <i>upholstered seat and back</i> .
<b>Contrasting Fabric on ¾ and Fully Upholstered</b>	<ul style="list-style-type: none"> <li>• Non contrasting fabric</li> <li>• Contrasting fabric</li> </ul>	No cost +\$167	Specify with <i>non contrasting fabric</i> . Specify with <i>contrasting fabric</i> .
<b>Base Type</b>	<ul style="list-style-type: none"> <li>• 4-leg</li> <li>• Sled base</li> <li>• Sled base with cantilever arms</li> <li>• 4-leg base with loop arms</li> </ul>	No cost +\$ 66 +\$193 +\$153	Specify with <i>4-leg</i> . Specify with <i>sled base</i> . Specify with <i>sled cantilever arm</i> . Specify with <i>4-leg loop arm</i> .

Options	Price	Required to Specify
---------	-------	---------------------

<b>Surface Materials</b>	<b>Base, armless</b> <ul style="list-style-type: none"> <li>• Polished trivalent chrome base</li> <li>• Grade 3 paint</li> </ul>	+\$ 68 +\$ 96	Specify with <i>polished trivalent chrome</i> . Specify paint color number.
	<b>Base, with arms</b> <ul style="list-style-type: none"> <li>• Polished trivalent chrome base Shell</li> <li>• Grade 3 paint</li> </ul>	+\$223 +\$ 96	Specify with <i>polished trivalent chrome</i> . Specify paint color number.
	<b>Wood shell</b> <ul style="list-style-type: none"> <li>• Grade 1 wood veneer</li> <li>• Grade 2 wood veneer</li> </ul>	No cost +\$ 81	Specify with <i>VP01 Oak Light, VP03 Black Oak, or VP05 White Oak</i> . Specify with <i>VP02 Smoked Oak or VP04 Grey Oak</i> .
	<b>Acrylic backer</b> <ul style="list-style-type: none"> <li>• Seat</li> <li>• Seat and back</li> </ul>	+\$ 8 +\$ 21	Specify with <i>acrylic backer</i> . Specify with <i>acrylic backer</i> .

<b>Related Products</b>	<ul style="list-style-type: none"> <li>• Tables</li> <li>• Stools</li> </ul>	► See <i>GSA Volume 5b Specification Guide</i> . ► Pages 164
-------------------------	--	---



# Montara650 Chairs

DESIGN LIEVORE ALTHERR MOLINA

## Specification Information



**4-leg, armless**  
Overall: 20½"W x 20½"D x 31"H  
Seat: 17½"H



**4-leg with loop arms**  
Overall: 24"W x 20½"D x 31"H  
Seat: 17½"H  
Arms: 25¼"H



**Sled base, armless**  
Overall: 20½"W x 20½"D x 31"H  
Seat: 17½"H



**Sled base with cantilever arms**  
Overall: 22"W x 20½"D x 31"H  
Seat: 17½"H  
Arms: 25"H

Style  
Number

Base Price

### Wood Shell Chair

COSFZCH	Seat	\$ 687
---------	------	--------

Style  
Number

Base Prices

Fabric Grades:

COM	6	7	8	9	10	11	12	13	14	Leather Grades:		
										COL	C	E

### Wood Shell Chair with Upholstered Seat

COSFZCH	Seat	\$ 871	\$841	\$846	\$855	\$ 880	\$ 894	\$ 913	\$ 926	\$ 948	\$ 982	\$1153	\$1026	\$1071
---------	------	--------	-------	-------	-------	--------	--------	--------	--------	--------	--------	--------	--------	--------

### Wood Shell Chair with ¾ Upholstery

COSFZCH	Seat	\$1003	\$973	\$978	\$987	\$1012	\$1026	\$1045	\$1058	\$1080	\$ 1114	\$1285	\$1158	\$1203
	Back	+\$ 54	+\$24	+\$29	+\$38	+\$ 63	+\$ 77	+\$ 96	+\$109	+\$ 131	+\$165	+\$108	+\$209	+\$254

### Fully Upholstered Chair

COSFZCH	Seat	\$ 905	\$875	\$880	\$889	\$ 914	\$ 928	\$ 947	\$ 960	\$ 982	\$1016	\$1187	\$1060	\$1105
	Back	+\$ 54	+\$50	+\$58	+\$74	+\$124	+\$155	+\$194	+\$218	+\$263	+\$328	+\$108	+\$462	+\$555

Guest/ Side/Stack Seating

# Montara650 Lounge Chair

DESIGN LIEVORE ALTHERR MOLINA



*Tip: Leathers will appear loose with comfort wrinkles when upholstered.*

*Tip: For Customer's Own Material or Leather, see necessary requirements, important processing instructions, and ordering information.*

► See *Coalesse Surface Materials Reference Guide* and online fabric database at <http://fabric.coalesse.com>.

Standard Includes		Required to Specify
► Need help? Product details, see <i>Coalesse Seating and Outdoor Specification Guide</i>	<ul style="list-style-type: none"> <li>• Seat and back upholstery, if selected</li> <li>• Shell: wood shell with <sup>3</sup>/<sub>4</sub> upholstery or wood shell with upholstered seat, if selected: wood veneer grade 1</li> <li>• Sled base: grade 1 paint</li> <li>• Glides</li> </ul>	<ol style="list-style-type: none"> <li>1 Style number</li> <li>2 Upholstery version (see below under Required Selections)</li> <li>3 Contrasting fabric on <sup>3</sup>/<sub>4</sub> upholstered or fully upholstered, if selected (see below under Required Selections)</li> <li>4 Fabric and/or leather color number for seat and/or back, if selected</li> <li>5 Wood finish on shell, if selected</li> <li>6 Paint color number for base</li> <li>7 Options, if selected (see below)</li> </ol> <p>► See <i>Coalesse Surface Materials Reference Guide</i>.</p>

	Required Selections	Price	Required to Specify
<b>Upholstery Version</b>	<ul style="list-style-type: none"> <li>• Wood shell with <sup>3</sup>/<sub>4</sub> upholstery</li> <li>• Wood shell with upholstered seat</li> <li>• Fully upholstered</li> </ul>	Prices at right Prices at right Prices at right	Specify with <sup>3</sup> / <sub>4</sub> upholstered. Specify with upholstered seat and wood back. Specify with upholstered seat and back.
<b>Contrasting Fabric on Fully Upholstered</b>	<ul style="list-style-type: none"> <li>• Non contrasting fabric</li> <li>• Contrasting fabric</li> </ul>	No cost +\$167	Specify with non contrasting fabric. Specify with contrasting fabric.

	Options	Price	Required to Specify
<b>Surface Materials</b>	<b>Base</b>		
	<ul style="list-style-type: none"> <li>• Grade 3 paint</li> <li>• Polished trivalent chrome base</li> </ul>	+\$ 96 +\$100	Specify paint color number. Specify with polished trivalent chrome.
	<b>Shell</b>		
	<ul style="list-style-type: none"> <li>• Grade 1 wood veneer</li> <li>• Grade 2 wood veneer</li> </ul>	No cost +\$ 81	Specify with VP01 Oak Light, VP03 Black Oak, or VP05 White Oak. Specify with VP02 Smoked Oak or VP04 Grey Oak.
	<b>Acrylic backer</b>		
	<ul style="list-style-type: none"> <li>• Seat</li> <li>• Seat and back</li> </ul>	+\$ 8 +\$ 21	Specify with acrylic backer. Specify with acrylic backer.

Related Products		
• Guest seating		► See <i>Coalesse Seating and Outdoor Specification Guide</i> .
• Stools		► See <i>Coalesse Seating and Outdoor Specification Guide</i> .
• Café tables		► See <i>Coalesse Tables, Storage, and Accessories Specification Guide</i> .
• Occasional tables		► See <i>Coalesse Tables, Storage, and Accessories Specification Guide</i> .

# Montara650 Lounge Chair

DESIGN LIEVORE ALTHERR MOLINA



Overall: 25½"D x 29"W x 21¼"H  
Seat: 16"

Overall: 25½"D x 29"W x 21¼"H  
Seat: 16"

Overall: 25½"D x 29"W x 21¼"H  
Seat: 16"

## Specification Information

Style Number	Base Prices													
	Fabric Grades:											Leather Grades:		
	COM	6	7	8	9	10	11	12	13	14	COL	C	E	

### Wood Shell Lounge Chair with Upholstered Seat

COSFZLC	Seat	\$1173	\$1169	\$1177	\$1194	\$1244	\$1274	\$1312	\$1337	\$1382	\$1446	\$1447	\$1371	\$1424
COM/yds = 1, COL/sq ft = 9														

### Wood Shell Lounge Chair with ¾ Upholstered Back

COSFZLC	Seat	\$1300	\$1296	\$1304	\$1321	\$1371	\$1401	\$1439	\$1464	\$1509	\$1573	\$1574	\$1498	\$1551
	Back	+\$ 54	+\$ 38	+\$ 44	+\$ 56	+\$ 94	+\$118	+\$145	+\$165	+\$198	+\$244	+\$105	+\$502	+\$605
COM/yds = 1, COL/sq ft = 17														

### Fully Upholstered Lounge Chair

COSFZLC	Seat	\$1205	\$1201	\$1209	\$1226	\$1276	\$1306	\$1344	\$1369	\$1414	\$1478	\$1479	\$1403	\$1456
	Back	+\$ 54	+\$ 74	+\$ 89	+\$114	+\$187	+\$234	+\$289	+\$328	+\$396	+\$492	+\$105	+\$628	+\$758
COM/yds = 2½, COL/sq ft = 32														

Guest/ Side/Stack Seating

# Montara650 Stools

DESIGN LIEVORE ALTHERR MOLINA

*Tip: Leathers will appear loose with comfort wrinkles when upholstered.*

*Tip: For Customer's Own Material or Leather, see necessary requirements, important processing instructions, and ordering information.*

► Page 198

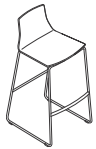

Stool at bar height

Overall: 18¾"W x 19½"D x 39½"H  
Seat: 30"H

**COM yardage:**

Seat: ¾ yards

Fully uph. back: 1¼ yards

**COL yardage:**

Seat: 7 yards

Fully uph. back: 18 yards

Standard Includes	Required to Specify
-------------------	---------------------

- |   |  |
|---|--|
| <ul style="list-style-type: none"> <li>► Need help? Product details, see <i>Coalesse Seating and Outdoor Specification Guide</i></li> </ul> | <ul style="list-style-type: none"> <li>• Seat and back upholstery, if selected</li> <li>• Shell: wood shell or wood shell with upholstered seat, if selected: wood veneer grade 1</li> <li>• Sled base: grade 1 paint</li> <li>• Glides</li> </ul> |
|---|--|

- 1 Style number
  - 2 Application (see below under Required Selections)
  - 3 Upholstery version (see below under Required Selections)
  - 4 Contrasting fabric on fully upholstered, if selected (see below under Required Selections)
  - 5 Fabric and/or leather color number for seat and/or back, if selected
  - 6 Wood finish on shell, if selected
  - 7 Paint color number for base
  - 8 Options, if selected (see below)
- See *Surface Materials*, page 196.

Application	Required Selections	Price	Required to Specify
-------------	---------------------	-------	---------------------

<b>Application</b>	<ul style="list-style-type: none"> <li>• Counter height</li> <li>• Bar height</li> </ul>	No cost +\$ 66	Specify with counter height. Specify with bar height.
<b>Upholstery Version</b>	<ul style="list-style-type: none"> <li>• Wood shell</li> <li>• Wood shell with upholstered seat</li> <li>• Fully upholstered</li> </ul>	Price below Prices at right Prices at right	Specify with wood seat and back. Specify with upholstered seat and wood back. Specify with upholstered seat and back.
<b>Contrasting Fabric on Fully Upholstered</b>	<ul style="list-style-type: none"> <li>• Non contrasting fabric</li> <li>• Contrasting fabric</li> </ul>	No cost +\$167	Specify with non contrasting fabric. Specify with contrasting fabric.

Surface Materials	Options	Price	Required to Specify
-------------------	---------	-------	---------------------

<b>Surface Materials</b>	<b>Base</b>		
	<ul style="list-style-type: none"> <li>• Grade 3 paint</li> <li>• Polished trivalent chrome base</li> </ul>	+\$ 96 +\$100	Specify paint color number. Specify with polished trivalent chrome.
	<b>Shell</b>		
	<ul style="list-style-type: none"> <li>• Grade 1 wood veneer</li> <li>• Grade 2 wood veneer</li> </ul>	No cost +\$ 81	Specify with VP01 Oak Light, VP03 Black Oak, or VP05 White Oak. Specify with VP02 Smoked Oak or VP04 Grey Oak.
	<b>Acrylic backer</b>		
	<ul style="list-style-type: none"> <li>• Seat</li> <li>• Seat and back</li> </ul>	+\$ 8 +\$21	Specify with acrylic backer. Specify with acrylic backer.

<b>Related Products</b>	<ul style="list-style-type: none"> <li>• Tables</li> <li>• Chairs</li> <li>• Café tables</li> <li>• Occasional tables</li> </ul>	<ul style="list-style-type: none"> <li>► See <i>GSA Volume 5b Specification Guide</i>.</li> <li>► Page 160</li> <li>► See <i>GSA Volume 5b Specification Guide</i>.</li> <li>► See <i>GSA Volume 5b Specification Guide</i>.</li> </ul>
-------------------------	--	---

## Specification Information

Style Number	Base Price
--------------	------------

### Wood Shell Stool

COSFZST	\$949
---------	-------

► Specification Information, continued on next page



Overall: 18½"W x 19½"D x 35½"H  
Seat: 26"H

# Montara650 Stools

DESIGN LIEVORE ALTHERR MOLINA

► Specification Information, continued from previous page

## Specification Information

Style Number	Base Prices													
	Fabric Grades:											Leather Grades:		
	COM	6	7	8	9	10	11	12	13	14	COL	C	E	

### Wood Shell Stool with Upholstered Seat

Style Number	Configuration	COM	6	7	8	9	10	11	12	13	14	COL	C	E
COSFZST	Seat	\$1133	\$1103	\$1108	\$1117	\$1142	\$1156	\$1175	\$1188	\$1210	\$1244	\$1415	\$1336	\$1391



Overall: 18½"W x 19½"D x 35½"H  
Seat: 26"H

### Fully Upholstered Stool

Style Number	Configuration	COM	6	7	8	9	10	11	12	13	14	COL	C	E
COSFZST	Seat	\$1167	\$1137	\$1142	\$1151	\$1176	\$1190	\$1209	\$1222	\$1244	\$1278	\$1449	\$1370	\$1425
	Back	+\$54	+\$50	+\$58	+\$74	+\$124	+\$155	+\$194	+\$218	+\$263	+\$328	+\$390	+\$462	+\$555

Overall: 18½"W x 19½"D x 35½"H  
Seat: 26"H

Guest/Side/Stack Seating

# Montara650 Rocker

DESIGN LIEVORE ALTHERR MOLINA



*Tip: Leathers will appear loose with comfort wrinkles when upholstered.*

*Tip: For Customer's Own Material or Leather, see necessary requirements, important processing instructions, and ordering information. ▶ See page 196.*



With arms

Standard Includes	Required to Specify
-------------------	---------------------

<ul style="list-style-type: none"> <li>▶ Need help? Product details, see <i>Coalesse Seating and Outdoor Specification Guide</i></li> </ul>	<ul style="list-style-type: none"> <li>• Seat and back upholstery, if selected</li> <li>• Shell: wood shell with <sup>3</sup>/<sub>4</sub> upholstery or wood shell with upholstered seat, if selected: wood veneer grade 1</li> <li>• Base: paint</li> <li>• Runners: solid oak in clear finish</li> </ul>	<ol style="list-style-type: none"> <li>1 Style number</li> <li>2 Upholstery version (see below under Required Selections)</li> <li>3 Contrasting fabric on <sup>3</sup>/<sub>4</sub> upholstered or fully upholstered, if selected (see below under Required Selections)</li> <li>4 Fabric and/or leather color number for seat and/or back, if selected</li> <li>5 Wood finish on shell, if selected</li> <li>6 Paint color number for base</li> <li>7 Options, if selected (see below)</li> </ol> <p>▶ See <i>Surface Materials</i>, page 196.</p>
---	---	--

Required Selections	Price	Required to Specify
---------------------	-------	---------------------

<b>Upholstery Version</b>	<ul style="list-style-type: none"> <li>• Wood shell with <sup>3</sup>/<sub>4</sub> upholstery</li> <li>• Wood shell with upholstered seat</li> <li>• Fully upholstered</li> </ul>	<p>Prices at right</p> <p>Prices at right</p> <p>Prices at right</p>	<p>Specify with <sup>3</sup>/<sub>4</sub> upholstered.</p> <p>Specify with upholstered seat and wood back.</p> <p>Specify with upholstered seat and back.</p>
<b>Contrasting Fabric on <sup>3</sup>/<sub>4</sub> and Fully Upholstered</b>	<ul style="list-style-type: none"> <li>• Non contrasting fabric</li> <li>• Contrasting fabric</li> </ul>	<p>No cost</p> <p>+\$167</p>	<p>Specify with non contrasting fabric.</p> <p>Specify with contrasting fabric.</p>
<b>Arm Type</b>	<ul style="list-style-type: none"> <li>• Armless</li> <li>• With arms</li> </ul>	<p>No cost</p> <p>+\$127</p>	<p>Specify with no arms.</p> <p>Specify with arms.</p>

Options	Price	Required to Specify
---------	-------	---------------------

<b>Surface Materials</b>	<p><b>Base, armless</b></p> <ul style="list-style-type: none"> <li>• Grade 3 paint</li> <li>• Polished trivalent chrome base</li> </ul>	<p>+\$ 96</p> <p>+\$100</p>	<p>Specify paint color number.</p> <p>Specify with polished trivalent chrome.</p>
	<p><b>Base, with arms</b></p> <ul style="list-style-type: none"> <li>• Grade 3 paint</li> <li>• Polished trivalent chrome base</li> </ul>	<p>+\$ 96</p> <p>+\$222</p>	<p>Specify paint color number.</p> <p>Specify with polished trivalent chrome.</p>
	<p><b>Wood shell</b></p> <ul style="list-style-type: none"> <li>• Grade 1 wood veneer</li> <li>• Grade 2 wood veneer</li> </ul>	<p>No cost</p> <p>+\$ 81</p>	<p>Specify with VP01 Oak Light, VP03 Black Oak, or VP05 White Oak.</p> <p>Specify with VP02 Smoked Oak or VP04 Grey Oak.</p>
	<p><b>Acrylic backer</b></p> <ul style="list-style-type: none"> <li>• Seat</li> <li>• Seat and back</li> </ul>	<p>+\$ 8</p> <p>+\$ 21</p>	<p>Specify with acrylic backer.</p> <p>Specify with acrylic backer.</p>
<b>Related Products</b>	<ul style="list-style-type: none"> <li>• Guest seating</li> <li>• Stools</li> <li>• Café tables</li> <li>• Occasional tables</li> </ul>		<p>▶ Page 160</p> <p>▶ Page 164</p> <p>▶ See <i>GSA Volume 5b Specification Guide</i>.</p> <p>▶ See <i>GSA Volume 5b Specification Guide</i>.</p>

# Montara650 Rocker

DESIGN LIEVORE ALTHERR MOLINA



Overall: 29"D x 28½"W x 30"H  
Seat: 16"

Overall: 29"D x 28½"W x 30"H  
Seat: 16"

Overall: 29"D x 28½"W x 30"H  
Seat: 16"

## Specification Information

Style Number	Base Prices														Leather Grades:		
	Fabric Grades:														COL	C	E
	COM	6	7	8	9	10	11	12	13	14							

### Wood Shell Rocker with Upholstered Seat

COSFZRC	Seat	\$1793	\$1789	\$1797	\$1814	\$1864	\$1894	\$1932	\$1957	\$2002	\$2066	\$ 2067	\$ 1991	\$2044
COM/yds = 1, COL/sq ft = 9														

### Wood Shell Rocker with ¾ Upholstered Back

COSFZRC	Seat	\$1920	\$1916	\$1924	\$1941	\$1991	\$2021	\$2059	\$2084	\$2129	\$ 2193	\$ 2194	\$ 2118	\$ 2171
	Back	+\$ 54	+\$ 38	+\$ 44	+\$ 56	+\$ 94	+\$118	+\$145	+\$165	+\$198	+\$244	+\$ 105	+\$502	+\$605
COM/yds = 1, COL/sq ft = 17														

### Fully Upholstered Rocker

COSFZRC	Seat	\$1825	\$1821	\$1829	\$1846	\$1896	\$1926	\$1964	\$1989	\$2034	\$2098	\$ 2099	\$2023	\$2076
	Back	+\$ 54	+\$ 74	+\$ 89	+\$114	+\$187	+\$234	+\$289	+\$328	+\$396	+\$492	+\$1876	+\$628	+\$758
COM/yds = 2½, COL/sq ft = 32														

Guest/ Side/ Stack Seating

# Wrapp Chairs by Viccarbe

DESIGN MARK KRUSIN

*Tip: Fabrics and leathers will appear loose with comfort wrinkles when upholstered.*

*Tip: Stacking is not recommended as the frame will dent the foam on the seat on which it is being stacked.*

*Tip: For Customer's Own Material or Leather, see necessary requirements, important processing instructions, and ordering information*  
 ▶ See *Coalesse Surface Materials Reference Guide*.

Standard Includes		Required to Specify
▶ Need help? Product details, see <i>Coalesse Seating and Outdoor Specification Guide</i>	<ul style="list-style-type: none"> <li>Upholstery for chair: fabric or leather</li> <li>Frame: polished trivalent chrome</li> </ul>	1 Style number 2 Number of fabrics if contrasting fabric style number is selected 3 Fabric or leather color number for upholstery 4 Options, if selected (see below) ▶ See <i>Coalesse Surface Materials Reference Guide</i> .

Options	Price	Required to Specify
<b>Surface Materials</b>	<ul style="list-style-type: none"> <li>Contrasting fabric</li> </ul>	+\$167 per fabric
	<ul style="list-style-type: none"> <li><b>Acrylic backer</b></li> <li>Backer</li> </ul>	+\$ 18
		Add suffix K to the style number and select fabric color number.  Specify with <i>acrylic backer</i> . ▶ See <i>Coalesse Surface Materials Reference Guide</i> .

Specification Information													
Style Number	Base Prices												
	Fabric Grades:												
	COM	6	7	8	9	10	11	12	13	14	Leather Grades:		
											COL	C	E

## Four-Leg Chair

<b>COWRP4LEG</b>	\$1704	\$1704	\$1718	\$1740	\$1812	\$1855	\$1909	\$1946	\$2008	\$2098	\$2008	\$2793	\$2941
COM/yds = 1½, COL/sq ft = 33													



**Overall:** 21"D 25¼"W 29½"H  
**Inside:** 16"D 19½"W 17½"H  
**Seat:** 17½"H

## Sled-Base Chair

<b>COWRPSLD</b>	\$1764	\$1764	\$1778	\$1800	\$1872	\$1915	\$1969	\$2006	\$2068	\$2158	\$2068	\$2853	\$3001
COM/yds = 1½, COL/sq ft = 33													

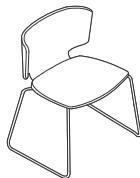

**Overall:** 20¼"D 24½"W 28¾"H  
**Inside:** 16"D 19½"W 17½"H  
**Seat:** 17½"H



# Collaboration Seating

Bindu Conference Seating	170
Chord Conference Seating	172
SW_1 Conference Seating	174

# Bindu Conference Seating

DESIGN BRIAN KANE

*Tip: Fabrics and leathers will appear loose with comfort wrinkles when upholstered.*

*Tip: For Customer's Own Material or Leather, see necessary requirements, important processing instructions, and ordering information.*  
▶Page 198

*Tip: Craft in upholstery cautions the use of stripes and patterns on Bindu. Please use fabric database when specifying.*

*Tip: For fabric with a large pattern and a specific pattern location is desired, contact Customer Service.*

## Standard Includes

- ▶Need help? Product details, see *Coalesse Seating and Outdoor Specification Guide*
- Bent plywood frame
- Chair: fabric
- Molded polypropylene foam
- Base: 6205 Black Resin
- Dual wheel hard casters, conference
- Back tilt lock

## Required to Specify

- 1 Style number
- 2 Fabric or leather color number for upholstery
- 3 Options, if selected (see below)
- ▶See *Surface Materials*, page 196.

## Options

Options	Price	Required to Specify
<b>Surface Materials</b>	<ul style="list-style-type: none"> <li>• Acrylic backer +\$ 43</li> <li>• Mid-back chair +\$ 45</li> <li>• High-back chair</li> </ul>	Specify with acrylic backer. Specify with acrylic backer. ▶ See <i>Surface Materials</i> , page 196.
<b>Base</b>	<ul style="list-style-type: none"> <li>• 8046 Polished Aluminum (available on CO300 &amp; CO400) +\$205</li> </ul>	Specify with 8046 Polished Aluminum.
<b>Casters</b>	<ul style="list-style-type: none"> <li>• Soft casters +\$ 32</li> </ul>	Specify with soft casters.

## Specification Information

Style Number	Base Prices											Leather Grades:		
	Fabric Grades:											COL	C	E
	COM	6	7	8	9	10	11	12	13	14				

### Mid-Back Conference Chair

CO300	\$2008	\$2008	\$2037	\$2082	\$2220	\$2312	\$2415	\$2490	\$2620	\$2799	\$2242	\$3883	\$4184
-------	--------	--------	--------	--------	--------	--------	--------	--------	--------	--------	--------	--------	--------

COM/yds = 3, COL/sq ft = 66



Overall: 25"D 25"W 35½"-40¼"H  
 Inside: 18¾"D 18½"-19½"W 21"H  
 Seat: 16"-20½"H  
 Arm: 24¼"-29"H

### High-Back Conference Chair

CO400	\$2344	\$2344	\$2376	\$2425	\$2578	\$2673	\$2787	\$2867	\$3009	\$3204	\$2568	\$4349	\$4677
-------	--------	--------	--------	--------	--------	--------	--------	--------	--------	--------	--------	--------	--------

COM/yds = 3.25, COL/sq ft = 72



Overall: 25"D 25"W 45½"-50¼"H  
 Inside: 18¾"D 18½"-19½"W 31"H  
 Seat: 16"-20½"H  
 Arm: 24¼"-29"H

Coalesse SIN 33721

# Bindu Conference Seating

DESIGN BRIAN KANE

# Chord Conference Seating

DESIGN MICHAEL SHIELDS

*Tip: Fabrics and leathers will appear loose with comfort wrinkles when upholstered.*

*Tip: For Customer's Own Material or Leather, see necessary requirements, important processing instructions, and ordering information.*  
 ▶Page 198

*Tip: Arm is cast from 100% recycled material then hand buffed to a mirror finish. Arm caps are molded in black.*

*Tip: List price based on highest fabric grade usage.*

*Tip: Contrasting option available only on 798-P and 796-P.*

Standard Includes		Required to Specify
<ul style="list-style-type: none"> <li>▶Need help? Product details, see <i>Coalesse Seating and Outdoor Specification Guide</i></li> </ul>	<ul style="list-style-type: none"> <li>• Frame: hardwood plywood assembled into unibody structures utilizing interlocking finger joinery</li> <li>• Cushioning:                             <ul style="list-style-type: none"> <li>- back: multiple laminations of high-density polyurethane foam over an elastic sheet suspension system for lumbar support</li> <li>- seat: closed cell, contour molded urethane foam</li> </ul> </li> <li>• Upholstery:                             <ul style="list-style-type: none"> <li>- seams are double needle stitched with seam binding for extended durability</li> <li>- unique wrap around welt detail and is cut from the same fabric as specified on chair</li> </ul> </li> <li>• Arms: resilient self-skinned urethane molded around carbon steel armature, black or aluminum arm with urethane cap, if selected</li> <li>• Chair controls: tilt-swivel with tilt tension, pneumatic height adjustment, and tilt lockout</li> <li>• Bases: five star black resin</li> <li>• Casters: black hooded dual wheel</li> </ul>	<ol style="list-style-type: none"> <li>1 Style number</li> <li>2 Number of fabrics if contrasting fabric style number is selected</li> <li>3 Fabric or leather color number for upholstery on seat and back</li> <li>4 Options, if selected (see below)</li> </ol> ▶See <i>Surface Materials</i> , page 196.

Options	Price	Required to Specify
<b>Surface Materials</b>		
<b>Welt detail</b>		
• Contrasting fabric welt	+\$ 86	Specify with <i>contrasting fabric welt</i> and select fabric color number.
• Contrasting leather welt	+\$125	Specify with <i>contrasting leather welt</i> and select fabric color number.
<b>Contrasting fabric</b>		
• Contrasting fabric	+\$167 per fabric	Add suffix K to the style number and select fabric color number.
<b>Acrylic backer</b>		
• Conference, midback, and high back large chairs	+\$ 26	Specify with <i>acrylic backer</i> .
• High back large chair	+\$ 30	Specify with <i>acrylic backer</i> .
• Midback with pillow chairs	+\$ 43	Specify with <i>acrylic backer</i> .
• High back with pillow chairs	+\$ 45	▶See <i>Surface Materials</i> , page 196.
<b>Base</b>		
• Polished aluminum with black, hooded dual wheel casters	+\$ 88	Specify with <i>polished aluminum base</i> .
<b>Casters</b>		
• Soft wheel casters	+\$ 63	Specify with <i>soft casters</i> .
<b>Control</b>		
• Knee-tilt with pneumatic height adjustment and tilt lockout	+\$ 217	Specify with <i>knee-tilt</i> .

## Specification Information

Style Number	Base Prices														Leather Grades:		
	Fabric Grades:														COL	C	E
	COM	6	7	8	9	10	11	12	13	14							

### Conference Narrow/Narrow with Urethane Arms

795	\$1569	\$1566	\$1595	\$1621	\$1654	\$1693	\$1795	\$1873	\$1964	\$2139	\$1887	\$2867	\$3054
-----	--------	--------	--------	--------	--------	--------	--------	--------	--------	--------	--------	--------	--------

COM/yds = 2, COL/sq ft = 36

### Conference Narrow/Narrow with Aluminum Arms

795AU	\$2087	\$2084	\$2113	\$2139	\$2172	\$2211	\$2313	\$2391	\$2482	\$2657	\$2405	\$3385	\$3572
-------	--------	--------	--------	--------	--------	--------	--------	--------	--------	--------	--------	--------	--------

▶Specification Information, continued on next page



Overall: 26½"D 26½"W 36"-39"H  
 Inside: 18"D 20"W 18½"H  
 Seat: 18½"-21½"H  
 Arm: 25¾"-28¾"H

# Chord Conference Seating

DESIGN MICHAEL SHIELDS

► Specification Information, continued from previous page

## Specification Information

Style Number	Base Prices										Leather Grades:		
	Fabric Grades:										COL	C	E
	COM	6	7	8	9	10	11	12	13	14			

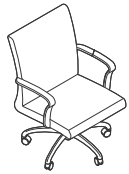

Overall: 26½"D 26½"W 37½"-40½"H  
 Inside: 19"D 21½"W 21½"H  
 Seat: 21½"H  
 Arm: 25¾"-28¾"H

### Mid Back with Urethane Arms

796	\$1756	\$1747	\$1776	\$1797	\$1831	\$1876	\$1982	\$2051	\$2151	\$2352	\$2074	\$3054	\$3232
-----	--------	--------	--------	--------	--------	--------	--------	--------	--------	--------	--------	--------	--------

COM/yds = 2, COL/sq ft = 36

### Mid Back with Aluminum Arms

796AU	\$2274	\$2265	\$2294	\$2315	\$2349	\$2394	\$2500	\$2569	\$2669	\$2870	\$2592	\$3572	\$3750
-------	--------	--------	--------	--------	--------	--------	--------	--------	--------	--------	--------	--------	--------

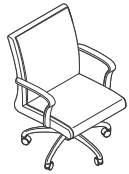

Overall: 26½"D 26½"W 37½"-40½"H  
 Inside: 18½"D 21½"W 19"H  
 Seat: 19"-22"H  
 Arm: 25¾"-28¾"H

### Mid Back/Pillow Upholstery with Urethane Arms

796-P	\$2109	\$2162	\$2196	\$2227	\$2298	\$2347	\$2514	\$2617	\$2758	\$2997	\$2439	\$3946	\$4221
-------	--------	--------	--------	--------	--------	--------	--------	--------	--------	--------	--------	--------	--------

COM/yds = 3, COL/sq ft = 54

### Mid Back/Pillow Upholstery with Aluminum Arms

796-PAU	\$2687	\$2680	\$2714	\$2745	\$2816	\$2865	\$3032	\$3135	\$3276	\$3515	\$2957	\$4464	\$4739
---------	--------	--------	--------	--------	--------	--------	--------	--------	--------	--------	--------	--------	--------

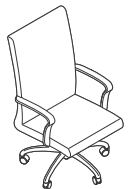

Overall: 26½"D 26½"W 46"-49"H  
 Inside: 18"D 20"W 18½"H  
 Seat: 18½"-21½"H  
 Arm: 25¾"-28¾"H

### High Back Narrow/Narrow with Urethane Arms

797	\$2176	\$2173	\$2207	\$2228	\$2261	\$2296	\$2402	\$2480	\$2571	\$2837	\$2494	\$3259	\$3444
-----	--------	--------	--------	--------	--------	--------	--------	--------	--------	--------	--------	--------	--------

COM/yds = 2, COL/sq ft = 36

### High Back Narrow/Narrow with Aluminum Arms

797AU	\$2694	\$2691	\$2725	\$2746	\$2779	\$2814	\$2920	\$2998	\$3089	\$3355	\$3012	\$3777	\$3962
-------	--------	--------	--------	--------	--------	--------	--------	--------	--------	--------	--------	--------	--------

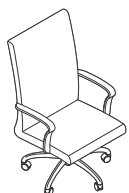

Overall: 26½"D 26½"W 46"-49"H  
 Inside: 19"D 21½"W 18½"H  
 Seat: 18½"-21½"H  
 Arm: 25¾"-28¾"H

### High Back/Large Scale with Urethane Arms

798	\$2203	\$2190	\$2219	\$2245	\$2278	\$2313	\$2419	\$2497	\$2588	\$2858	\$2520	\$3269	\$3454
-----	--------	--------	--------	--------	--------	--------	--------	--------	--------	--------	--------	--------	--------

COM/yds = 2, COL/sq ft = 44

### High Back/Large Scale with Aluminum Arms

798AU	\$2721	\$2708	\$2737	\$2763	\$2796	\$2831	\$2937	\$3015	\$3106	\$3376	\$3038	\$3787	\$3972
-------	--------	--------	--------	--------	--------	--------	--------	--------	--------	--------	--------	--------	--------

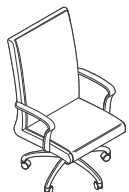

Overall: 26½"D 26½"W 46"-49"H  
 Inside: 19"D 21½"W 19"H  
 Seat: 19"-22"H  
 Arm: 26¾"H-28¾"H

### High Back/Large Scale with Pillow Upholstery with Urethane Arms

798-P	\$2359	\$2342	\$2380	\$2417	\$2488	\$2537	\$2692	\$2807	\$2948	\$3211	\$2629	\$4127	\$4401
-------	--------	--------	--------	--------	--------	--------	--------	--------	--------	--------	--------	--------	--------

COM/yds = 3, COL/sq ft = 66

### High Back/Large Scale with Pillow Upholstery with Aluminum Arms

798-PAU	\$2877	\$2860	\$2898	\$2935	\$3006	\$3055	\$3210	\$3325	\$3466	\$3729	\$3147	\$4645	\$4919
---------	--------	--------	--------	--------	--------	--------	--------	--------	--------	--------	--------	--------	--------

# SW\_1 Conference Seating

DESIGN SCOTT WILSON & MINIMAL

*Tip: For Customer's Own Material or Leather, see necessary requirements, important processing instructions, and ordering information.*  
 ▶ Page 198

	Standard Includes	Required to Specify
▶ Need help? Product details, see <i>Coalesse Seating and Outdoor Specification Guide</i>	<ul style="list-style-type: none"> <li>• Seat: fabric or leather</li> <li>• Back: knit</li> <li>• Base: 8040 Aluminum Matte Polished</li> <li>• Frame: steel tube</li> <li>• Glides on conference chair with 4-star base, if selected: aluminum with non marring plastic insert</li> <li>• Casters on conference chair with 5-star base, if selected: dual wheel hard casters, black only</li> <li>• Swivel return mechanism on conference chair with 4-star base, if selected</li> <li>• Swivel mechanism on conference chair with 5-star base, if selected</li> </ul>	1 Style number 2 Upholstery color number for seat 3 Knit color number for back 4 Options, if selected (see below) ▶ See <i>Surface Materials</i> , page 196

	Options	Price	Required to Specify
<b>Surface Materials</b>	<ul style="list-style-type: none"> <li>• Contrasting fabric</li> </ul>	+\$167	Specify with <i>contrasting fabric</i> and select fabric color number.
	<b>Acrylic backer</b> <ul style="list-style-type: none"> <li>• Backer</li> </ul>	+\$ 42	Specify with <i>acrylic backer</i> . ▶ See <i>Surface Materials</i> , page 196
<b>Mechanism</b>	<ul style="list-style-type: none"> <li>• Full swivel (omit swivel-return feature)</li> </ul>	No cost	Specify with <i>swivel-only mechanism</i> .
<b>Casters</b>	<ul style="list-style-type: none"> <li>• Black soft casters</li> <li>• Hard black casters with polished aluminum body</li> <li>• Soft black casters with polished aluminum body</li> </ul>	+\$ 34 +\$ 94 +\$128	Specify with <i>soft casters</i> . Specify with <i>hard polished aluminum casters</i> . Specify with <i>soft polished aluminum casters</i> .
<b>Related Products</b>	<ul style="list-style-type: none"> <li>• Collaborative and conference tables</li> <li>• Occasional tables</li> <li>• Lounge seating</li> </ul>		▶ See <i>GSA Volume 5b Specification Guide</i> . ▶ See <i>GSA Volume 5b Specification Guide</i> . ▶ Page 126

## Specification Information

Style Number	Base Prices											Leather Grades:		
	Fabric Grades:											COL	C	E
	COM	6	7	8	9	10	11	12	13	14				

### Conference Chair with 4-Star Base

<b>COW413</b>	Seat	\$2603	\$2603	\$2611	\$2626	\$2665	\$2693	\$2726	\$2747	\$2785	\$2840	\$2674	\$ 2991	\$3035
	Upper back	+\$ 99	+\$ 99	+\$119	+\$149	+\$250	+\$312	+\$386	+\$438	+\$527	+\$651	+\$263	+\$1000	+\$1111
COM/yds = 3, COL/sq ft = 60														

### Conference Chair with 5-Star Base

<b>COW415</b>	Seat	\$2603	\$2603	\$2611	\$2626	\$2665	\$2693	\$2726	\$2747	\$2785	\$2840	\$2674	\$ 2991	\$3035
	Upper back	+\$ 99	+\$ 99	+\$119	+\$149	+\$250	+\$312	+\$386	+\$438	+\$527	+\$651	+\$263	+\$1000	+\$1111



Overall: 25¼"D 28"W 31½"H  
 Seat: 18"H  
 Arm: 25¼"H



Overall: 25¼"D 28"W 29½"H-33"H  
 Seat: 16¼"H-19¾"H  
 Arm: 23½"H-27"H

# SW\_1 Conference Seating Multi-Fabric Diagram

DESIGN SCOTT WILSON & MINIMAL

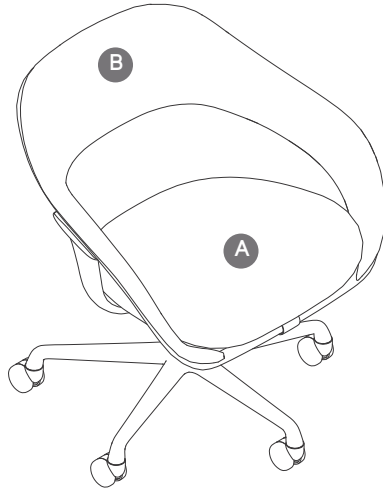

TO: \_\_\_\_\_

FROM: \_\_\_\_\_

DATE: \_\_\_\_\_

FAX...888.413.5161

**A** Seat: \_\_\_\_\_  
\_\_\_\_\_

**B** Arms/Back: \_\_\_\_\_  
\_\_\_\_\_

Contrasting fabric charges will apply. List price based on highest grade textile specified.

*Contrasting upcharge for each contrasting textile pricing based on highest grade textile specified. See specifying for contrasting upcharge.*

Specify Model below:

COW413 Conference Chair with 4-Star Base

COW415 Conference Chair with 5-Star Base





# Occasional Tables

Await	178
Enea Lottus	179
Sebastopol Occasional Tables	184
Trees	185

# Await Occasional Tables

DESIGN E00S

Standard Includes		Required to Specify
<ul style="list-style-type: none"> <li>▶ Need help?</li> <li>Product details, see <i>Coalesse Tables, Storage, and Accessories Specification Guide</i></li> </ul>	<ul style="list-style-type: none"> <li>• Freestanding table frame: 4142 Platinum Gloss</li> <li>• Top: High-Pressure Laminate top with matching 3 mm edge band</li> <li>• Glass top:                             <ul style="list-style-type: none"> <li>- 1/2" thick</li> <li>- Radiused edges</li> </ul> </li> </ul>	<ol style="list-style-type: none"> <li>1 Style number</li> <li>2 Laminate top and tablets, if selected:                             <ul style="list-style-type: none"> <li>2730 Arctic White</li> <li>2746 Black</li> <li>290N North Sea</li> </ul> </li> <li>3 Glass color number for top, if selected</li> </ol> <p>▶ See <i>Coalesse Surface Materials Reference Guide</i>.</p>

Related Products	
<ul style="list-style-type: none"> <li>• Lounge seating</li> <li>• Connector benches</li> </ul>	<ul style="list-style-type: none"> <li>▶ Page 40</li> <li>▶ Page 36</li> </ul>

### Specification Information

Style Number	Prices				
	Top Surface:				
	Laminate	Absolute Clear Green Glass	Absolute Clear Glass	Acid Etched 6511	Absolute Colored Glass

### Round, Low, Freestanding Table

46-T1	\$1463	\$1746	\$1778	\$1778	\$2011
-------	--------	--------	--------	--------	--------

### Round, High, Freestanding Table

46-T2	\$1909	\$2192	\$2224	\$2224	\$2457
-------	--------	--------	--------	--------	--------

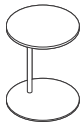

Overall: 15 3/4" Dia. 19"H



Overall: 15 3/4" Dia. 25"H

# Enea Lottus Occasional Tables

DESIGN LIEVORE ALTHERR MOLINA

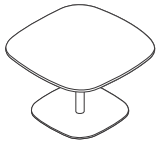

## Standard Includes

- Top: laminate or wood veneer with 1/2" thick phenolic core
- Base and frame: steel tubing and base
- Glides: non-skid

## Required to Specify

- 1 Style number
- 2 Laminate or wood veneer color number for top
  - ▶ See Veneer Matrix, page 213
- 3 Base/frame finish:
  - 4016 White Gloss
  - 4017 Black Gloss
  - 4217 Brown
  - 4218 Platinum Silver
  - ▶ See *Surface Materials*, page 196.

## Specification Information

Dimensions			Style Number	Prices				
D	W	H		Top Surface:				
				Laminate	Composite Veneer 1	Composite Veneer 2	Wood 1	Wood 2
30"	30"	18"	COEL1830	\$1746	\$1953	\$2107	\$1953	\$2107
36"	36"	18"	COEL1836	\$2030	\$2275	\$2466	\$2275	\$2466
42"	42"	18"	COEL1842	\$2472	\$2700	\$2917	\$2700	\$2917

# Enea Lottus Conference Tables

DESIGN LIEVORE ALTHERR MOLINA



### Standard Includes

- Top: laminate or wood veneer with 1/2" thick phenolic core
- Base and frame: steel tubing and base
- Glides: non-skid

### Required to Specify

- 1 Style number
- 2 Laminate or wood veneer color number for top  
▶ See Veneer Matrix, page 213
- 3 Base/frame finish:  
4016 White Gloss  
4017 Black Gloss  
4217 Brown  
4218 Platinum Silver  
▶ See *Surface Materials*, page 196.

### Specification Information

Dimensions			Style Number	Prices				
D	W	H		Top Surface:				
				Laminate	Composite Veneer 1	Composite Veneer 2	Wood 1	Wood 2
30"	30"	30"	COEL3030	\$1824	\$2031	\$2189	\$2031	\$2189
36"	36"	30"	COEL3036	\$2104	\$2349	\$2545	\$2349	\$2545
42"	42"	30"	COEL3042	\$2542	\$2776	\$2995	\$2776	\$2995

# Enea Lottus Café Counter Height Tables

DESIGN LIEVORE ALTHERR MOLINA

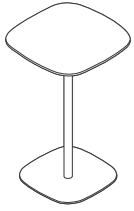

### Standard Includes

- Top: laminate or wood veneer with 1/2" thick phenolic core
- Base and frame: steel tubing and base
- Glides: non-skid

### Required to Specify

- 1 Style number
- 2 Laminate or wood veneer color number for top  
▶ See Veneer Matrix, page 213
- 3 Base/frame finish:  
4016 White Gloss  
4017 Black Gloss  
4217 Brown  
4218 Platinum Silver  
▶ See *Surface Materials*, page 196.

### Specification Information

Dimensions			Style Number	Prices				
D	W	H		Top Surface:				
				Laminate	Composite Veneer 1	Composite Veneer 2	Wood 1	Wood 2
24"	24"	36"	COEL3624	\$1512	\$1640	\$1771	\$1640	\$1771
30"	30"	36"	COEL3630	\$1871	\$2083	\$2245	\$2083	\$2245
36"	36"	36"	COEL3636	\$2157	\$2402	\$2602	\$2402	\$2602
42"	42"	36"	COEL3642	\$2590	\$2824	\$3047	\$2824	\$3047

Occasional Tables

# Enea Lottus Café Bar Height Tables

DESIGN LIEVORE ALTHERR MOLINA

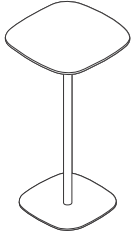

Standard Includes	Required to Specify
-------------------	---------------------

- Top: laminate or wood veneer with 1/2" thick phenolic core
- Base and frame: steel tubing and base
- Glides: non-skid

- 1 Style number
- 2 Laminate or wood veneer color number for top  
▶ See Veneer Matrix, page 213
- 3 Base/frame finish:  
4016 White Gloss  
4017 Black Gloss  
4217 Brown  
4218 Platinum Silver  
▶ See *Surface Materials*, page 196.

Specification Information									
Dimensions			Style Number	Prices					
D	W	H		Top Surface:					
			Laminate		Composite Veneer 1	Composite Veneer 2	Wood 1	Wood 2	
24"	24"	42"	COEL4224	\$1553	\$1686	\$1822	\$1686	\$1822	
30"	30"	42"	COEL4230	\$1917	\$2124	\$2289	\$2124	\$2289	
36"	36"	42"	COEL4236	\$2196	\$2441	\$2643	\$2441	\$2643	
42"	42"	42"	COEL4242	\$2722	\$2956	\$3189	\$2956	\$3189	

# Enea Lottus Rectangular Tables

DESIGN LIEVORE ALTHERR MOLINA

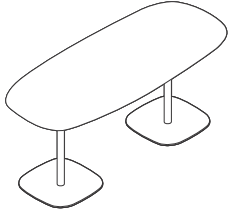

### Standard Includes

- Top: laminate or wood veneer with 1/2" thick phenolic core
- Base and frame: steel tubing and base
- Glides: non-skid

### Required to Specify

- 1 Style number
- 2 Laminate or wood veneer color number for top  
▶ See Veneer Matrix, page 213
- 3 Base/frame finish:  
4016 White Gloss  
4017 Black Gloss  
4217 Brown  
4218 Platinum Silver  
▶ See *Surface Materials*, page 196.

### Specification Information

Dimensions			Style Number	Prices				
D	W	H		Top Surface:				
				Laminate	Composite Veneer 1	Composite Veneer 2	Wood 1	Wood 2
30"	72"	30"	COEL303072	\$4104	\$4618	\$4988	\$4618	\$4988
30"	72"	36"	COEL363072	\$4195	\$4709	\$5084	\$4709	\$5084
30"	72"	42"	COEL423072	\$4285	\$4799	\$5181	\$4799	\$5181

Occasional Tables

# Sebastopol Occasional Tables

DESIGN EMILIA BORGTHORSDDOTTIR

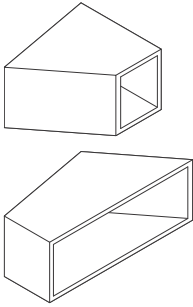

*Tip: Optional grommet to accept PowerPod can be specified in milk white or black plastic.*

*Tip: If a grommet is specified with a PowerPod and the table is over a floor core, the floor core outlet cannot be flush to the floor, because the plug end will not allow the PowerPod to sit in the grommet. If the floor core is flush to the floor and the grommet and PowerPod are required, the table either cannot be set over the floor core, or a special plinth base will be required. Consult your specials representative for additional information on the plinth base.*

Standard Includes	Required to Specify
-------------------	---------------------

- |   |  |
|---|--|
| <ul style="list-style-type: none"> <li>▶ Need help? Product details, see <i>Coalesse Seating and Outdoor Specification Guide</i></li> </ul> | <ul style="list-style-type: none"> <li>• Exterior surface: veneer grade 1, oak, or walnut</li> <li>• Interior surface: glossy laminate</li> <li>• Glides: concealed adjustable glide with non-marking nylon pad</li> </ul> |
|---|--|

- |   |
|---|
| <ol style="list-style-type: none"> <li>1 Style number</li> <li>2 Exterior surface wood finish number</li> <li>3 Interior surface glossy laminate:                             <ul style="list-style-type: none"> <li>2001 Smoky White</li> <li>2002 Studio Gray</li> <li>2003 Wrought Iron</li> <li>2004 Black Pearl</li> <li>2005 Liberty Red</li> </ul> </li> <li>4 Options, if selected (see below)</li> </ol> <p>▶ See <i>Coalesse Surface Materials Reference Guide</i>.</p> |
|---|

Options	Price	Required to Specify
---------	-------	---------------------

- |   |        |   |
|---|--------|---|
| <b>Grommet</b> <ul style="list-style-type: none"> <li>• Grommet to accept PowerPod</li> </ul> | +\$157 | Specify <i>with grommet</i> and select finish color number either in milk white or black plastic. |
|---|--------|---|

Specification Information							
---------------------------	--	--	--	--	--	--	--

Dimensions			Style Number	Base Prices			
D	W	H		Top Surface:			
				Composite Veneer Grade 1	Composite Veneer Grade 2	Wood Grade 1	Wood Grade 2

### 16" High Tables

23"	27"	16"	COEB2723L	\$1732	\$1867	\$1732	\$1867
18"	41"	16"	COEB4118L	\$2050	\$2210	\$2050	\$2210

### 22" High Tables

23"	27"	22"	COEB2723H	\$1890	\$2039	\$1890	\$2039
18"	41"	22"	COEB4118H	\$2207	\$2380	\$2207	\$2380



# Trees Occasional Tables

DESIGN NORMAN DIEKMAN

*Tip: Tops come in the same wood and finish but with smooth surface.*

Standard Includes		Required to Specify
<ul style="list-style-type: none"> <li>▶ Need help? Product details, see <i>Coalesse Tables, Storage, and Accessories Specification Guide</i></li> </ul>	<ul style="list-style-type: none"> <li>• Embossed wood is created under high pressure to add dimensionality and texture on all sides of the table                             <ul style="list-style-type: none"> <li>- Interior frame is constructed from a combination of engineered lumber and hardwood veneers</li> <li>- Embossed hardwood veneer is applied to all vertical and slanted surfaces</li> <li>- Embossed wood in Natural EWNT</li> </ul> </li> </ul>	1 Style number 2 Options, if selected (see below)

Options	Price	Required to Specify
<b>Surface Materials</b> <ul style="list-style-type: none"> <li>• Bevel high embossed wood (Model 70-C-TPM) available in medium brown EWMB</li> <li>• Bevel medium embossed wood (Model 70-D-TPM) available in medium brown EWMB</li> </ul>	+\$96  +\$96	Specify with <i>medium brown</i> .  Specify with <i>medium brown</i> .

### Specification Information

Dimensions			Style	Base
D	W	H	Number	Price

Bevel High–Embossed Wood Table				
15½"	14"	23"	70-C-TPM	\$3368

Bevel Medium–Embossed Wood Table				
15½"	14"	19¾"	70-D-TPM	\$3282

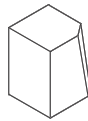
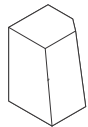



# Outdoor

  
**Emu Advanced Collection**

Emu Heaven	188
Emu Round	192

# Emu Advanced Collection Emu Heaven – Seating

DESIGN JEAN-MARIE MASSAUD

*Tip: All chairs can stack four high.*

*Tip: The following powder coat paint finishes are available with an upcharge, as shown at right: 4251 Emu Brown, 4257 Antique Iron, 7272 Blue, 7273 Green, 7294 Emu Grey/Green, 7296 Emu Taupe, 7297 Emu Corten, and 7391 Emu Poppy.*

Standard Includes	Required to Specify
-------------------	---------------------

- |  |  |   |
|--|--|---|
| <p>► Need help? Product details, see <i>Coalesse Seating and Outdoor Specification Guide</i></p> | <ul style="list-style-type: none"> <li>• Frame: hand crafted woven steel mesh</li> <li>• Finish: outdoor grade powder coat paint</li> <li>• Glides: nylon</li> </ul> | <ol style="list-style-type: none"> <li>1 Style number</li> <li>2 Powder coat color for frame:<br/>7234 Emu Black<br/>7271 Emu White</li> <li>3 Options, if selected (see below)</li> </ol> <p>► See <i>Surface Materials</i>, page 196.</p> |
|--|--|---|

Options	Price	Required to Specify
---------	-------	---------------------

<b>Surface Materials</b>	<p><b>Other Emu paint (cost per pack)</b></p> <ul style="list-style-type: none"> <li>• Pouf table base +\$148</li> <li>• Chair +\$177</li> <li>• Arm chair +\$177</li> <li>• Lounge chair +\$235</li> </ul>	<p>Specify paint color number. Specify paint color number. Specify paint color number. Specify paint color number.</p>
--------------------------	---	--

Specification Information					
---------------------------	--	--	--	--	--

Dimensions		H	Style Number	Quantity	Base Price
D	W				

### Chairs

23¼"	24½"	31"	CO2485	2	\$1303
------	------	-----	--------	---	--------



Seat height: 17¾"  
Seat depth: 16⅞"

### Arm Chairs

24"	27¼"	31"	CO2486	2	\$1491
-----	------	-----	--------	---	--------



Seat height: 17¾"  
Seat depth: 16⅞"  
Arm height: 26¾"

### Lounge Chairs

30¾"	37"	27¼"	CO2487	2	\$2502
------	-----	------	--------	---	--------

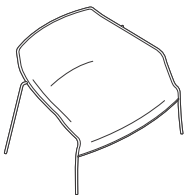

Seat height: 13¾"  
Seat depth: 18½"  
Arm height: 20½"

► Specification Information, continued on next page

# Emu Advanced Collection Emu Heaven – Seating

DESIGN JEAN-MARIE MASSAUD

► Specification Information, continued from previous page

**Specification Information**

Dimensions		Style Number	Quantity	Base Price
Dia.	H			

**Pouf/Side Table Base**

17 <sup>3</sup> / <sub>4</sub> "	18 <sup>1</sup> / <sub>2</sub> "	CO2495	1	\$561
----------------------------------	----------------------------------	--------	---	-------



**Glass Top for use with Pouf**

17 <sup>3</sup> / <sub>4</sub> "		CO2495V	1	\$262
----------------------------------	--	---------	---	-------



*Tip: CO2495 pouf must be ordered with glass top, specified separately.*

## Vases

**Standard Includes** **Required to Specify**

- |  |   |                     |
|--|---|---------------------|
| <p>► Need help?<br/>Product details, see <i>Coalesse Seating and Outdoor Specification Guide</i></p> | <ul style="list-style-type: none"> <li>Vase: handcrafted woven steel mesh</li> <li>Finish: 7271 Emu White outdoor grade powder coat paint</li> <li>Planter insert: white plastic</li> </ul> | <p>Style number</p> |
|--|---|---------------------|

**Specification Information**

Dimensions		Style Number	Price
Dia.	H		

**Low Vase**

23 <sup>1</sup> / <sub>2</sub> "	40 <sup>1</sup> / <sub>2</sub> "	CO2498	\$1817
----------------------------------	----------------------------------	--------	--------

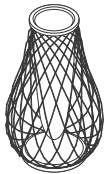

**High Vase**

26 <sup>3</sup> / <sub>4</sub> "	64 <sup>1</sup> / <sub>4</sub> "	CO2497	\$2562
----------------------------------	----------------------------------	--------	--------

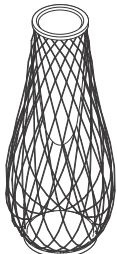

**Planter insert dimensions:**  
Low: 36" H x 13<sup>1</sup>/<sub>2</sub>" Dia  
High: 33" H x 13<sup>1</sup>/<sub>2</sub>" Dia

Outdoor

# Emu Advanced Collection Emu Heaven – Tables

DESIGN JEAN-MARIE MASSAUD

*Tip: Tables require glass top, specified separately.*

*Tip: The following powder coat paint finishes are available with an upcharge, as shown at right: 4251 Emu Brown, 4257 Antique Iron, 7272 Blue, 7273 Green, 7294 Emu Grey/Green, 7296 Emu Taupe, 7297 Emu Corten, and 7391 Emu Poppy.*

Standard Includes		Required to Specify
<ul style="list-style-type: none"> <li>Need help? Product details, see <i>Coalesse Seating and Outdoor Specification Guide</i></li> </ul>	<ul style="list-style-type: none"> <li>Frame: interwoven steel rods</li> <li>Finish: outdoor grade powder coat paint</li> <li>Glides: nylon</li> <li>Top: tempered glass</li> </ul>	<ol style="list-style-type: none"> <li>Style number</li> <li>Powder coat color for base: 7271 Emu White</li> <li>Glass top color number for glass top</li> <li>Options, if selected (see below)</li> </ol> <p>► See <i>Surface Materials</i>, page 196.</p>

Options	Price	Required to Specify
<b>Other Emu paint</b> <ul style="list-style-type: none"> <li>Round table bases</li> <li>Low table base</li> </ul>	+\$235 +\$235	Specify paint color number. Specify paint color number.

### Specification Information

Dimensions	Style	Base
Dia. H	Number	Price

### Round Table Bases

For use with 31½" CO2493V Glass Top

31½"	29½"	CO2493	\$1333
------	------	--------	--------



Top of base: 27½" Diameter  
Bottom of base: 17¾" Diameter

For use with 47¼" CO2494V Glass Top

47¼"	43⅓"	CO2494	\$2749
------	------	--------	--------

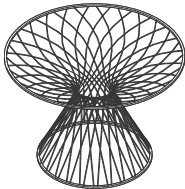

Top of base: 43⅓" Diameter  
Bottom of base: 27½" Diameter

### Low Table Base

43⅓"	15¼"	CO2496	\$2066
------	------	--------	--------

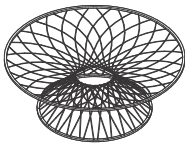

Top of base: 43⅓" Diameter  
Bottom of base: 27½" Diameter

### Glass Tops

For use with 27½" CO2493 Round Table Base

31½"	¼"	CO2493V	\$ 516
------	----	---------	--------



For use with 43⅓" CO2494 Round or CO2496 Low Table Base

47¼"	¼"	CO2494V	\$ 780
------	----	---------	--------



Coalesse SIN 33721

# Emu Advanced Collection

Emu Heaven – Tables

DESIGN JEAN-MARIE MASSAUD

Outdoor

# Emu Advanced Collection Emu Round – Seating

DESIGN CHRISTOPHE PILLET

*Tip: Stool and lounge stacks four high. Chair stacks eight high.*

*Tip: The following powder coat paint finishes are available with an upcharge, as shown at right: 7272 Blue, 7273 Green, 7294 Emu Grey/Green, 7296 Emu Taupe, 7297 Emu Corten, and 7391 Emu Poppy.*

### Standard Includes Required to Specify

- |  |   |   |
|--|---|---|
| <p>► Need help? Product details, see <i>Coalesse Seating and Outdoor Specification Guide</i></p> | <ul style="list-style-type: none"> <li>• Frame: metal mesh seat, crafted using a deep drawing technique, welded to a tubular steel frame</li> <li>• Finish: outdoor grade powder coat paint</li> <li>• Glides: nylon</li> </ul> | <ol style="list-style-type: none"> <li>1 Style number</li> <li>2 Powder coat color for frame:<br/>4251 Emu Brown<br/>4257 Antique Iron<br/>7234 Emu Black<br/>7271 Emu White</li> <li>3 Options, if selected (see below)</li> </ol> |
|--|---|---|

### Options Price Required to Specify

<p><b>Surface Materials</b></p>	<p><b>Acrylic backer</b></p> <ul style="list-style-type: none"> <li>• Indoor stool cushions only +\$ 11</li> <li>• Indoor chair cushions only +\$ 18</li> <li>• Indoor lounge cushions only +\$ 30</li> <li>• Indoor pillow cushions only +\$ 6</li> </ul>	<p></p>	<p>Specify with acrylic backer. Specify with acrylic backer. Specify with acrylic backer. Specify with acrylic backer.</p> <p>► See <i>Surface Materials</i>, page 196.</p>
	<p><b>Other Emu paint (cost per pack)</b></p> <ul style="list-style-type: none"> <li>• Stool +\$ 177</li> <li>• Armless chair +\$235</li> <li>• Arm chair +\$235</li> <li>• Lounge +\$235</li> </ul>		<p>Specify paint color number. Specify paint color number. Specify paint color number. Specify paint color number.</p>

### Specification Information

Dimensions	Style	Quantity	Base
D    W    H	Number		Price

#### Stools

20½"	22¾"	39¼"	CO2467	2	\$1392
------	------	------	--------	---	--------

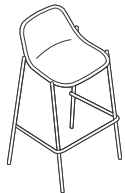

Seat height: 28"

#### Armless Chairs

23¼"	24¾"	32"	CO2465	4	\$1778
------	------	-----	--------	---	--------



Seat height: 17¾"

#### Arm Chairs

23¼"	24¾"	32"	CO2466	4	\$1949
------	------	-----	--------	---	--------



Seat height: 17¾"  
Arm height: 26"

#### Lounges

34¼"	36¼"	33"	CO2469	2	\$1898
------	------	-----	--------	---	--------

► Specification Information, continued on next page



Seat height: 15"  
Seat depth: 22½"



# Emu Advanced Collection Emu Round – Seating

DESIGN CHRISTOPHE PILLET

*Tip: All cushions come in quantity of one.*

*Tip: Cushions are one piece with a slit to allow for water drainage.*



Overall: 3/4"D x 22"W x 28"H



Overall: 3/4"D x 18"W x 22 1/2"H

*Tip: Chair cushion for use on chair and arm chair.*



Overall: 3/4"D x 34"W x 40"H



Overall: 4 1/4"D x 17 1/4"W x 10 1/2"H

*Tip: Lounge pillow is for use with Heaven and Round Lounge chairs.*

► Specification Information, continued from previous page

## Specification Information

Style Number	Base Prices										Leather Grades:		
	Fabric Grades:										COL	C	E
	COM	6	7	8	9	10	11	12	13	14			

### Stool Cushions

#### Outdoor Cushion

CO2467C	\$444	N.A.	N.A.	N.A.	N.A.	N.A.	\$525	N.A.	\$ 543	\$ 620	N.A.	N.A.	N.A.
---------	-------	------	------	------	------	------	-------	------	--------	--------	------	------	------

#### Indoor Cushion

CO2467B	\$444	\$444	\$455	\$472	\$523	\$561	\$599	\$ 628	\$ 679	\$ 748	\$589	\$1187	\$1304
---------	-------	-------	-------	-------	-------	-------	-------	--------	--------	--------	-------	--------	--------

COM/yds = 1 1/4, COL/sq ft = 28

### Chair Cushions

#### Outdoor Cushion

CO2465C	\$463	N.A.	N.A.	N.A.	N.A.	N.A.	\$565	N.A.	\$ 588	\$ 683	N.A.	N.A.	N.A.
---------	-------	------	------	------	------	------	-------	------	--------	--------	------	------	------

#### Indoor Cushion

CO2465B	\$463	\$463	\$475	\$496	\$560	\$602	\$650	\$ 686	\$ 744	\$ 825	\$597	\$1326	\$1464
---------	-------	-------	-------	-------	-------	-------	-------	--------	--------	--------	-------	--------	--------

COM/yds = 1 1/2, COL/sq ft = 33

### Lounge Cushions and Pillows

#### Outdoor Cushion

CO2469C	\$607	N.A.	N.A.	N.A.	N.A.	N.A.	\$769	N.A.	\$ 805	\$ 955	N.A.	N.A.	N.A.
---------	-------	------	------	------	------	------	-------	------	--------	--------	------	------	------

#### Indoor Cushion

CO2469B	\$607	\$634	\$654	\$689	\$797	\$867	\$946	\$1004	\$1102	\$1242	\$725	\$1980	\$2210
---------	-------	-------	-------	-------	-------	-------	-------	--------	--------	--------	-------	--------	--------

COM/yds = 2 1/2, COL/sq ft = 55

#### Outdoor Pillow

CO2488C	\$267	N.A.	N.A.	N.A.	N.A.	N.A.	\$296	N.A.	\$ 306	\$ 351	N.A.	N.A.	N.A.
---------	-------	------	------	------	------	------	-------	------	--------	--------	------	------	------

#### Indoor Pillow

CO2488B	\$267	\$249	\$254	\$265	\$295	\$315	\$339	\$353	\$ 383	\$ 422	\$407	\$ 730	\$ 796
---------	-------	-------	-------	-------	-------	-------	-------	-------	--------	--------	-------	--------	--------

COM/yds = 3/4, COL/sq ft = 17

# Emu Advanced Collection Emu Round – Tables

DESIGN CHRISTOPHE PILLET

*Tip: The following powder coat paint finishes are available with an upcharge, as shown at right: 7272 Blue, 7273 Green, 7294 Emu Grey/Green, 7296 Emu Taupe, 7297 Emu Corten, and 7391 Emu Poppy.*

Standard Includes	Required to Specify
<p>► Need help? Product details, see <i>Coalesse Seating and Outdoor Specification Guide</i></p> <ul style="list-style-type: none"> <li>• Frame: table top and base are sheet metal with tubular steel mountings</li> <li>• Finish: outdoor grade powder coat paint</li> <li>• Glides: nylon</li> </ul>	<ol style="list-style-type: none"> <li>1 Style number</li> <li>2 Powder coat color for frame:                     <ul style="list-style-type: none"> <li>4251 Emu Brown</li> <li>4257 Antique Iron</li> <li>7234 Emu Black</li> <li>7271 Emu White</li> </ul> </li> <li>3 Options, if selected (see below)</li> </ol>

Options	Price	Required to Specify
<p><b>Other Emu paint</b></p> <ul style="list-style-type: none"> <li>• Square tables</li> <li>• Round table</li> <li>• Counter table</li> <li>• Side table</li> <li>• Rectangle table</li> </ul>	<ul style="list-style-type: none"> <li>+\$148</li> <li>+\$148</li> <li>+\$148</li> <li>+\$148</li> <li>+\$177</li> </ul>	<ul style="list-style-type: none"> <li>Specify paint color number.</li> <li>Specify paint color number.</li> <li>Specify paint color number.</li> <li>Specify paint color number.</li> <li>Specify paint color number.</li> </ul>

### Specification Information

Dimensions			Style	Base
D	W	H	Number	Price

#### Square Tables

23½"	23½"	29½"	CO2472	\$ 794
27½"	27½"	29½"	CO2471	\$ 936
31½"	31½"	29½"	CO2473	\$ 994

#### Round Table

35½" dia.		29½"	CO2470	\$1061
-----------	--	------	--------	--------

#### Rectangle Table

31½"	47½"	29½"	CO2474	\$1548
------	------	------	--------	--------

#### Counter Table

23½"	23½"	41¼"	CO2475	\$ 957
------	------	------	--------	--------

#### Side Table

31½"	31½"	16½"	CO2477	\$ 688
------	------	------	--------	--------

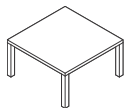
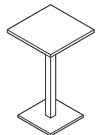
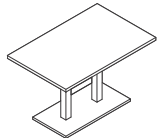
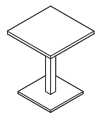

---

# Surface Materials

► For more detailed Coalesse surface material information, see the *Coalesse Surface Materials Reference Guide* or consult your Steelcase dealer.

<b>Surface Materials-Upholstery</b>	196
Customer's Own Material	198
Upholstery Matrix	200
<b>Surface Materials-Leather/Faux</b>	204
Cut Yardage Net Price List	206
Leather and Faux Leather Matrix	207
<b>Surface Materials-Wood</b>	208
Solid Wood Matrix	210
Veneer Matrix	212
<b>Surface Materials-Laminate</b>	213
High-Pressure Laminate Matrix	214
Laminate Edge Band Matrix	218
<b>Surface Materials-Glass</b>	220
Glass Matrix	221
<b>Surface Materials-Metal/Paint</b>	222
Metal/Paint Matrix	224
EMU Advanced Collection Paint Matrix	228
<b>Surface Materials-Miscellaneous</b>	229
Ordering	230
Care and Maintenance	232

# Surface Materials - Upholstery

## Upholstery

All Coalesse textiles are priced by grades. Some Coalesse fabrics can be treated for flame retardancy, contact Customer Service. All Coalesse products are handcrafted making each unique. Certain fabrics and leathers will appear loose and may differ from like products due to comfort wrinkles when upholstered.

A contrasting welt is available on some products. Consult Customer Service for yardage or square feet requirements and prices. All stripes will be applied vertically unless customer specifies otherwise. Loose cushions on Coalesse products are not fully upholstered (not reversible).

Designtex, Maharam, Steelcase, and select Luna fabrics are graded in our pricing. Simply order Coalesse products with Designtex, Maharam, Steelcase, and select Luna fabrics are graded in on Coalesse products; however, Coalesse does not stock fabrics and can only respond based on Designtex, Maharam, Steelcase, and select Luna fabrics lead times. For current grades, refer to Coalesse website: [www.Coalesse.com](http://www.Coalesse.com).

## Special Fabric Applications

### Backing

• Backing information is found on each product page. Select this option when ordering your product to have backing applied. Price varies by product according to yardage it requires.

*Tip: Prices subject to change without notice and an additional 2 week lead time will apply for 54" wide fabrics. Wider fabrics will require 4 week additional lead time. Check fabric database to determine if backing is required at [www.Coalesse.com](http://www.Coalesse.com).*

## Seating Upholstery

Coalesse fabrics are priced by grades from 6 through 14 and leathers C and E. Fabrics and leathers may be purchased separately as cut yardage, see page 438. All products are handcrafted, making each unique. Certain fabrics and leathers will appear loose and may differ from like products due to wrinkles when upholstered. A contrasting welt is available on some products. Consult Customer Service for yardage or square feet requirements for pricing.

All stripes will be applied vertically unless customer specifies otherwise. Loose cushions on Coalesse products are not fully upholstered (not reversible). Any Select Surface or COM textile should be reviewed with supplier to verify availability. In some cases a textile supplier may require minimums that exceed your furniture order requirements. In these situations, you will be contacted with an option to select a different textile or continue with your original textile selection as a COM-DTP. If you choose to continue with your textile selection as COM-DTP to allow you to order the minimum required, please ship only the textile needed to Coalesse for your furniture order.

## EMU Upholstery

**Applies to: EMU Advanced Collection Outdura Collection**

### Fabric Grade 6

5G30	Natural White
5G31	Kona
5G32	Sandstone
5G33	Cadet Grey
5G34	Stone
5G35	China Red
5G36	Cardinal Red
5G37	Solid Aquamarine
5G38	Canary
5G39	Pesto
5G41	Island Blue

## SW\_1 Knit

**Applies to: SW\_1 Collection**

5KG0	Stone
5KG1	Grey
5KG2	Brown
5KG3	Black
5KG4	Ivory
5KG5	Coal
5KG6	Garnet
5KG7	Golden
5KG8	Royal

## Lagunitas Knit

**Applies to: Lagunitas focus nook and lounge system**

### Grade 1

5K50	Stone
5K51	Grey
5K54	Black
5K58	Ivory
5K59	Coal

### Grade 2

5K52	Cement
5K53	Brown
5K55	Garnet
5K56	Golden
5K57	Royal
5K60	Glacier
5K61	Cadet
5K62	Grass
5K63	Forest
5K64	Amber
5K65	Terracotta
5K66	Crimson
5K67	Berry
5K68	Violet
5K69	Khaki

## Hexa Upholstery

**Applies to: Hosu**

### Fabric Grade 10

CL50	Dark Grey
CL51	Light Grey
CL52	Blue
CL55	Yellow
CL70	Saffron
CL71	Rose Quartz
CL72	Lagoon
CL73	Sea Salt
CL74	Steam
CL75	Ocean
CL76	Sage

## Fusion Upholstery

**Applies to: Hosu lounge and Lagunitas personal table**

### Fabric Grade 11

CL60	Caviar
CL62	Graphite
CL64	Steam*
CL80	Terracotta
CL81	Copper
CL82	Sage
CL83	Blue Ink
CL84	Blue Steel

\* Not available on Hosu

# Surface Materials - Steelcase Upholstery

## Steelcase Upholstery

Coalesse offers a select palette of Steelcase fabrics as standard. This provides the convenience of an integrated finish offering and ease of specification. See the Steelcase Standard Fabric Matrix for availability by product line. For a visual reference, please refer to the Steelcase Finish Library.

### Grade 6

#### Cogent: Connect

- 5S15 Coconut
- 5S16 Turmeric/Honey
- 5S17 Tangerine
- 5S18 Scarlet
- 5S19 Concord
- 5S21 Blue Jay
- 5S23 Wasabi
- 5S24 Nickel
- 5S25 Graphite
- 5S26 Licorice
- 5S27 Malt
- 5S28 Root Beer
- 5S93 Indigo/Blueprint
- 5S94 Lizard/Jungle
- 5S95 Sailor
- 5S96 Quicksilver
- 5S98 Canary
- 5S99 Lipstick/Merlot
- 5SD0 Royal Blue
- 5SD1 Aubergine
- 5SD2 Peacock
- 5SD3 Lagoon
- 5SD4 Saffron
- 5SD5 Citrine
- 5SD6 Rose Quartz
- 5SD7 Sea Salt
- 5SF3 Storm Cloud
- 5SF4 Olivine

#### Jacks

- 5B61 Taupe
- 5B62 Camel
- 5B64 Pewter
- 5B70 Midnight

#### Nitelights

- 5F66 Stone
- 5F67 Moon

#### Link

- 5A24 Blue
- 5A25 Navy
- 5A27 Black

### Grade 7

#### Dovetail by Designtex

- 5H39 Light Mocha
- 5H40 Pebble
- 5H41 Warm White
- 5H42 Sandstone
- 5H43 Honeycomb
- 5H44 Terra
- 5H45 Honeydew
- 5H46 Denim
- 5H47 Storm
- 5H48 Ice Blue
- 5H49 Aura
- 5H50 Darkest Grey

#### SoftNext

- 5H27 Obsidian
- 5H28 Foggy Night
- 5H29 Greystone
- 5H30 Mocha
- 5H31 Clay
- 5H32 Sandstone
- 5H33 Chalk
- 5H34 Midnight
- 5H35 Blue Mica
- 5H36 Jade
- 5H37 Burnt Umber
- 5H38 Cinnabar

#### Stand In

- 5621 Sleet
- 5622 Lunar
- 5623 Cyclone
- 5624 Eclipse
- 5625 Powder
- 5626 Chardonnay
- 5627 Graham
- 5628 Sediment
- 5629 Allspice
- 5630 Apple
- 5631 Lava
- 5632 Cayenne
- 5633 Plantain
- 5634 Parsley
- 5635 Scallion
- 5636 Atlantis
- 5691 Orca
- 5740 Burlap
- 5741 Porter
- 5742 Tusk
- 5743 Putty
- 5744 Blueberry
- 5745 Chartreuse
- 5746 Mango
- 5747 Sedona
- 5748 Juniper
- 5749 Peanut

#### New Black

- 5J08 Jack
- 5J09 James
- 5J12 Harley

### Grade 8

#### Billiard Multi-Use by Designtex

- 5H10 Bone
- 5H11 Poppy
- 5H12 Tangelo
- 5H13 Citrine/Citron
- 5H14 Avocado
- 5H15 Hunter
- 5H16 Indigo
- 5H17 Mallard
- 5H18 Teak
- 5H19 Cumulus
- 5H20 Pewter
- 5H21 Gunmetal
- 5H22 Ink
- 5H23 Rose Quartz
- 5H24 Sea Salt
- 5H25 Storm Cloud
- 5H26 Olivine

### Grade 9

#### Remix

- RE01 Rust
- RE03 Pebble
- RE04 Dark Chocolate
- RE06 Linen Beige
- RE08 Concrete
- RE09 Sky Blue
- RE10 Blue Jean
- RE11 Ivy Green
- RE13 Night Blue

#### Bo Peep

- 5G67 Bone
- 5G69 Brown Sugar
- 5G70 Chocolate
- 5G71 Candlelight
- 5G72 Honey Mustard
- 5G73 Marmalade
- 5G74 Picnic
- 5G75 Pinot
- 5G76 Bloom
- 5G77 Grapevine
- 5G78 Firefly
- 5G79 Artichoke
- 5G80 Serpent
- 5G81 Carolina
- 5G82 Blue Bonnet
- 5G83 Nautical
- 5G84 Gravel
- 5G85 Sharkskin
- 5G86 Kohl

# Customer's Own Material

## CUSTOMER'S OWN MATERIAL

Coalesse is pleased to cooperate with COM/COL selections. Prior to order placement for exact yardage requirements, a sample cutting of actual COM/COL must be submitted to Coalesse for approval only if fabric approval is not found in Coalesse fabric database. Identify the name and number of units on which the fabric/leather is to be applied. If COM has a repeat the sample should be large enough to show the entire repeat. Coalesse will not accept nor use any painted leathers. A painted leather is described as any suede or leather which is not aniline dyed with the same color throughout the thickness of the hide.

Even after preliminary approval, Coalesse reserves the right to reject COM/COL if necessary when the quality is not satisfactory for the item it is intended to be used on. Once COM/COL is accepted Coalesse assumes no responsibility for its overall appearance, flammability, normal durability, colorfastness, or any other quality, after upholstered on a Coalesse product.

## COALESSE STANDARD TO BUY PROGRAM

The Customer's Own Material (COM) Program offers the opportunity for customers to select fabrics that are not offered through the standard Coalesse surface materials program for use on our products. Through the COM program, Coalesse will test your materials for application on Coalesse products. Once approved, you can place your order. Coalesse will facilitate the entire ordering process and give you a production schedule. Coalesse will order the COM fabric directly from the textile manufacturer. For up-to-date information regarding fabric test results for all COM fabrics and details regarding yardage requirements for most Seating lines, visit the fabric database at [www.coalesse.com](http://www.coalesse.com).

## CUSTOMERS TO BUY SCHEDULING POLICY/COM/COL POLICY

COM/COL must be received at manufacturing location no later than 20 working days prior to the order scheduled delivery date. If COM/COL is not received in this time frame, scheduling will move the order's delivery date out to the best available ship date. Customer Service will notify the dealer via e-mail of the order's new scheduled delivery date. Project size order shipment may be affected due to size of order. If the COM/COL is received and the COM/COL requires backing, scheduling will move order out to best available ship date. Backing charges will apply. If COM/COL is received defective or short yardage/sq. ft., the replacement COM/COL order must be received within 3 days to maintain scheduled delivery date on order. It is the responsibility of the dealer to advise Coalesse on what to do with defective materials. In addition, customers may request Coalesse to order for COM/COL materials.

## SQUARE FOOTAGE/ YARDAGE REQUIREMENTS

COM and COL price includes application of Customer's Own Material or Leather to frames. All COM and COL should be shipped freight prepaid to designated manufacturing location. Labels will be provided by your Customer Service representative to ensure clear textile identification.

Please have customers send COM/COL and add TAG: COM/ COL.

COM and COL must be identified as follows to prevent order delays:

1. Name and address (Should match purchase order)
2. Your furniture purchase order number/sales order
3. Style number to which fabric is to be applied
4. Supplier name and fabric name, number, and color

COL hides must be rolled for shipment to manufacturing location in a neat manner, avoiding creases and excessive roll marks. All leathers will be rejected if sent in a folded manner.

To determine COL square footage, see COL requirements for each product. Square footage requirements are based on an average hide size of 45-50 square feet of clean, usable leather. If the COL has a smaller average hide size, please consult Customer Service for quotation. Please note, leather is a natural product and all square footage requirements are estimations. The shape of the COL hides supplied and the usable, clean square footage may make it necessary for us to request more leather after COL is received.

Yardage requirements shown are based on 54" width plain material. If fabric design requires vertical/top out, Customer Service should be consulted for additional yards required. If fabric is under 54", refer to fabric database at [www.coalesse.com](http://www.coalesse.com).

## EXCESS COM/COL POLICY

All excess COM/COL will be disposed of after order is completed unless prior arrangements have been made with Coalesse Customer Service. Fedex account number and address to ship to must be referenced. Excess WILL NOT be returned with shipment of furniture.

# Customer's Own Material

## Cutting Direction Guidelines

Cutting direction is based on the fabric width and the way the fabric is cut from the roll and applied to Coalesse products. There are two cutting directions: railroaded or horizontal.

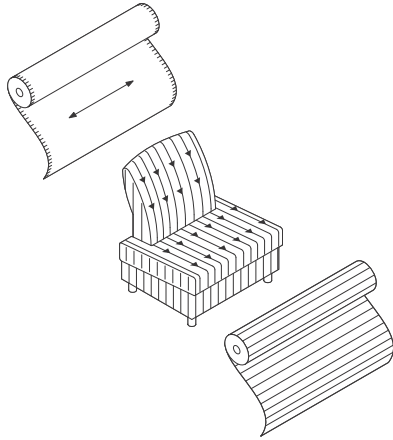

Horizontal or railroaded (across roll, warp horizontal) means fabric is cut across the roll; selvages are on the top and bottom.

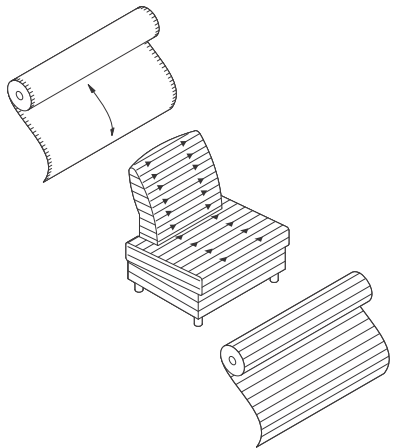

Vertical or top out (down roll, warp vertical) means fabric is cut in the same direction it is woven; selvages are on the left and right sides.

# Upholstery Matrix

Note: Coalesse reserves the right to reject fabrics when necessary if the quality or construction is not satisfactory for intended use. For most up to date information on fabric usage, please check the fabric database on [www.coalesse.com](http://www.coalesse.com).

	Chance Grade 12	Connoisseur 3 Grade 13	Conservation Grade 10	Divina Melange Grade 14/2CH	Frolic Grade 14	Hallingdal Grade 14/2CH	Link Grade 6	Pigment Grade 13	React Grade 10	Restore Grade 10	Rocket Grade 9	Salon Grade 9	Samba Grade 12	Sequence Grade 12	Souvenir Grade 10	Square Grade 12	Steady Grade 11	Steelcut Grade 13	Sustain Grade 10	Swayed All Over Grade COM	Tempera Grade 14	Whimsy Grade 11
Bindu	■	□	•	□	■	□	■	□	•	•	□	•	■	•	•	•	•	■	■	■	□	•
Bix	■	□	⊙	□	■	□	■	□	□	□	□	□	■	■	•	⊙	•	■	■	■	□	⊙
Chord	■	□	■	□	■	□	■	□	■	■	□	□	■	■	•	■	•	■	■	■	□	■
Circa	■	□	•	□	■	□	■	□	•	•	□	•	■	•	•	•	•	■	■	■	□	•
Coupe	■	□	■	□	■	□	■	□	■	■	□	□	■	■	■	■	•	■	■	■	□	■
Enea	■	□	■	□	■	□	■	□	■	■	□	□	■	■	■	■	•	■	■	■	□	■
Kathryn	■	□	■	□	■	□	■	□	■	■	□	□	■	■	■	■	•	■	■	■	□	■
Ripple	■	□	•	□	■	□	■	□	•	•	□	•	■	•	•	•	•	■	■	■	□	■

Disclaimer: Coalesse is pleased to provide this information. However, even after preliminary approval, Coalesse reserves the right to reject fabrics/leathers when necessary if the quality or construction is not satisfactory for the item it is intended for use on. Coalesse reserves the right to evaluate data daily and make any necessary changes or improvements to the information provided. Textile recommendations do not imply a warranty for the textiles. The textile manufacturer provides all warranties for textiles. All trademarks and trade names are the property of the different manufacturers. All pricing quotes for product should be obtained from your local Sales Representative or a Coalesse Customer Service Representative. Recommendations such as latex backing, Gore SP and CAL 133 will require additional cost and may require additional lead-time. All specifications are subject to change without notice.



# Upholstery Matrix

# Steelcase Upholstery Matrix

Note: Coalesse reserves the right to reject fabrics when necessary if the quality or construction is not satisfactory for intended use. For most up to date information on fabric usage please check the fabric database on [www.coalesse.com](http://www.coalesse.com).

**Legend**

- = Not available
- = Available
- ▶ See specification pages in the *Coalesse Specification Guides* for details.

	Steelcase Fabrics										
	Cogent: Connect Grade 06	Jacks Grade 06	Nitelights Grade 06	Link Grade 06	Dovetail by DesignTex Grade 07	SoftNext Grade 07	Stand In Grade 07	New Black Grade 07	Billiard Multi-Use by DesignTex Grade 08	Remix Grade 09	Bo Peep Grade 10
Await	•	■	■	■	■	■	■	■	■	■	■
Bindu	■	■	■	■	■	■	■	■	■	■	■
Bix Cushions	■	■	■	■	■	■	■	■	■	■	■
Bix Screen	■	■	•	■	■	■	■	■	■	■	■
Bob	■	■	■	■	■	■	■	■	■	■	■
Capa	■	■	■	■	■	■	■	■	■	■	■
Chord	■	■	■	■	■	■	■	■	■	■	■
Circa	•	■	■	■	■	■	■	■	■	■	■
Coupe	■	■	■	■	■	■	■	■	■	■	■
Davos	■	■	■	■	■	■	■	■	■	■	■
Elbow Chair CH20	•	•	•	•	•	•	•	•	•	•	•
EMU Outdoor Cushion	•	•	•	•	•	•	•	•	•	•	•
EMU Indoor Cushion	■	■	■	■	■	■	■	■	■	■	■
Enea	■	■	■	■	■	■	■	■	■	■	■
Enea Lottus	■	■	■	■	■	■	■	■	■	■	■
Exponents, Benches	■	■	■	■	■	■	■	■	■	■	■
Hosu	■	■	■	■	■	■	■	■	■	■	■
Joel	■	■	■	■	■	■	■	■	■	■	■
Kathryn	■	■	■	■	■	■	■	■	■	■	■
Lounge Seating CH100 Series	•	•	•	•	•	•	•	•	•	•	•
Millbrae Contract	■	■	■	■	■	■	■	■	■	■	■
Millbrae Lifestyle	•	■	■	■	■	■	■	■	■	■	■

▶ Continued on next page

The above Steelcase fabrics are available as standard without a backer on select Coalesse product lines. For those product lines that are noted as unavailable, it may be specifiable with a backer as a Select Surface fabric. Additional Steelcase fabrics are available through the Select Surfaces program. Please consult the Coalesse Fabric Database for availability.

Disclaimer: Coalesse is pleased to provide this information. However, even after preliminary approval, Coalesse reserves the right to reject fabrics/leathers when necessary if the quality or construction is not satisfactory for the item it is intended for use on. Coalesse reserves the right to evaluate data daily and make any necessary changes or improvements to the information provided. Textile recommendations do not imply a warranty for the textiles. The textile manufacturer provides all warranties for textiles. All trademarks and trade names are the property of the different manufacturers. All pricing quotes for product should be obtained from your local Sales Representative or a Coalesse Customer Service Representative. Recommendations such as backing and CAL 133 will require additional cost and may require additional lead-time. All specifications are subject to change without notice.

# Steelcase Upholstery Matrix

Note: Coalesse reserves the right to reject fabrics when necessary if the quality or construction is not satisfactory for intended use. For most up to date information on fabric usage please check the fabric database on [www.coalesse.com](http://www.coalesse.com).

▶ Continued, from previous page

**Legend**

- = Not available
- = Available
- ▶ See specification pages in the *Coalesse Specification Guides* for details.

	Steelcase Fabrics										
	Cogent: Connect Grade 06	Jacks Grade 06	Nitelights Grade 06	Link Grade 06	Dovetail by Designtex Grade 07	SoftNext Grade 07	Stand In Grade 07	New Black Grade 07	Billiard Multi-Use by Designtex Grade 08	Remix Grade 09	Bo Peep Grade 10
Lagunitas Cushion	■	■	■	■	■	■	■	■	■	■	■
Lox	•	■	■	■	•	•	■	■	•	•	■
Montara650	■	■	■	■	■	■	■	■	■	■	■
Passerelle	■	■	■	■	■	■	■	■	■	■	■
Ripple	•	■	■	■	■	■	■	■	■	■	■
Sidewalk	■	■	■	■	■	■	■	■	■	■	■
SW_1	■	■	■	■	■	■	•	■	■	■	■
Switch	■	■	■	■	■	■	■	■	■	■	■
Together	■	■	■	■	■	■	■	■	■	■	■
Visalia	■	■	■	■	■	■	■	■	■	■	■
Wrapp	•	■	■	■	■	■	■	■	■	■	■

The above Steelcase fabrics are available as standard without a backer on select Coalesse product lines. For those product lines that are noted as unavailable, it may be specifiable with a backer as a Select Surface fabric. Additional Steelcase fabrics are available through the Select Surfaces program. Please consult the Coalesse Fabric Database for availability.

Disclaimer: Coalesse is pleased to provide this information. However, even after preliminary approval, Coalesse reserves the right to reject fabrics/leathers when necessary if the quality or construction is not satisfactory for the item it is intended for use on. Coalesse reserves the right to evaluate data daily and make any necessary changes or improvements to the information provided. Textile recommendations do not imply a warranty for the textiles. The textile manufacturer provides all warranties for textiles. All trademarks and trade names are the property of the different manufacturers. All pricing quotes for product should be obtained from your local Sales Representative or a Coalesse Customer Service Representative. Recommendations such as backing and CAL 133 will require additional cost and may require additional lead-time. All specifications are subject to change without notice.

# Surface Materials - Leather/Faux

## Leather

### ELMOSOFT, ELMORUSTICAL LEATHER CARE

Only the finest hides are used for Elmo leather. Expect some color variations from hide to hide due to the aniline state of the product. Color fading may occur if leather is exposed to direct or intense light. Care is required to allow this product to achieve the rich natural patina that beautiful natural leather develops. The hallmarks of this leather include some naturally occurring markings, such as healed scars, insect bites, stretch marks, and fat wrinkles. Elmorustical's leather treatment is very natural with little protection from spills or body oils. This rich leather will exhibit stains and oils through normal use. Coalesse is not responsible for discoloration, spotting, or staining on this leather.

### Special Color Match Leather

Coalesse can provide a special color match in its leather to any supplier's leather color, paint color, carpet color, wallpaper color, etc. Sample to match must be submitted to Coalesse with purchase order. Sample for approval can be supplied if requested.

*Note: Minimum order 2,500 sq. ft.*

### Special Fabric Applications

#### Backing

- Backing information is found on each product page. Select this option when ordering your product to have backing applied. Price varies by product according to yardage it requires.

*Tip: Prices subject to change without notice and an additional 2 week lead time will apply for 54" wide fabrics. Wider fabrics will require 4 week additional lead time.*

## Café Leather

### Grade C

#### Café Leather

L208	Black Tea
L209	Earl Grey
L210	Espresso Bean
L211	Mousse
L212	Candied Pecan
L213	Chai
L214	Blueberry Tart

## Elmo Leather

Coalesse uses leathers that are provided by Elmo of Sweden. Elmosoft is a full grain, aniline dyed, semi-aniline finish. With Elmosoft leather, now recyclable and chromium-free, you have the opportunity to bid on green projects when requested. Elmosoft leathers are never corrected, buffed, or altered in any way. Coalesse purchases only original full grain leathers. The quality of this genuine leather can be felt in the hand immediately. Other leathers are often stiff because of the amount of pigment needed to cover the imperfections of an inferior hide. Using leather of a low quality affects the overall quality of the furniture it is upholstered on. You can feel confident in leather purchased from Coalesse.

## Elmosoft

### Grade C

#### Elmosoft

L110	Maritime Blue
L111	Midnight Blue
L112	Ebony
L113	Gunmetal
L114	Mica
L115	Dove Grey
L116	Plum Pleasure
L122	Truffle
L128	Red Birch
L133	Espresso
L134	Ruby
L139	Cinder
L140	Garnet
L143	Pecan
L144	Chamois
L146	Russet
L147	Saddle
L151	White
L709	Sugar
L711	Parchment
L717	Cameo
L723	Storm
L725	Teal
L727	Egyptian Blue
L728	Bright Blue
L730	Hunter
L743	Forest Green
L747	Cigar
L749	Beaver
L750	Bluffstone
L755	Peanut Butter
L758	Mustard
L762	Canvas
L763	Macadamia
L770	Cadet
L772	Timberwolf
L773	Chalice
L774	Oil
L775	Coyote

## Elmorustical Leather and Elmotique

Elmorustical and Elmotique is a full top grain, aniline dyed leather.

Elmorustical has a grain which varies in structure and offers outstanding comfort. It is an aniline leather with all the distinct features of the natural hide.

Elmotique is a thinner aniline leather with a batique-effect and displays all the features possessed by the original hide.

Only the finest hides are used for Elmorustical and Elmotique leathers. Expect some color variations from hide to hide due to the aniline state of the product. Color fading may occur if leather is exposed to direct or intense light. Care is required to allow this product to achieve the rich natural patina that beautiful leather develops. The hallmarks of this leather include some naturally occurring markings such as healed scars, insect bites, stretch marks, and fat wrinkles. Elmorustical and Elmotique's leather treatment is very natural with little protection from spills or body oils. This rich leather will exhibit stains and oils through normal use. Coalesse is not responsible for discoloration, spotting, or staining on this leather.

### Grade E

#### Elmorustical

L318	Loam
L319	Ebony
L321	Beige
L323	Buff
L325	Camel
L326	Charbrown
L330	Flame
L332	Honey
L334	Mist Green
L337	Russet
L338	Rust
L363	Tendrill
L364	Fog
L365	Sunflower
L366	Terra Cotta
L367	Cadet
L368	Marine
L369	Mallard
L370	Smoke
L371	Merlot
LD54	Twilight

#### Elmotique

L310	Sage Brush
L311	Flaxen
L312	Earth
L313	Clay
L314	Blue Mountain
L315	Juniper

## Faux Leather

Coalesse offers a variety of faux leathers. Not all faux leathers are available on all products, check seating matrix to determine availability. **►Page 207**

### Grade 10

Brisa  
*(For a visual palette, please refer to the Steelcase Finish Library)*

BR01	Black Onyx
BR04	Truffle
BR06	Ash
BR07	Sage
BR08	Celery
BR09	Sterling Blue
BR10	Night Navy
BR11	Cambridge Blue
BR12	Abbyss
BR14	Pompeia
BR16	Cinnabar
BR18	New Sand
BR20	White
BR21	Moccasin
BR22	Buckskin
BR24	Mineral
BR25	Skyway
BR26	Iron
BR27	Stormy
BR28	Esmeralda
BR29	Seaweed
BR30	Bone
BR31	Caramel
BR32	Bridle
BR33	Moon

# Surface Materials - Leather/Faux

<p><b>Grade 11</b></p> <p><b>Destiny</b></p> <p>DY01 Black</p> <p>DY02 Raisin</p> <p>DY03 Blueberry</p> <p>DY04 Chestnut</p> <p>DY05 Cedar</p> <p>DY06 Black Rose</p> <p>DY07 Wine</p> <p>DY09 Dune</p> <p>DY10 Truffle</p> <p>DY11 Oak</p> <p>DY12 Newport</p> <p>DY13 Evergreen</p> <p>DY14 Storm</p> <p>DY15 Juniper</p> <p>DY16 Olive</p> <p>DY17 Mocha</p> <p>DY18 Ash</p> <p>DY21 Butter</p> <p>DY23 Deep Red</p> <p>DY24 Eggshell</p> <p>DY26 Parchment</p> <p>DY27 Periwinkle</p> <p>DY30 Royal Purple</p> <p>DY31 Saddle</p> <p>DY32 Cactus Green</p> <p>DY33 Cypress</p> <p>DY34 Mink</p> <p>DY35 Football</p> <p>DY36 Root</p> <p><b>Finesse</b></p> <p>AM00 White Cloud</p> <p>AM01 Gelato</p> <p>AM02 Winter White</p> <p>AM04 Mushroom</p> <p>AM06 Charbrown</p> <p>AM08 Iceberg</p> <p>AM09 Gravel</p> <p>AM10 Colonial Blue</p> <p>AM24 Rye</p> <p>AM25 Barley</p> <p>AM26 Stucco</p> <p>AM27 Beaver</p> <p>AM28 Otter</p> <p>AM65 Bordeaux</p> <p>AM66 Navy</p> <p>AM67 Cinder</p> <p>AM80 Cameo</p> <p>AM81 Oyster Grey</p> <p>AM83 Taupe</p> <p>AM85 Chestnut</p> <p>AM87 Indigo</p> <p>AM88 Bone</p> <p>AM89 Jet Black</p> <p>AM92 Burgundy</p> <p>AM93 Hunter Green</p> <p>AM98 Oxford Brown</p> <p><b>Ovation</b></p> <p>O500 Dark Brown</p> <p>O501 Light Grey</p> <p>O502 Sage</p> <p>O503 Indigo</p> <p>O504 Lilac</p> <p>O505 Terra</p> <p>O506 Moss</p> <p>O507 Teal</p> <p>O508 Stone</p> <p>O509 Cappuccino</p>	<p><b>Panache</b></p> <p>P800 Ebony</p> <p>P801 Cactus</p> <p>P802 Sherwood</p> <p>P803 Teal Blue</p> <p>P804 Sweet Sage</p> <p>P805 Coffee</p> <p>P806 True Taupe</p> <p>P807 Cashew</p> <p>P808 Acorn</p> <p>P809 Redwood</p> <p>P810 Exotic Orchid</p> <p>P811 Maize</p> <p>P812 Chartreuse</p> <p>P813 Regal Blue</p> <p><b>Prestige</b></p> <p>AFA1 Onyx</p> <p>AFB2 Soft White</p> <p>AFC3 Saxe Blue</p> <p>AFD3 Buff</p> <p>AFDG Antique White</p> <p>AFE1 Sandstone</p> <p>AFH1 Pecan</p> <p>AFH2 Buttercreme</p> <p>AFI1 Havana</p> <p>AFI2 Brick</p> <p>AFK1 Parchment</p> <p>AFL8 French Grey</p> <p>AFP1 Willow</p> <p>AFP2 Boxwood Green</p> <p>AFPA Tree Moss</p> <p>AFPC Celadon</p> <p>AFS3 Wild Plum</p>	<p><b>Grade 12</b></p> <p><b>Elegance</b></p> <p>EL01 Ivory</p> <p>EL02 Cream</p> <p>EL03 Char</p> <p>EL04 Saddle</p> <p>EL05 Dune</p> <p>EL06 Camel</p> <p>EL07 Sage</p> <p>EL08 Gray</p> <p>EL09 Walnut</p> <p>EL10 Burgundy</p> <p>EL11 Green</p> <p>EL12 Navy</p> <p>EL13 Black</p>	<p><b>Grade 13</b></p> <p><b>Destiny Perforated</b></p> <p>DP01 Black</p> <p>DP02 Raisin</p> <p>DP03 Blueberry</p> <p>DP04 Chestnut</p> <p>DP05 Cedar</p> <p>DP06 Black Rose</p> <p>DP07 Wine</p> <p>DP09 Dune</p> <p>DP10 Truffle</p> <p>DP11 Oak</p> <p>DP12 Newport</p> <p>DP13 Evergreen</p> <p>DP14 Storm</p> <p>DP15 Juniper</p> <p>DP16 Olive</p> <p>DP17 Mocha</p> <p>DP21 Butter</p> <p>DP23 Deep Red</p> <p>DP24 Eggshell</p> <p>DP26 Parchment</p> <p>DP27 Periwinkle</p> <p>DP30 Royal Purple</p> <p>DP31 Saddle</p> <p>DP32 Cactus Green</p> <p>DP33 Cypress</p> <p>DP34 Mink</p> <p>DP35 Football</p> <p>DP36 Root</p> <p><b>Finesse Perforated</b></p> <p>AP00 White Cloud</p> <p>AP01 Gelato</p> <p>AP02 Winter White</p> <p>AP04 Mushroom</p> <p>AP06 Charbrown</p> <p>AP08 Iceberg</p> <p>AP09 Gravel</p> <p>AP10 Colonial Blue</p> <p>AP24 Rye</p> <p>AP25 Barley</p> <p>AP26 Stucco</p> <p>AP27 Beaver</p> <p>AP28 Otter</p> <p>AP65 Bordeaux</p> <p>AP66 Navy</p> <p>AP67 Cinder</p> <p>AP80 Cameo</p> <p>AP81 Oyster Grey</p> <p>AP83 Taupe</p> <p>AP85 Chestnut</p> <p>AP87 Indigo</p> <p>AP88 Bone</p> <p>AP89 Jet Black</p> <p>AP92 Burgundy</p> <p>AP93 Hunter Green</p> <p>AP98 Oxford Brown</p>	<p><b>Panache Perforated</b></p> <p>PR00 Ebony</p> <p>PR01 Cactus</p> <p>PR02 Sherwood</p> <p>PR03 Teal Blue</p> <p>PR04 Sweet Sage</p> <p>PR05 Coffee</p> <p>PR06 True Taupe</p> <p>PR07 Cashew</p> <p>PR08 Acorn</p> <p>PR09 Redwood</p> <p>PR10 Exotic Orchid</p> <p>PR11 Maize</p> <p>PR12 Chartreuse</p> <p>PR13 Regal Blue</p> <p><b>Prestige Perforated</b></p> <p>APA1 Onyx</p> <p>APB2 Soft White</p> <p>APC3 Saxe Blue</p> <p>APD3 Buff</p> <p>APDG Antique White</p> <p>APE1 Sandstone</p> <p>APH1 Pecan</p> <p>APH2 Buttercream</p> <p>API1 Havana</p> <p>API2 Brick</p> <p>APK1 Parchment</p> <p>APL8 French Grey</p> <p>APP1 Willow</p> <p>APP2 Boxwood Green</p> <p>APPA Tree Moss</p> <p>APPC Celadon</p> <p>APSP3 Wild Plum</p>
--	---	---	---	--

# Cut Yardage Net Price List

FABRIC NAME	Under 60 Yards	60 Yards & Over
<b>Elegance®</b>	\$112.00/yd.	\$104.00/yd.
<b>Finesse®</b>	\$ 68.00/yd.	\$ 67.00/yd.
<b>Finesse® Perforated</b> (min. 5 yds)	\$ 81.00/yd.	\$ 80.00/yd.
<b>Prestige®</b>	\$ 73.00/yd.	\$ 70.00/yd.
<b>Prestige® Perforated</b> (min. 5 yds)	\$ 88.00/yd.	\$ 84.00/yd.
<b>Destiny®</b>	\$ 74.00/yd.	\$ 72.00/yd.
<b>Destiny® Perforated</b> (min. 5 yds)	\$ 89.00/yd.	\$ 85.00/yd.
<b>Ovation</b>	\$ 74.00/yd.	\$ 70.00/yd.
<b>Panache</b>	\$ 74.00/yd.	\$ 72.00/yd.

LEATHER NAME	Under 500 sq. ft.	500-1000 sq. ft.	Over 1000 sq.ft.
<b>Elmosoft</b>	\$9.00/sq. ft.	\$8.00/sq. ft.	\$7.50/sq. ft.
<b>Elmorustical*</b>	\$15.00/sq. ft.	\$9.00/sq. ft.	\$8.50/sq. ft.

### ORDERING INFORMATION

- Minimum Order Requirements
  - Fabric: 1 yd. - 1/8 yd. increments.
  - Leather: 1 full hide (avg. sq. ft./hide - 50).
  - All orders will be filled in full hides only.
  - Overage will be invoiced accordingly.
- Special match leather: 2,500 sq. ft. minimum (Check delivery date)
- The embossing techniques used on Novasuede Perforated to achieve these looks involve very high temperatures. Color and shade may vary slightly based on the fiber density being embossed.
- Cancelled textile orders are subject to a 30% restocking fee. Order must be cancelled 5 days before ship date.
- Due to the natural processes of dyeing, sanding and embossing necessary to achieve these special looks, actual production may vary slightly in appearance from the swatches shown.

### COALESSE TEXTILE WARRANTY

Coalesse textile merchandise is produced in accordance with Coalesse high standards. Coalesse does not guarantee, warrant or accept any responsibility whatsoever by reason of its fabrics or leathers fading, wearing, cracking, shrinking, stretching, tearing, seam slippage, alteration in color due to any finish treatment (flameproofing, stain repellent, etc.) or discoloration from liquid contact. Printed textiles are not warranted against irregularity in register. Coalesse is not responsible for dye lot differences or discrepancies in widths of fabrics. Coalesse does not guarantee, warrant or represent an exact color match to cuttings, tabs, memos or sample cards. Coalesse does not warrant exact matching of color or grain of leather. Leather hides may contain certain natural marks, scars, scratches, wrinkles and shade variations within hides, etc., considered by leather tanneries and Coalesse to be inherent characteristics part of the natural beauty of leather and the size or location of such markings cannot be controlled. In any event, upon inspection, Coalesse's responsibility shall be limited to either replacement of merchandise or refund of purchase price at Coalesse's option. The foregoing constitutes the sole and exclusive remedy of the customer. Coalesse is not responsible for the application or installation of our products. In no event shall Coalesse be responsible for any consequential damages or any charges, costs, expenses, or obligations other than as expressly herein set forth. Coalesse makes no other warranties, expressed or implied, as to any product sold by Coalesse. All other warranties (including any warranty of merchantability or fitness for any particular purpose) are hereby excluded.

# Leather and Faux Leather Matrix

Note: Coalesse reserves the right to reject fabrics when necessary if the quality or construction is not satisfactory for intended use. For most up to date information on fabric usage, please check the fabric database on [www.coalesse.com](http://www.coalesse.com).

**Legend**

- = Not available
- = Available
- ☐ = Must be ordered as COM or COL
- ▣ = Available but will puddle
- ▶ See specification pages for details.

	Café Leather Grade C	Elmosoft Grade C	Elmotique Grade E	Elmorustical Grade E	Loke Leather	Brisa Grade 10	Destiny Grade 11	Destiny Perforated Grade 13	Prestige Grade 11	Prestige Perforated Grade 13	Finesse Grade 11	Finesse Perforated Grade 13	Elegance Grade 12	Panache Grade 11	Panache Perforated Grade 13	Ovation Grade 11
Await	■	■	•	■	☐	■	■	■	■	■	■	■	■	■	■	■
Bindu	■	■	•	■	☐	■	■	■	■	■	■	■	■	■	■	■
Bix	■	■	•	■	•	■	■	•	■	•	■	•	■	■	•	■
Bob	■	■	•	■	•	■	■	•	■	•	■	•	■	■	■	■
Capa	■	■	•	■	☐	■	■	■	■	■	■	■	■	■	■	■
Chord	■	■	•	■	☐	■	■	■	■	■	■	■	■	■	■	■
Circa	■	■	•	■	☐	■	■	■	■	■	■	■	■	■	■	■
Coupe	■	■	•	■	☐	■	■	■	■	■	■	■	■	■	■	■
Davos	■	■	•	■	•	■	■	•	■	•	■	•	■	■	•	■
EMU Indoor Cushion	■	■	■	■	•	■	■	■	■	■	■	■	■	■	•	■
Enea	■	■	•	■	☐	■	■	■	■	■	■	■	■	■	■	■
Enea Lottus	■	■	■	■	•	■	■	•	■	•	■	•	■	■	•	■
Exponents (Benches)	■	■	•	■	•	■	■	■	■	■	■	■	■	■	•	■
Joel	■	■	•	■	•	■	■	•	■	•	■	•	■	■	•	■
Kathryn	■	■	■	■	☐	■	■	■	■	■	■	■	■	■	■	■
Lagunitas	■	■	•	■	•	■	■	■	■	■	■	■	■	■	■	■
Lox	■	■	■	■	•	■	■	•	■	•	■	•	■	■	•	■
Millbrae Contract	■	■	•	■	☐	■	■	■	■	■	■	■	■	■	■	■
Millbrae Lifestyle	■	■	■	■	☐	■	■	■	■	■	■	■	■	■	■	■
Montara650	■	■	•	■	•	■	■	•	■	•	■	•	■	■	■	■
Passerelle	■	■	•	■	☐	■	■	■	■	■	■	■	■	■	■	■
Ripple	■	■	•	■	☐	■	■	■	■	■	■	■	■	■	■	■
SW_1	■	■	•	■	•	■	■	•	■	•	■	•	■	■	•	■
Switch	■	■	•	■	☐	■	■	■	■	■	■	■	■	■	■	■
Together	▣	▣	•	▣	•	▣	▣	•	▣	•	▣	•	▣	▣	•	■
Visalia	■	■	•	■	☐	■	■	■	■	■	■	■	■	■	■	■
Wrapp	■	■	•	■	•	■	■	■	■	■	■	■	■	■	■	■

Disclaimer: Coalesse is pleased to provide this information. However, even after preliminary approval, Coalesse reserves the right to reject fabrics/leathers when necessary if the quality or construction is not satisfactory for the item it is intended for use on. Coalesse reserves the right to evaluate data daily and make any necessary changes or improvements to the information provided. Textile recommendations do not imply a warranty for the textiles. The textile manufacturer provides all warranties for textiles. All trademarks and trade names are the property of the different manufacturers. All pricing quotes for product should be obtained from your local Sales Representative or a Coalesse Customer Service Representative. Recommendations such as latex backing, Gore SP and CAL 133 will require additional cost and may require additional lead-time. All specifications are subject to change without notice.

# Surface Materials - Wood

## Wood

### Standard Wood Finishes

Coalesse's primary wood finish, Clarity, is a water-borne UV topcoat, which protects the environment while providing exceptional durability and resistance to water and chemical stains. Contoured products, such as wood guest chairs and occasional tables, are finished with post-catalyzed vinyl, which provides similar properties and matches the sheen and color of Clarity. Due to natural variations in wood, finished products may vary from samples in color, texture, and grain.

**Wood** will develop a deep, rich patina over time as the wood ages. Mineral streaks, gum pockets, and pin knots are some of the unique characteristics that are visible in veneers and solids.

**All wood products** will darken with age and exposure to ultraviolet light. This is especially apparent with cherry and maple veneer.

When storing your wood furniture, please follow the following guidelines:

- Do not store products in trailers
- Store products in areas that simulate office temperatures (60°F to 90°F)
- Store products in areas that maintain constant, office-like humidity levels
- Keep product away from light. Cover products to make sure they are not exposed to light.

**Samples** contact Customer Service at 1.800.627.6770

### Steelcase Wood Finishes

**Coalesse** will match current Steelcase wood finishes at no upcharge. Finish matches are for color only and do not match the Steelcase finish in sheen.

**Natural veneers** celebrate the natural beauty of wood with neutral tones.

**Plank veneers** were intentionally designed to enhance the unique characteristics of wood with natural variations that include grain pattern, color, and texture that are meant to be celebrated.

### Stain-To-Match Wood Finish

**Coalesse** will stain-to-match any wood finish with a one-time \$500 net charge per customer per finish. Customers must work with Concierge team to advise species, cut, and sheen and submit a sample with a surface dimension of at least 3" x 3" for matching. Coalesse requires written approval of a strike-off sample before starting production. When ordering, customers must select the applicable finish code, specifying cut and species, and reference the Customiz stain finish number attached to the match. The one-time charge and strike-off sample is not required for standard Steelcase or Coalesse finishes. Contact Concierge team for additional program details.

Phone: 1.866.645.6952

Email: concierge@steelcase.com

### Steelcase Select Surfaces

In addition to the standard Steelcase veneer palette, Coalesse offers Steelcase Select Surfaces.

**Composite veneers** are engineered veneer intended to create consistent grain patterns and characteristics with minimal inconsistency within an order. Please note that because these finishes are part of Steelcase Select Surfaces, they may have additional lead times.

### Painted MDF

The **Painted medium density fiberboard (MDF)** is utilizing molding grade MDF, therefore, the 45 lb density is consistent throughout the entire thickness of the board. This allows for a smooth edge when painted. Three coats of water reducible finish is applied to the board in a milk or black. The painted MDF has durability and care properties like a wood veneer, thus, must be treated as such.

### Wood Veneer Specifications

#### Cherry

- American Black Cherry
- Flat-cut, plain sliced/book matched
- Quarter-cut/book matched
- Narrow cathedrals, mild grain, minimal pitch
- 5-10" wide leaves of 1/42" thick veneer, balanced on panel
- No gaps between leaves
- PB (particle board) core
- Low sheen 15 or high sheen 35

#### Maple

- Eastern Hard White Maple
- Flat-cut, plain sliced/slip matched
- Quarter-cut/book matched
- Narrow cathedrals, mild grain, minimal pitch
- 5-10" wide leaves of 1/42" thick veneer, balanced on panel
- No gaps between leaves
- PB (particle board) core
- Low sheen 15 or high sheen 35

#### Oak

- White Oak
- Rift-cut
- Slip match
- Mild grain
- 4-8" wide leaves of 1/42" thick veneer, balanced on panel
- No gaps between leaves
- PB (particle board) core
- Low sheen 15 or high sheen 35

#### Walnut

- American Black Walnut
- Flat-cut, plain sliced/book matched
- Quarter-cut/book matched
- Narrow cathedrals, mild grain
- 5-10" wide leaves of 1/42" thick veneer, balanced on panel
- No gaps between leaves
- PB (particle board) core
- Low sheen 15 or high sheen 35

Exclusive (by product)

#### Teak

- Quarter-cut/book match
- 15 sheen

#### Ash (Grey)

- Quarter-cut/book match
- 15 sheen

### Flat-Cut – High Sheen

#### Grade 1

- V10C FC/HS Natural Cherry
- V11C FC/HS Clear Cherry
- V12C FC/HS Medium Amber Cherry
- V13C FC/HS Dark Cherry
- V10M FC/HS Clear Maple
- V11M FC/HS Natural Beech on Maple
- V12M FC/HS Medium Maple
- V10W FC/HS Natural Walnut
- V11W FC/HS Clear Walnut
- V12W FC/HS Medium Walnut
- V13W FC/HS Black Walnut
- V14W FC/HS Dark Walnut

### Flat-Cut – Low Sheen

#### Grade 1

- V1AC FC/LS Natural Cherry
- V1BC FC/LS Clear Cherry
- V1CC FC/LS Medium Amber Cherry
- V1DC FC/LS Dark Cherry
- V1AM FC/LS Clear Maple
- V1BM FC/LS Natural Beech on Maple
- V1CM FC/LS Medium Maple
- V1AW FC/LS Natural Walnut
- V1BW FC/LS Clear Walnut
- V1CW FC/LS Medium Walnut
- V1EW FC/LS Dark Walnut

### Rift-Cut – High Sheen

#### Grade 1

- V30K RC/HS Natural Oak
- V31K RC/HS Desert Oak
- V32K RC/HS Medium Brown Oak
- V33K RC/HS Medium Gray Oak
- V34K RC/HS Black Brown Oak

### Rift-Cut – Low Sheen

#### Grade 1

- V3AK RC/LS Natural Oak
- V3BK RC/LS Desert Oak
- V3CK RC/LS Medium Brown Oak
- V3DK RC/LS Medium Gray Oak
- V3EK RC/LS Black Brown Oak

FC=Flat Cut  
 RC=Rift Cut  
 QC=Quarter Cut  
 HS=High Sheen  
 LS=Low Sheen



# Surface Materials - Wood

## Quarter-Cut – High Sheen

### Grade 2

- V20C QC/HS Natural Cherry
- V21C QC/HS Clear Cherry
- V22C QC/HS Medium Amber Cherry
- V23C QC/HS Dark Cherry
- V20M QC/HS Clear Maple
- V21M QC/HS Natural Beech on Maple
- V22M QC/HS Medium Maple
- V20W QC/HS Natural Walnut
- V21W QC/HS Clear Walnut
- V22W QC/HS Medium Walnut
- V23W QC/HS Black Walnut
- V24W QC/HS Dark Walnut

## Quarter-Cut – Low Sheen

### Grade 2

- V2AA QC/LS Ash Natural FSC
- V2AC QC/LS Natural Cherry
- V2BC QC/LS Clear Cherry
- V2CC QC/LS Medium Amber Cherry
- V2DC QC/LS Dark Cherry
- V2AM QC/LS Clear Maple
- V2BM QC/LS Natural Beech on Maple
- V2CM QC/LS Medium Maple
- V2AW QC/LS Natural Walnut
- V2BW QC/LS Clear Walnut
- V2CW QC/LS Medium Walnut
- V2EW QC/LS Dark Walnut
- V2AT QC/LS Teak Natural Raw FSC

## Steelcase Veneers, Open Pore Only

### Grade 1

#### Cherry, Flat-Cut

- 3402 FC/OP Clear Cherry
- 3412 FC/OP Natural Cherry
- 3422 FC/OP Medium Cherry

#### Maple, Flat-Cut

- 3522 FC/OP Clear Maple
- 3592 FC/OP Blonde on Maple

#### Maple, Quarter-Cut

- 3222 QC/OP Clear Maple
- 3292 QC/OP Blonde on Maple

#### Walnut, Flat-Cut

- 3062 FC/OP Graphite Walnut
- 3342 FC/OP Black Walnut
- 3702 FC/OP Clear Walnut
- 3712 FC/OP Natural Walnut
- 3752 FC/OP Medium Walnut
- 3762 FC/OP Dark Walnut
- 3772 FC/OP Medium Mahogany on Walnut

#### Walnut, Quarter-Cut

- 3302 QC/OP Clear Walnut
- 3312 QC/OP Natural Walnut
- 3352 QC/OP Medium Walnut
- 3362 QC/OP Dark Walnut
- 3372 QC/OP Medium Mahogany on Walnut
- 3382 QC/OP Graphite Walnut
- 3392 QC/OP Black Walnut

#### Oak, Rift-Cut

- 3602 RC/OP Desert Oak
- 3612 RC/OP Warm Oak

#### Premium Wood, Quarter-Cut

- 3832 QC/OP Figured Anegre

#### Planked Veneer

- 3P41 OP Planked Cherry
- 3P51 OP Planked Maple
- 3P61 OP Planked Oak
- 3P71 OP Planked Walnut
- 3VFX OP Unmarked Oak

#### Natural Veneer, Flat-Cut

- 35A2 FC/OP Blanch Maple
- 37A2 FC/OP Thunder Walnut

#### Natural Veneer, Rift Cut

- 36A2 RC/OP Volcanic Oak

### Grade 2

#### Ash, Quarter-Cut

- 3042 QC/OP Ash

#### Natural Veneer, Flat-Cut

- 3082 FC/OP Washed Walnut

#### Natural Veneer, Quarter Cut

- 32A2 QC/OP Blanch Maple
- 33A2 QC/OP Thunder Walnut

## Composite Veneer Group 1

### Composite Flat-Cut Open-Pore

- 3JDX FC/OP Oak Composite
- 3JJX FC/OP Walnut Composite
- 3LAX FC/OP Graphite on Oak Composite
- 3LCX FC/OP Medium Cherry on Cherry Composite

### Composite Quarter-Cut Open-Pore

- 3F8X QC/OP European Walnut Composite
- 3GGX QC/OP Zebrano Composite
- 3HGX QC/OP Oak Composite
- 3HVX QC/OP Walnut Composite
- 3LBX QC/OP Clear Walnut on Walnut Composite
- 3LDX QC/OP Natural Walnut on Walnut Composite
- 3ZNX QC/OP Night Cerused Oak Composite

## Composite Veneer Group 2

### Composite Flat-Cut Open-Pore

- 3LHX FC/OP Espresso on Walnut Composite

### Composite Quarter-Cut Open-Pore

- 3LEX QC/OP Desert Oak on Oak Composite
- 3LGX QC/OP Chai on Walnut Composite
- 3LJX QC/OP Ebony on Walnut Composite

## Painted MDF

### Applies to: Exponents

- V145 Milk
- V197 Black

FC=Flat Cut  
 RC=Rift Cut  
 QC=Quarter Cut  
 HS=High Sheen  
 LS=Low Sheen  
 OP=Open Pore

# Solid Wood Matrix

For Solid Hardwood Components of Seating and Tables

**Legend**

- = Not available
- = Available
- = Stain color only on maple
- = Stain color on Beech
- ▶ See specification pages in the Coalesse Specification Guides for details.

	Maple Flat-Cut – High Sheen	Maple Flat-Cut – Low Sheen	Maple Quarter-Cut – High Sheen	Maple Quarter-Cut – Low Sheen	Cherry Flat-Cut – High Sheen	Cherry Flat-Cut – Low Sheen	Cherry Quarter-Cut – High Sheen	Cherry Quarter-Cut – Low Sheen	Oak Rift-Cut – High Sheen	Oak Rift-Cut – Low Sheen	Walnut Flat-Cut – High Sheen	Walnut Flat-Cut – Low Sheen	Walnut Quarter-Cut – High Sheen	Walnut Quarter-Cut – Low Sheen	Teak Quarter-Cut – High Sheen	Teak Quarter-Cut – Low Sheen	Grey Ash – High Sheen	Grey Ash – Low Sheen
<b>Seating</b>																		
Circa Cylinder Legs	•	•	•	•	•	•	•	•	■	■	•	•	•	•	•	•	•	•
Circa Tapered Legs	•	•	■	■	•	•	•	•	•	•	•	•	■	■	•	•	•	•
Coupe Lounge	■	■	•	•	■	■	•	•	■	■	■	■	•	•	•	•	•	•
Enea Altzo943	•	•	•	•	•	•	•	•	•	■	•	•	•	•	•	•	•	•
Enea Café Wood Stool*	•	•	•	•	•	•	•	•	•	■	•	•	•	•	•	•	•	•
Kathryn	■	■	•	•	■	■	•	•	■	■	■	■	•	•	•	•	•	•
Passerelle	■	■	•	•	■	■	•	•	■	■	■	■	•	•	•	•	•	•
Sistema Lounge System**	•	•	•	•	•	•	•	•	•	■	•	•	•	•	•	•	•	•

\* V3AK Natural Oak only.

\*\* Select colors only: VP01, VP02, VP03, VP04, and VP05

▶ Matrix, continued on next page

# Solid Wood Matrix

For Solid Hardwood Components of Seating and Tables

► Matrix, continued from previous page

Legend

- = Not available
- = Available
- = Stain color only on maple
- See specification pages in the Coalesse Specification Guides for details.

	Maple Flat-Cut – High Sheen	Maple Flat-Cut – Low Sheen	Maple Quarter-Cut – High Sheen	Maple Quarter-Cut – Low Sheen	Cherry Flat-Cut – High Sheen	Cherry Flat-Cut – Low Sheen	Cherry Quarter-Cut – High Sheen	Cherry Quarter-Cut – Low Sheen	Oak Rift-Cut – High Sheen	Oak Rift-Cut – Low Sheen	Walnut Flat-Cut – High Sheen	Walnut Flat-Cut – Low Sheen	Walnut Quarter-Cut – High Sheen	Walnut Quarter-Cut – Low Sheen	Teak Quarter-Cut – Low Sheen	Grey Ash – Low Sheen
<b>Occasional Tables</b>																
Circa Cylinder Legs	•	•	•	•	•	•	•	•	■	■	•	•	•	•	•	•
Circa Tapered Legs	•	•	■	■	•	•	•	•	■	■	•	•	■	■	•	•
Passerelle	■	■	•	•	■	■	•	•	■	■	■	■	•	•	•	•

# Veneer Matrix

For Conference and Café Tables, Storage, Casegoods, and Occasional Tables, and Seating

**Legend**

- = Not available
- = Available
- = Stain color only on maple
- = Stain color only
- ▶ See specification pages for details.

Maple Flat-Cut – High Sheen	Maple Flat-Cut – Low Sheen	Maple Quarter-Cut – High Sheen	Maple Quarter-Cut – Low Sheen	Cherry Flat-Cut – High Sheen	Cherry Flat-Cut – Low Sheen	Cherry Quarter-Cut – High Sheen	Cherry Quarter-Cut – Low Sheen	Oak Rift-Cut – High Sheen	Oak Rift-Cut – Low Sheen	Walnut Flat-Cut – High Sheen	Walnut Flat-Cut – Low Sheen	Walnut Quarter-Cut – High Sheen	Walnut Quarter-Cut – Low Sheen	Teak Quarter-Cut – Low Sheen	Grey Ash – Low Sheen	Wedge Cut Veneers – Any Species	Transolid – Solid Surface	Exclusive Finishes for Trees	Milk MDF	Black MDF	Composite Flat-Cut–Select Surfaces	Composite Quarter-Cut–Select Surfaces	Planked Veneers	Natural Veneers	Ash – Quarter-Cut	Premium Wood–Quarter-Cut
-----------------------------	----------------------------	--------------------------------	-------------------------------	------------------------------	-----------------------------	---------------------------------	--------------------------------	---------------------------	--------------------------	------------------------------	-----------------------------	---------------------------------	--------------------------------	------------------------------	----------------------	---------------------------------	---------------------------	------------------------------	----------	-----------	------------------------------------	---------------------------------------	-----------------	-----------------	-------------------	--------------------------

**Tables and Casegoods**

Bob	■	■	■	■	■	■	■	■	■	■	■	■	■	■	■	■	■	■	■	■	■	■	■	■	■
Circa	•	•	■	■	•	•	•	•	■	■	•	•	■	■	•	•	•	•	•	•	•	•	•	•	•
Diekman	■	■	•	•	■	■	•	•	■	■	■	■	■	•	•	•	•	•	•	•	•	•	•	•	•
E-Tables 2 Bases	■	■	■	■	■	■	■	■	■	■	■	■	■	•	•	•	•	•	•	•	•	■	■	■	■
E-Tables 2 Tops	■	■	■	■	■	■	■	■	■	■	■	■	■	•	•	•	•	•	•	•	•	■	■	■	■
Enea Lottus	■	■	■	■	■	■	■	■	■	■	■	■	■	•	•	•	•	•	•	•	•	■	■	■	■
Exponents	■	■	■	■	■	■	■	■	■	■	■	■	■	•	•	•	■	•	■	■	■	■	■	■	■
Host Bases	■	■	■	■	■	■	■	■	■	■	■	■	■	•	•	•	•	•	•	•	•	■	■	■	■
Host Tops	■	■	■	■	■	■	■	■	■	■	■	■	■	•	•	•	•	•	•	•	•	■	■	■	■
Lagunitas Focus Nook	■	■	■	■	■	■	■	■	■	■	■	■	■	•	•	•	•	•	•	•	■	■	■	■	■
Lagunitas Tables	■	■	■	■	■	■	■	■	■	■	■	■	■	•	•	•	•	•	•	•	■	■	■	■	■
Montara650	■	■	■	■	■	■	■	■	■	■	■	■	■	•	•	•	•	•	•	•	■	■	■	■	■
Sebastopol	■	■	■	■	■	■	■	■	■	■	■	■	■	•	•	•	•	•	•	•	■	■	■	■	■
Sidewalk	■	■	•	•	■	■	•	•	■	■	■	■	■	•	•	•	•	•	•	•	•	•	•	•	•
SW_1	■	■	■	■	■	■	■	■	■	■	■	■	■	•	•	■	■	•	•	■	■	■	■	■	■
Trees	•	•	•	•	•	•	•	•	•	•	•	•	•	•	•	•	■	•	•	•	•	•	•	•	•

**Seating**

Enea	■	■	•	•	■	■	•	•	■	■	■	■	•	•	•	•	•	•	•	•	•	•	•	•	•
Enea Café Wood Stool*	•	•	•	•	•	•	•	•	•	■	•	•	•	•	•	•	•	•	•	•	•	•	•	•	•
Montara650**	•	•	•	•	•	•	•	•	•	■	•	•	•	•	•	•	•	•	•	•	•	•	•	•	•

\* V3AK Natural Oak only

\*\* Select colors only: VP01, VP02, VP03, VP04, and VP05

# Surface Materials - Laminate

## Laminate

Coalesse's graded laminate program includes our standard laminates, Steelcase High-Pressure Laminates, and standard High-Pressure Laminates from Nevamar, Wilsonart, Formica, and Pionite.

### Standard Coalesse Laminate

#### Grade 1

Coalesse High-Pressure Laminates are priced as Grade 1.

High-Pressure Laminates listed below are not available on all products, check laminate matrix for availability.

- 2730 Arctic White
- 2746 Black
- 2759 Warm White
- 2826 White Nebula
- 2829 Poppyseed
- 2830 Charcoal
- 2884 Milk
- 2886 Maple
- 2887 Amber Cherry
- 2890 Folkstone BMW
- 2891 Ingot
- 2892 Ash
- 2894 Natural Cork
- 2895 Natural Walnut
- 2896 Dark Cork
- 2897 Desert Oak
- 2898 Satin Stainless

### Standard Steelcase Laminate

#### Grade 1

All Steelcase High-Pressure Laminates may be specified on Coalesse products with exception (must be ordered as Special): Await tables and Enea Lottus tables. The use of Steelcase High-Pressure Laminate may be subject to extended lead times.

*Tip: For a visual palette, please refer to the Steelcase Finish Library.*

#### Fiber Laminate

- 2850 Vanadium Fiber
- 2852 Tungsten Fiber
- 2854 Vellum Fiber
- 2859 Novell Fiber
- 2860 Granite Fiber
- 2861 Coconut Fiber
- 2862 Stucco Fiber

#### Micro Laminate

- 2920 Marl Micro
- 2921 Gypsum Micro
- 2922 Clay Micro

#### Patina Laminate

- 2870 Blonde Bronze Patina
- 2871 Balckened Bronze Patina
- 2873 Instant Iron Patina

#### Solid Laminate

- 2722 Cream
- 2730 Arctic White
- 2746 Black
- 2759 Warm White
- 2811 Mist
- 2883 Seagull
- 2884 Milk
- 2885 Dune
- 2HAA Persian Salt
- 2HAB Rose
- 2HAC Indigo
- 2HAD Green Citrine
- 2HAE Dark Olivine
- 2HAF Cloudy
- 2HMG Merle
- 2HWU Clay
- 2HWV Chalk

#### Speckle Laminate

- 2820 Coffee Speckle
- 2823 Driftwood Speckle
- 2824 Smoke Speckle
- 2825 Vanadium Speckle

#### Textured Laminate

- 2TH2 Fawn Cypress
- 2TH4 Saddle Oak
- 2TH5 Veranda Teak
- 2TH7 Walnut Heights

#### Woodgrain Laminate

- 2406 Clear Cherry
- 2409 Clear Maple
- 2410 Graphite Walnut
- 2412 Natural Cherry
- 2422 Medium Cherry
- 2511 Winter on Maple
- 2535 Virginia Walnut
- 2536 Blackwood
- 2538 Clear Walnut
- 2539 Warm Oak
- 2592 Blonde on Maple
- 2714 Natural Walnut
- 2HAK Clear Oak
- 2HAN Ash Noce
- 2HAT Acacia
- 2HAW Ash Wenge
- 2HBN Bisque Noce
- 2HBW Bisque Wenge
- 2HCN Clay Noce
- 2HCW Clay Wenge
- 2HSN Storm Noce
- 2HSW Storm Wenge
- 2HWA Grey Kingswood
- 2HWB Planked Walnut
- 2HWD Resolute Walnut
- 2HWE Natural Recon
- 2HWF Smoked Walnut

#### Grade 2

##### Textured Laminate

- 2UH1 Reclaimed Aggregate
- 2UH2 Reclaimed Gravel
- 2UH4 Cement\*
- 2UH6 Sheetrock

*\*2UH4 Cement has limited availability, determined by product sizing and/or options.*

#### Grade 3

##### Solid Laminate

- 24H1 Satin White
- 24H2 Satin Black
- 24H3 Satin Stone
- 24H4 Satin Mocha

### Open Line Laminates

Customers can select laminates that are not offered as standard from select suppliers. Standard grade High-Pressure Laminates can be specified in Grade 1 (290A) or Grade 2 (290B) as indicated below (subject to availability). Grade 2 laminates will have extended lead time. Select from any Coalesse or Steelcase standard edge band finishes.

**Contact Customer Service at 1.800.627.6770 to verify that your laminate selection falls within the categories noted below.**

Directional patterns and woodgrains may be used on freestanding systems products, but will not be patterned matched.

Some standard High-Pressure Laminates, may not be available in the appropriate size to produce large products.

Wilsonart (Grade 1)  
Standards (matte finish)  
*Exceptions: High definition which must be quoted as a special.  
Marker board which is grade 2.*

Nevamar (Grade 2)  
Solids (textured finish)  
Patterns (textured finish)

Formica (Grade 2)  
Color portfolio (matte finish)  
Patterns (matte finish)  
Formations (matte finish)

Pionite (Grade 2)  
Decorative surfaces (suede finish)

#### Non-Standard Laminates

Coalesse can supply additional laminates for an upcharge. Contact your Coalesse sales consultant for a custom quotation. Custom upcharges will vary based upon the cost of the material specified and additional labor required to manufacture the products. Some non-standard laminates will not be available in the appropriate size to produce large Coalesse products. A sample of the laminate may be requested for approval. Some non-standard laminates may be subject to extended lead times.

# High-Pressure Laminate Matrix

**Legend**

- = Not available
- = Available
- ▶ See specification pages for details.

	Standard Coalesse High-Pressure Laminate															Standard Steelcase High-Pressure Laminate																		
	2730 Arctic White	2746 Black	2759 Warm White	2826 White Nebula	2829 Poppyseed	2830 Charcoal	2884 Milk	2886 Maple	2887 Amber Cherry	2890 Folkstone	2891 Ingot	2892 Ash	2894 Natural Cork	2895 Natural Walnut	2896 Dark Cork	2897 Desert Oak	2898 Satin Stainless	290N North Sea	2406 Clear Cherry	2409 Clear Maple	2410 Graphite Walnut	2412 Natural Cherry	2422 Medium Cherry	24H1 Satin White	24H2 Satin Black	24H3 Satin Stone	24H4 Satin Mocha	2511 Winter on Maple	2535 Virginia Walnut	2536 Blackwood				
<b>Seating</b>																																		
Await	■	■	■	•	•	•	•	•	•	•	•	•	•	•	•	•	•	•	■	•	•	•	•	•	•	•	•	•	•	•	•	•	•	•
Coupe	■	■	■	•	•	•	■	•	•	■	■	■	•	•	•	•	•	•	■	•	•	•	•	•	•	•	•	•	•	•	•	•	•	•
Sidewalk Tablet	■	■	■	■	■	■	■	■	■	■	■	■	■	■	■	■	■	■	■	■	■	■	■	■	■	■	■	■	■	■	■	■	■	■
<b>Occasional Tables</b>																																		
Await	■	■	■	•	•	•	•	•	•	•	•	•	•	•	•	•	•	•	■	•	•	•	•	•	•	•	•	•	•	•	•	•	•	
Bob Tables	■	■	■	■	■	■	■	■	■	■	■	■	■	■	■	■	■	■	•	■	■	■	■	■	■	■	■	■	■	■	■	■	■	
Circa Tables	■	■	■	■	■	■	■	■	■	■	■	■	■	■	■	■	■	■	•	■	■	■	■	■	■	■	■	■	■	■	■	■	■	
Enea Lottus	■	■	■	■	■	■	■	■	■	■	■	■	■	■	■	■	■	■	•	■	■	■	■	■	■	■	■	■	■	■	■	■	■	
Lagunitas Tables	■	■	■	■	■	■	■	■	■	■	■	■	■	■	■	■	■	■	•	■	■	■	■	■	■	■	■	■	■	■	■	■	■	
Lagunitas Focus Nook	■	■	■	■	■	■	■	■	■	■	■	■	■	■	■	■	■	■	•	■	■	■	■	■	■	■	■	■	■	■	■	■	■	
Montara650	■	■	■	■	■	■	■	■	■	■	■	■	■	■	■	■	■	■	•	■	■	■	■	■	■	■	■	■	■	■	■	■	■	
SW_1	■	■	■	■	■	■	■	■	■	■	■	■	■	■	■	■	■	■	•	■	■	■	■	■	■	■	■	■	■	■	■	■	■	
<b>Tables and Casegoods</b>																																		
Ballet	■	■	■	■	■	■	■	■	■	■	■	■	■	■	■	■	■	■	•	■	■	■	■	■	■	■	■	■	■	■	■	■	■	
E-Table 2 Top	■	■	■	■	■	■	■	■	■	■	■	■	■	■	■	■	■	■	•	■	■	■	■	■	■	■	■	■	■	■	■	■	■	
E-Table 2 Laminate Base	■	■	■	•	•	•	■	•	•	•	•	•	•	•	•	■	•	•	•	■	■	■	■	■	•	•	•	•	■	■	■			
Enea Lottus	■	■	■	■	■	■	■	■	■	■	■	■	■	■	■	■	■	■	•	■	■	■	■	■	■	■	■	■	■	■	■	■	■	
Host Collection	■	■	■	■	■	■	■	■	■	■	■	■	■	■	■	■	■	■	•	■	■	■	■	■	■	■	■	■	■	■	■	■	■	
Montara650	■	■	■	■	■	■	■	■	■	■	■	■	■	■	■	■	■	■	•	■	■	■	■	■	■	■	■	■	■	■	■	■	■	
SW_1	■	■	■	■	■	■	■	■	■	■	■	■	■	■	■	■	■	■	•	■	■	■	■	■	■	■	■	■	■	■	■	■	■	
Train	■	■	■	■	■	■	■	■	■	■	■	■	■	■	■	■	■	■	•	■	■	■	■	■	■	■	■	■	■	■	■	■	■	



# High-Pressure Laminate Matrix *continued*

**Legend**

- = Not available
- = Available
- ▶ See specification pages for details.

	2HAE Dark Olivine	2HAF Cloudy	2HAK Clear Oak	2HAN Ash Noce	2HAT Acacia	2HAW Ash Wenge	2HBN Bisque Noce	2HBW Bisque Wenge	2HCN Clay Noce	2HCW Clay Wenge	2HMG Merle	2HSN Storm Noce	2HSW Storm Wenge	2HWA Grey Kingswood	2HWB Planked Walnut	2HWD Resolute Walnut	2HWE Natural Recon	2HWF Smoked Walnut	2HWU Clay	2HWV Chalk	2TH2 Fawn Cypress	2TH4 Saddle Oak	2TH5 Veranda Teak	2TH7 Walnut Heights	2UH1 Reclaimed Aggregate	2UH2 Reclaimed Gravel	2UH4 Cement	2UH6 Sheetrock
<b>Seating</b>																												
Await	•	•	•	•	•	•	•	•	•	•	•	•	•	•	•	•	•	•	•	•	•	•	•	•	•	•	•	•
Coupe	•	•	•	•	•	•	•	•	•	•	•	•	•	•	•	•	•	•	•	•	•	•	•	•	•	•	•	•
Sidewalk Tablet	•	•	•	•	•	•	•	•	•	•	■	•	•	•	•	•	•	•	•	•	■	■	■	■	■	■	■	■
<b>Occasional Tables</b>																												
Await	•	•	•	•	•	•	•	•	•	•	•	•	•	•	•	•	•	•	•	•	•	•	•	•	•	•	•	•
Bob Tables	■	■	■	■	■	■	■	■	■	■	■	■	■	■	■	■	■	■	■	■	■	■	■	■	■	■	■	■
Circa Tables	■	■	■	■	■	■	■	■	■	■	■	■	■	■	■	■	■	■	■	■	■	■	■	■	■	■	■	■
Enea Lottus	■	■	■	■	■	■	■	■	■	■	■	■	■	■	■	■	■	■	■	■	•	•	•	•	•	•	•	•
Lagunitas Tables	■	■	■	■	■	■	■	■	■	■	■	■	■	■	■	■	■	■	■	■	■	■	■	■	■	■	■	■
Lagunitas Focus Nook	■	■	■	■	■	■	■	■	■	■	■	■	■	■	■	■	■	■	■	■	■	■	■	■	■	■	■	■
Montara650	■	■	■	■	■	■	■	■	■	■	■	■	■	■	■	■	■	■	■	■	■	■	■	■	■	■	■	■
SW_1	■	■	■	■	■	■	■	■	■	■	■	■	■	■	■	■	■	■	■	■	■	■	■	■	■	■	■	■
<b>Tables and Casegoods</b>																												
Ballet	■	■	■	■	■	■	■	■	■	■	■	■	■	■	■	■	■	■	■	■	■	■	■	■	■	■	■	■
Bob	■	■	■	■	■	■	■	■	■	■	■	■	■	■	■	■	■	■	■	■	■	■	■	■	■	■	■	■
E-Table 2 Top	■	■	■	•	•	•	■	■	■	■	■	■	■	■	■	■	■	■	■	■	■	■	■	■	■	■	■	■
E-Table 2 Laminate Base	•	•	■	■	■	■	■	■	•	•	•	•	•	•	•	•	•	•	•	•	•	•	•	•	•	•	•	•
Enea Lottus	■	■	■	■	■	■	■	■	■	■	■	■	■	■	■	■	■	■	■	■	•	•	•	•	•	•	•	•
Host Collection	■	■	■	■	■	■	■	■	■	■	■	■	■	■	■	■	■	■	■	■	■	■	■	■	■	■	■	■
Montara650	■	■	■	■	■	■	■	■	■	■	■	■	■	■	■	■	■	■	■	■	■	■	■	■	■	■	■	■
SW_1	■	■	■	■	■	■	■	■	■	■	■	■	■	■	■	■	■	■	■	■	■	■	■	■	■	■	■	■
Train	■	■	■	■	■	■	■	■	■	■	■	■	■	■	■	■	■	■	■	■	■	■	■	■	■	■	■	■



# High-Pressure Laminate Matrix





# Surface Materials - Glass

## Glass

Not all glass selections are available on every product. Refer to glass matrix for availability by product.

### Back-Painted Glass

6720	Sand
6721	Pewter
6722	Mojave
6723	Terra
6724	Jade
6725	Ocean
ACM	Moonlight
ACS	Sage
ACP	Poppy
ACG	Goldenrod
ACB	Black
ACC	Sea Salt/Crystal Spring

### Glass

6511	Acid Etched
AC	Absolute Clear
CG	Clear Green

Exclusive to EMU products:

6547	Transparent
6548	Smoke Grey

# Glass Matrix

**Legend**

- = Not available
- = Available
- ▶ See specification pages for details.

	6511 Acid Etched	6720 Sand	6721 Pewter	6722 Mojave	6723 Terra	6724 Jade	6725 Ocean	ACM Moonlight	ACS Sage	ACP Poppy	ACG Goldenrod	ACB Black	ACC Sea Salt/Crystal Spring	AC Absolute Clear	CG Clear Green	Green Tinted	Green Tinted with White Enamel Bottom	EMU Exclusive Transparent	EMU Exclusive Smoke	Carl Hansen Exclusive Glass
<b>Occasional Tables</b>																				
Await***	■	■	■	■	■	■	■	■	■	■	■	■	■	■	■	■	•	•	•	•
Bob	■	■	■	■	■	■	■	■	■	■	■	■	■	■	■	■	•	•	•	•
Circa	•	•	•	•	•	•	•	•	•	•	•	•	•	•	•	•	■	•	•	•
Diekman	•	•	•	•	•	•	•	•	•	•	•	•	•	■	•	•	•	•	•	•
EMU Heaven	•	•	•	•	•	•	•	•	•	•	•	•	•	•	•	•	•	■	■	•
Millbrae****	■	■	■	■	■	■	■	■	■	■	■	■	■	■	■	■	•	•	•	•
Sidewalk*	•	•	•	•	•	•	•	•	•	•	•	•	•	•	•	•	•	•	•	•
SW_1***	•	•	•	•	•	•	•	■	■	■	■	■	■	•	•	•	•	•	•	•
Switch	•	•	•	•	•	•	•	•	•	•	•	•	•	•	•	■	•	•	•	•
<b>Conference Tables/Office/Storage</b>																				
Exponents (Credenzas)***	•	•	•	•	•	•	•	■	■	■	■	■	■	■	•	•	•	•	•	•
SW_1***	•	■	■	■	■	■	■	■	■	■	■	■	■	•	•	•	•	•	•	•

\*3/16" thick glass  
 \*\*\*1/2" thick glass  
 \*\*\*\*3/4" thick glass

# Surface Materials - Metal/Paint

## Metal/Paint

Coalesse powder coats all painted metal components for an exceptionally durable, environmentally responsible finish — eliminating VOC's (volatile organic compounds) from being released into the environment. Electrostatically charged powder coat material is applied to an exacting thickness and then temperature baked, resulting in a smooth, flawless finish that is abrasion and impact resistant. The following Coalesse metal finishes are available:

## Paint

### Coalesse Standard Paint—Neutrals

#### Grade 1

##### Standard Coat Paint

- 4138 Graphite Gloss
- 4140 Arctic White Gloss
- 4141 Platinum Matte
- 4142 Platinum Gloss
- 4144 Black Gloss (formerly anthracite gloss)
- 4145 Milk Gloss
- 4146 Champagne Matte
- 4147 Champagne Gloss
- 4148 Midnight Brown Gloss
- 4180 Graphite Matte
- 4193 Midnight Brown Matte
- 4242 Milk Matte
- 4710 Low Gloss Black
- 7196 Midnight Brown Textured
- 7197 Anthracite Textured

### Coalesse Standard Paint—Colors

#### Grade 1

- 4065 Blue Ink Textured
- 4066 Ocean Textured
- 4067 Ice Textured
- 4068 Olive Textured
- 4069 Honey Textured
- 4070 Currant Textured
- 4071 Saffron Textured

### Steelcase Standard Paint

#### Accent Paints

##### Grade 3

Allow customers to add trend-driven color to painted surfaces. We evolve this collection often, to ensure that fresh new colors are always available.

- 1ATG Rose Quartz
- 4AQB Wasabi
- 4AV3 Blue Jay
- 4AV4 Baltic
- 4AX1 Citron
- 4AY2 Chili
- 4AZ5 Marlin
- 4BH7 Canary
- 4CL1 Dark Olivine
- 4CL2 Ice Blue
- 4CL3 Aura
- 4CL4 Sea Glass
- 4CL5 Light Matcha
- 4CL6 Terra
- 4CL7 Sandstone
- 4CL8 Smokey Plum
- 4CZ5 Honey
- 4CZ6 Lagoon

#### Coatings

##### Grade 3

- 1ATT Cast Shadow

## Lux Coatings

### Grade 3

Introduces a softer, more human-centered aesthetic to the workplace. These powder coat paints provide tasteful accent for your spaces.

- 4B20 Obsidian
- 4B22 Matte Brass
- 4B23 Burnished Bronze
- 4B24 Night Bronze
- 4B25 Matte Copper
- 4B26 Smoked Mica
- 4B29 Cast Iron

### Applies to: EMU Advanced Collection\*

- 4251 EMU Brown
- 4257 Antique Iron
- 7234 EMU Black
- 7271 EMU White
- 7272 Blue
- 7273 Green
- 7294 EMU Grey/Green
- 7296 EMU Taupe
- 7297 EMU Corten
- 7391 EMU Poppy

\*Not all colors available on all products as standard, consult EMU advanced paint matrix.

### Applies to: Enea

- 4018 Silver Metallic
- 4016 White Gloss
- 4017 Black Gloss

### Applies to: Enea Lottus

- 4062 Anthracite Grey Textured
  - 4063 Cool Grey Textured
  - 4064 Sand Textured
  - 4216 Red\*
  - 4217 Brown
  - 4218 Platinum Silver
  - 7207 Black Textured
  - 7241 Arctic White Textured
- \*Not available on Enea Lottus tables.

### Applies to: Exponents (Base, Accent Ribbon, Handle, and Grommet)

- 4135 Black Matte
- 4141 Platinum Matte

### Applies to: Exponents mobile displays (Base, Handle, and Inner Frame)

- 4135 Black Matte
- 4145 Milk Gloss

## Metal

### Anodized Aluminum

**Applies to: Rod or disc pulls**  
5200 Satin Aluminum

### Brushed Aluminum

**Applies to: Lox stool**  
9251 Brushed Aluminum

### Polished Aluminum

**Applies to: Lox chair, Potrero415, and Bindu conference bases**  
8046 Polished Aluminum

### Applies to: Bob and SW\_1

8040 Aluminum Matte  
Polished

### Chrome

- 9201 Chrome
- 9207 Polished trivalent chrome
- 9208 Etched trivalent chrome

### Brushed Nickel

**Applies to: Millbrae seating and tables**  
9238 Brushed Nickel

# Surface Materials - Metal/Paint

# Metal/Paint Matrix

**Legend**

- = Not available
- = Available
- ▶ See specification pages for details.

**Seating**

	Coalesse Standard Paint—Neutrals																
	4135 Black Matte	4138 Graphite Gloss	4140 Arctic White Gloss	4141 Platinum Matte	4142 Platinum Gloss	4144 Black Gloss	4145 Milk Gloss	4146 Champagne Matte	4147 Champagne Gloss	4148 Midnight Brown Gloss	4180 Graphite Matte	4193 Midnight Brown Matte	4242 Milk Matte	4710 Low Gloss Black	7196 Midnight Brown Textured	7197 Anthracite Textured	
Bindu Conference	•	•	•	•	•	•	•	•	•	•	•	•	•	•	•	•	
Bindu Guest	•	•	•	•	•	•	•	•	•	•	•	•	•	•	•	•	
Bix	•	■	■	■	■	■	■	■	■	■	•	•	•	•	■	■	
Bob	•	■	•	■	■	■	■	■	■	■	■	■	■	■	■	■	
Capa	•	•	•	•	•	•	•	•	•	•	•	•	•	•	•	•	
Chord	•	•	•	•	•	■	•	•	•	•	•	•	•	•	•	•	
Circa	•	■	■	■	■	■	■	■	■	■	■	■	■	■	•	•	
Coupe	•	■	■	•	■	■	•	•	■	•	•	•	•	•	•	•	
Enea	•	•	•	•	•	•	•	•	•	•	•	•	•	•	•	•	
Enea Lottus	•	•	■	•	■	■	■	•	■	•	•	•	•	•	•	•	
Lagunitas	•	•	•	■	•	•	•	•	•	•	•	•	•	■	•	•	
Lox Stool	•	•	•	•	•	•	•	•	•	•	•	•	•	•	•	•	
Millbrae	•	■	•	■	■	■	■	•	■	■	■	■	■	■	•	•	
Montara650	•	■	•	■	•	■	■	■	•	■	■	■	■	■	•	•	
SW_1	•	•	•	•	•	•	•	•	•	•	•	•	•	•	•	•	
Switch	•	•	•	•	•	•	•	•	•	•	•	•	•	•	•	•	
Visalia	•	■	•	■	•	■	■	•	■	■	■	■	■	■	•	•	
Wrapp	•	•	•	•	•	•	•	•	•	•	•	•	•	•	•	•	

**Occasional Tables**

	Coalesse Standard Paint—Neutrals																
	4135 Black Matte	4138 Graphite Gloss	4140 Arctic White Gloss	4141 Platinum Matte	4142 Platinum Gloss	4144 Black Gloss	4145 Milk Gloss	4146 Champagne Matte	4147 Champagne Gloss	4148 Midnight Brown Gloss	4180 Graphite Matte	4193 Midnight Brown Matte	4242 Milk Matte	4710 Low Gloss Black	7196 Midnight Brown Textured	7197 Anthracite Textured	
Bob	•	■	•	■	■	■	■	■	■	■	■	■	■	■	•	•	
Circa	•	■	■	■	■	■	■	■	■	■	■	■	■	■	•	•	
Enea Lottus	•	•	■	•	■	■	■	•	■	•	•	•	•	•	•	•	
Lagunitas	•	■	■	■	■	■	■	■	■	■	■	■	■	■	■	■	
Lagunitas Focus Nook	•	■	■	■	■	■	■	■	■	■	■	■	■	■	■	■	
Millbrae	•	■	•	■	•	■	■	•	■	■	■	■	■	■	•	•	
Montara650	•	■	•	■	•	■	■	■	•	■	■	■	■	■	•	•	
Switch	•	•	•	•	•	•	•	•	•	•	•	•	•	•	•	•	
SW_1	•	•	•	•	•	•	•	•	•	•	•	•	•	•	•	•	

	Coalesse Standard Paint—Colors																
	4065 Blue Ink Textured	4066 Ocean Textured	4067 Ice Textured	4068 Olive Textured	4069 Honey Textured	4070 Currant Textured	4071 Saffron Textured	Product Line Exclusives									
	LessThanFive	LessThanFive Essential	Enea Exclusive Finishes	Enea Café Wood Exclusive Finishes	Enea Lottus Exclusive Finishes												
4065 Blue Ink Textured	•	•	•	•	•	•	•	•	•	•	•	•	•	•	•	•	
4066 Ocean Textured	•	•	•	•	•	•	•	•	•	•	•	•	•	•	•	•	
4067 Ice Textured	•	•	•	•	•	•	•	•	•	•	•	•	•	•	•	•	
4068 Olive Textured	•	•	•	•	•	•	•	•	•	•	•	•	•	•	•	•	
4069 Honey Textured	•	•	•	•	•	•	•	•	•	•	•	•	•	•	•	•	
4070 Currant Textured	•	•	•	•	•	•	•	•	•	•	•	•	•	•	•	•	
4071 Saffron Textured	•	•	•	•	•	•	•	•	•	•	•	•	•	•	•	•	
LessThanFive	•	•	•	•	•	•	•	•	•	•	•	•	•	•	•	•	
LessThanFive Essential	•	•	•	•	•	•	•	•	•	•	•	•	•	•	•	•	
Enea Exclusive Finishes	•	•	•	•	•	•	•	•	•	•	•	•	•	•	•	•	
Enea Café Wood Exclusive Finishes	•	•	•	•	•	•	•	•	•	•	•	•	•	•	•	•	
Enea Lottus Exclusive Finishes	•	•	•	•	•	•	•	•	•	•	•	•	•	•	•	•	







# Metal/Paint Matrix

Coalesse Metals												Custom Paint		Steelcase Standard Paint		Accent Paints		Coatings*		Lux Coatings*	
8040 Aluminum Matte Polished	8046 Polished Aluminum	9201 Chrome	9207 Polished Trivalent Chrome	9208 Etched Trivalent Chrome	9238 Brushed Nickel	9251 Brushed Aluminum	9260 Black Chrome	9261 Copper	Potrero415 Exclusives	PerfectMatch Custom Color	Steelcase Standard Paint	Accent Paints	Coatings*	Lux Coatings*							
•	•	•	•	•	•	•	•	•	•	•	•	•	•	•	•	•	•	•	•	•	•
■	•	•	•	•	•	•	•	•	•	■	•	•	•	•	•	•	•	•	•	•	•
•	•	•	•	•	•	•	•	•	•	•	•	•	•	•	•	•	•	•	•	•	•
•	•	•	•	•	•	•	•	•	•	•	•	•	•	•	•	•	•	•	•	•	•
•	•	•	•	•	•	•	•	•	•	•	•	•	•	•	•	•	•	•	•	•	•
•	•	•	•	•	•	•	•	•	•	•	•	•	•	•	•	•	•	•	•	•	•
•	•	•	•	•	•	•	•	•	•	•	•	•	•	•	•	•	•	•	•	•	•
•	•	•	•	•	•	•	•	•	•	•	•	•	•	•	•	•	•	•	•	•	•
•	•	•	•	•	•	•	•	•	•	•	•	•	•	•	•	•	•	•	•	•	•
•	•	•	•	•	•	•	•	•	•	•	•	•	•	•	•	•	•	•	•	•	•
•	•	•	•	•	•	•	•	•	•	•	•	•	•	•	•	•	•	•	•	•	•
•	•	•	•	•	•	•	•	•	•	•	•	•	•	•	•	•	•	•	•	•	•
•	•	•	•	•	•	•	•	•	•	•	•	•	•	•	•	•	•	•	•	•	•

\* Lux Coatings and Coatings are not available on Montara650 54" or 60" round work-height tables.



# EMU Advanced Collection Paint Matrix

Legend

- = Not available
- = Available
- ▶ See specification pages for details.

	4251 EMU Brown	7234 EMU Black	7271 EMU White	7272 Blue	7273 Green	7294 EMU Grey/Green	7296 EMU Taupe	7297 EMU Corten	7391 EMU Poppy
Heaven Seating, Tables, and Pouf	•	■	■	•	•	•	•	•	•
Heaven Vases	•	•	■	•	•	•	•	•	•
Round Collection	■	■	■	•	•	•	•	•	•

*Tip: Select product lines allow for other EMU paint finishes (those shown as not available on the matrix) as an available option. Consult the Coalesse Seating and Outdoor Specification Guide for details.*

# Surface Materials - Miscellaneous

## Convex Vinyl Edge Band

Applies to:

- E-Table 2:
- 6000 Black
- 6607 Woodrose
- 6609 Smoke
- 6655 Warm White

## Plastic

Applies to:

- Enea
- 003 White
- 0013 Sunset Orange
- 0014 Clover Green
- 0015 Sand
- 0016 Walnut Brown
- 0017 Cool Grey
- 0400 Black
- 0405 Periwinkle
- 0406 Alabaster
- 0409 Red
- 0414 Anthracite Grey
- 0421 Blue

Applies to:

- Enea Lottus
- 003 White
- 0013 Sunset Orange
- 0014 Clover Green
- 0015 Sand
- 0016 Walnut Brown
- 0017 Cool Grey
- 0400 Black
- 0409 Red
- 0414 Anthracite Grey
- 0421 Blue
- 0422 Blue Ink
- 0423 Ocean
- 0424 Ice
- 0425 Olive
- 0426 Honey
- 0427 Currant
- 0428 Saffron

*Tip: Not all colors available on all products. Consult the Enea plastic matrix for product line availability.*

Applies to:

- Exponents and mobile display casters
- 6000 Black
- 6009 Arctic White

Applies to:

- Lox stools
- 6347 Black Gloss
- 6348 White Gloss

Applies to:

- SW\_1 tablets, grommet, barrier, wire manager, sub-structure, lounge tablet, Sebastopol grommet
- 6000 Black
- 6052 Milk

Applies to:

- Grommet, spheres, flex-gangers, Mini-Port, Interport, casters, horizontal wire manager, and vertical wire manager
- Black plastic

Applies to:

- Lagunitas focus nook
- 6000 Black
- 6052 Milk
- 6D03 Graphite

## TAP Power Module Door Finishes

### Brushed Anodized Aluminum

Applies to:

- Host
- 8043 Silver
- 8044 Black

## Utility Bay

Applies to:

- E-Table 2
- 4137 Matte Black
- 4745 Nickel Mica
- 4746 Silver Mica
- 4747 Charcoal Mica

## Locks

Applies to:

- Exponents
- 9211 Nickel
- 9250 Ember Chrome

## Solid

Applies to:

- Exponents and SW\_1 tables
- 2801 Glacier White

## Grommet

Applies to:

- Exponents
- 4135 Black Matte
- 4141 Platinum Black

## Power, Voice Data Modules

Applies to:

- Exponents
- 4140 Arctic White Gloss
- 4141 Black Gloss

## Glossy Laminate

Applies to:

- Sebastopol
- 2001 Smoky White Glossy
- 2002 Studio Grey Glossy
- 2003 Wrought Iron Glossy
- 2004 Black Pearl Glossy
- 2005 Liberty Red Glossy

# Ordering

## How to Order

Coalesse furniture is available through authorized dealers and retailers. Select products are available for order from our web site. The authorized dealer can help you with everything from surface material selection and order placement, to specialized services, such as space planning and design, delivery and installation. Best of all, they are part of your local community, providing expert advice with a thorough understanding of local needs. For more information and a listing of dealers and retailers, visit [www.coalesse.com](http://www.coalesse.com) or call 1.800.627.6770.

Coalesse reserves the right to limit distribution of any or all models.

## Credit, Prices, and Terms

Credit may be established upon acceptance of satisfactory references. For payment terms, contact Coalesse's Credit Department. Coalesse may cancel or change credit terms at its discretion and may request advance payment at any time.

The order confirmation will be deemed by the customer and by Coalesse, as the final expression of agreement and will be deemed the exclusive statement of terms. The order confirmation supersedes all prior writings and may not be modified or rescinded, except by a revised Coalesse order confirmation signed by the customer. No changes are binding on Coalesse until delivery of the order confirmation.

Any storage charges and applicable sales taxes are in addition to the prices shown for merchandise. Inside delivery, uncartoning and installation are customer's responsibility unless separately quoted. All list pricing shown includes freight prepaid to one destination for delivery in the 48 contiguous United States. Hawaii and Alaska are not included. We reserve the right to increase prices without notice due to increases in labor and material costs. If timely payment is not made, customer is liable for reasonable collection costs, including attorney's fees.

## Shipping and Storage

Coalesse reserves the right to select carrier and packaging method. Partial shipments may be delivered. Coalesse is not liable for delays or delivery failure due to strikes, lockouts, labor, or transportation difficulties, failure or delay of supply sources, accidents, fire, acts of God, or any other cause of like or unlike nature beyond Coalesse's control. Coalesse may transfer merchandise to storage if not accepted when shipment scheduled. Transfer and storage charges will be the customer's expense. Coalesse's invoice is payable upon transfer. If transfer is made prior to confirmed shipping date, storage expenses will be borne by customer.

Shipping charges MAY be calculated per order. Lead-times vary by product. Coalesse reserves the right to select carrier. Partial shipments may be delivered. Coalesse will make every effort to provide current and accurate lead-time information, however, Coalesse is not liable for delays or delivery failure due to strikes, lockouts, labor, or transportation difficulties, failure or delay of supply sources, accidents, fire, acts of God, or any other cause of like or unlike nature beyond Coalesse's control.

Freight is included on domestically manufactured products within the 48 contiguous states of the United States and standard freight service of Carl Hansen & Søn and EMU.

## Claims

Merchandise shipped from Coalesse is thoroughly inspected and properly packed before leaving the factory. Responsibility of its safe delivery is assumed by the carrier at the time of shipment. Customer must match the freight delivered with the bill of lading. Customer must examine packaging material upon delivery and note any damage on the carrier bill of lading. If there is damage to the packaging material, inspect the furniture immediately. If concealed damage is found, contact the carrier within 10 days of delivery date. Save all packaging materials until after inspection.

Freight damage and claims must be reported by the purchaser to the carrier. Coalesse is not responsible for freight claims. Claims for loss or damage must not be deducted from our invoice, nor payment withheld awaiting adjustment of such claims. Do not return any merchandise to Coalesse without a Return Authorization number. By following these procedures carefully, Coalesse guarantees our full support of your claims to protect you against loss or damages. All claims against Coalesse for defects, errors or shortages must be made by customer in writing within ten (10) days after delivery. Failure to make claims within ten (10) days constitutes acceptance of merchandise and waives claims. Cutting of textiles deems acceptance of yardage and waives all defects, errors, and shortages. Coalesse is not liable for subsequent damages.

## Special/Custom Products

Coalesse prides itself on being responsive to our customer's needs. Contact our Customer Service team at 1.800.627.6770 to discuss a special opportunity. Due to product modifications and engineering time, special orders may not be cancelled. Charges will apply.

FOR MORE INFORMATION (on ordering our products) Please contact Coalesse Customer Service at: 1.800.627.6770.

## Order Cancellations/Changes

All order change/cancellation requests must be submitted using the Coalesse order change/cancellation request form. Late changes could jeopardize the committed delivery of an order.

Rapid10 program, no change or cancellations allowed.

### Coalesse Products:

- No charges will be assessed for change or cancellation 14 or more calendar days prior to the manufacturing completion date (excludes holidays and/or large quantity project size orders). For import products, charges may apply.

- No manufacturing changes are allowed 0-13 calendar days prior to the manufacturing completion date. Simple changes including shipping address changes are subject to approval but will be accommodated when possible.

- No cancellations or product changes will be accepted for quick ship or special/custom product orders including special laminates. A cancellation fee will be applicable for any custom product and/or change may jeopardize lead time.

- If COM/COL has been received at time of change or cancellation, it is the dealer's responsibility to advise disposition or return of materials. Coalesse will not store materials after 30 days.

## Additional Charges

- Changes or cancellations that involve any of the following may be subject to a charge earlier and/or greater than shown above: Special engineering product, CSM, pre-ordered components, materials with extended lead times (e.g., veneers, special paint, etc.) or large quantities of standard materials.

- Use our Order Change/Cancellation Request Form for all order changes. It is Coalesse responsibility to accurately process change order requests. It is the dealer's responsibility to verify that we have accurately interpreted your change requests by checking the acknowledgment after the change has been made. If you do not use the web-based change order form process and an error occurs during our translation which cannot be corrected prior to ship, all costs will be shared on a 50/50 basis. Changing ship dates or adding product to your order is subject to the availability of manufacturing capacity.

- Cartoning changes and shipping address changes are subject to approval and to a change charge. Please consult your Customer Service for specific information pertaining to your order.

## Reserved Fabric Policy

Prior to order receipt, reserving textiles (COM/COL, Maharam, Designtex, and select Luna Select Surfaces) is the responsibility of the dealer. Coalesse cannot reserve textiles based on projected orders. Coalesse cannot guarantee Maharam or Designtex fabric availability. If dealer reserves Maharam or Designtex textiles, Coalesse will require the reserve number and zip code for locating purposes when ordering.

## Schedule Enhancements

Coalesse will entertain schedule enhancements on a case-by-case basis; however, please understand that we must receive complete information such as installation date, opening date, etc., to make informed scheduling decisions.

No order move-ups or move-outs are allowed on any order that falls within the 15-working day period of its manufacturing completion date. If it is within the 15-working day period, Coalesse will invoice at shipment but may offer storage options at a charge for manufactured product.

# Ordering

## Surface Materials

### ELMOSOFT, ELMORUSTICAL LEATHER CARE

Only the finest hides are used for Elmo leather. Expect some color variations from hide to hide due to the aniline state of the product. Color fading may occur if leather is exposed to direct or intense light. Care is required to allow this product to achieve the rich natural patina that beautiful natural leather develops. The hallmarks of this leather include some naturally occurring markings, such as healed scars, insect bites, stretch marks, and fat wrinkles. Elmorustical's leather treatment is very natural with little protection from spills or body oils. This rich leather will exhibit stains and oils through normal use. Coalesse is not responsible for discoloration, spotting, or staining on this leather.

### Special Color Match Leather

Coalesse can provide a special color match in its leather to any supplier's leather color, paint color, carpet color, wall-paper color, etc. Sample to match must be submitted to Coalesse with purchase order. Sample for approval can be supplied if requested.

*Note: Minimum order 2,500 sq. ft.*

## Special Fabric Applications

### Backing\*

• Backing information is found on each product page in the Coalesse Specification Guides. Select this option when ordering your product to have backing applied. Price varies by product according to yardage it requires.

\*Prices subject to change without notice and an additional two week lead time will apply for 54" wide fabrics. Wider fabrics will require four week additional lead time. \*Check fabric database to determine if backing is required at [www.Coalesse.com](http://www.Coalesse.com).

### Upholstery

All Coalesse textiles are priced by grades. Some Coalesse fabrics can be treated for flame retardancy, contact Customer Service. All Coalesse products are handcrafted making each unique. Certain fabrics and leathers will appear loose and may differ from like products due to comfort wrinkles when upholstered.

A contrasting welt is available on some products. Consult Customer Service for yardage or square feet requirements and prices. All stripes will be applied vertically unless customer specifies otherwise. Loose cushions on Coalesse products are not fully upholstered (not reversible).

Designtex, Maharam, and select Luna fabrics are graded in our pricing. Simply order Coalesse products with Designtex, Maharam, and select Luna specified. Designtex and Maharam fabrics are graded in on Coalesse products; however, Coalesse does not stock fabrics and can only respond based on Designtex and Maharam lead times. For current grades, refer to Coalesse website: [www.Coalesse.com](http://www.Coalesse.com).

Pre-approved CAL 133 Textiles Designtex and Maharam textiles have been graded into our pricing; however, not all textiles are recommended on all seating. For current grade and approval information, please visit our website and click on FABRICEVALUATIONS to obtain grade pricing for a specific pattern.

## Wood and Finish Specifications

Solid hardwood is a renewable natural resource, and each section of a tree is unique. The color and grain pattern will vary emphasizing the natural beauty of each product built. Wood is a natural material and will accept stain differently. Coalesse cannot guarantee finished products to be an exact match to finish samples due to the natural characteristics of wood. Light finishes will exhibit some mineral streaks and dark graining due to the natural wood.

The finish used by Coalesse on hardwood frames and occasional tables is pre-catalyzed lacquer which can be easily repaired in the field if damage occurs. Veneer is sanded prior to finish application, and sanded between coats. The lacquer top coat is then polished after final application with wool wax. 4 to 6 layers of finish are applied during the process. The CH process varies from our internal processes.

## Coalesse Tables and Casegoods

Coalesse's primary wood finish, Clarity, is a water-borne UV topcoat, which protects the environment while providing exceptional durability and resistance to water and chemical stains. contoured products, such as wood guest chairs & occasional tables, are finished with post-catalyzed vinyl, which provides similar properties and matches the sheen and color of Clarity, due to natural variations in wood, finished products may vary from samples in color, texture, and grain.

## Stain-To-Match Program

Coalesse will offer a stain to match program at no additional upcharge for all products with wood finish options.

Customer must supply Coalesse Customer Service with sample to be matched. (internal note - CSR's will have samples of bare wood to compare and define species when applicable that will be used to accomplish the closest stain to match).

Coalesse high sheen will be standard unless specified by customer.

Sheen to match is available as part of the stain/sheen to match program at no upcharge.

Species to match is considered a special and requires to special request to Coalesse Customer Service. Species to match may require an upcharge.

# Care and Maintenance

## Chrome

Use commercial cleanser and polish, according to manufacturer's directions.

## Fabric

Under normal use, clean with soft cloth dampened with water. For spots and spills, we recommend professional cleaning. For COM, refer to the specific cleaning instructions recommended by the fabric supplier.

### EMU Outdoor Fabric:

Remove loose dirt with soft bristle brush or hose down with cold water. Clean with mixture of water and mild soap. Rub in mixture with soft brush and allow to thoroughly soak into fabric. Rinse thoroughly with cold water and air dry. Never use water over 100 degrees Fahrenheit. Do not machine dry. For light cleaning, avoid using detergents.

For stubborn stains use mixture of one gallon cold water, ½ cup bleach and ¼ cup mild soap for one hour.

Detergents can be used without harm, though they may remove some of the water and stain resistant properties in the fabric.

### SW\_1 Knit:

Clean with warm water and soap. Wet sponge and wipe fabric. Household cleaners such as Windex™ may be used. Do NOT use cleaners containing bleach.

**Laminate and solid phenolic** should be cleaned with soap and water. For stubborn stains, use a non-abrasive household cleaner.

**SW\_1 Tablet** surfaces clean with soft cloth dampened with water and soap, if needed. The use of general purpose cleaners are acceptable but must be void of citric content that has z-butoxyethanol in the formulation listing.

## Cleaning Laminate

### Markerboard Surface

Use dry erase markers only. Remove dry-erase markings with a markerboard eraser or soft cloth as often as possible. Change erasers, as they become dirty. Dirty erasers will leave ink residue on the surface.

For daily cleaning, or as needed, use a dry erase cleaner, or a non-abrasive household cleaner, such as glass cleaner. This may be done with a soft cloth or sponge. Dry the surface with a soft cloth prior to writing. All markings should be removed weekly.

### Caution:

- Do not use permanent markers on markerboard surfaces. In the event a permanent marker is used, removal of markings may be attempted by using dry erase cleaner, or by writing over the marking with a dry erase marker and erasing with a markerboard eraser or soft cloth.
- Do not use abrasive cleaners or solvent type cleaning solutions, such as Ketones (Acetone, MEK, etc.) lacquer thinner, nail polish remover, etc. because they may remove the finish from the markerboard surface.

## Cleaning CeramicSteel

### Markerboard Surface

- Care and maintenance applies to both a<sup>3</sup> CeramicSteel and e<sup>3</sup> CeramicSteel.
- Wipe board with a clean cloth moistened by a liquid markerboard cleaner or a solution of 50% water and 50% isopropyl alcohol.
- Rinse with clear water.
- Wipe dry with a clean cloth. If your board is used daily, the cleaning should be performed at least 2-3 times a week.

More thorough cleaning may be required if writing is left on the board for more than two days.

## Markers

Use any high-quality dry erase marker.

**CAUTION!** The use of Low Odor markers may cause ghosting to occur. If Low Odor markers have been used, the surface can be completely cleaned by following the cleaning instructions above. Remember to discard eraser if used with Low Odor markers.

### Removing Permanent Marker

- Option 1:
- Write over the top of the permanent marker ink with a dry-erase marker
  - Simply erase

### Option 2:

- Moisten a clean, dry cloth with isopropyl alcohol
- Wipe the board in a circular motion to loosen marker residue
- Rinse with clear water
- Dry the board with a clean cloth
- Repeat these steps as necessary

### Installer's Instructions for Initial Cleaning at Time of Installation

NOTE: These initial cleaning instructions are shipped with every board.

- For initial cleaning, wipe your board with a clean cloth moistened by a mild, alcohol-based cleaner.
- Rinse with clear water. This step is simple, but very important.
- Wipe dry with a clean cloth.

## Leather

Under normal use, regular dusting and vacuum cleaning are all that is necessary. For spots and spills, wipe excess liquid immediately. If necessary, use lukewarm water cleaning the entire area where spot occurred and air dry. For stubborn spots or stains, use a solution of mild non-detergent soap and air dry. For butter, oil, or grease, wipe excess with dry cloth and then leave alone. The spot will dissipate into the leather. Do not apply water.

## Faux Leather

Under normal use, clean with soft cloth dampened with water. For spots and stains, use the recommended mixture of Woolite and water. Rinse with clean water and air dry.

## Granite/Glass

Under normal use, clean with Windex and soft cotton cloth.

### Powder coat finishes on chairs and table bases

should be cleaned with a liquid detergent and water. Remove stubborn stains with liquid cleanser, such as Formula 409.

### EMU Outdoor Paint:

Store in an enclosed and dry area during winter to avoid condensation. Before winter and regularly every quarter, clean the metal surfaces with a cloth dipped in water or detergent and protect them with vasoline oil or car polish. Do not use ethyl alcohol or detergents that contain even in small quantities acetone, trichloroethylene, or ammonia (or solvents in general). When storing tables, do not stack them or put the table tops in direct contact with each other. Handle the seats with care when stacking them to avoid damaging the varnished surfaces.

### Polished Aluminum finishes

on table bases should be cleaned with a commercial powder, liquid, or paste metal cleaner and polish. Follow the manufacturer's directions.

### Veneers and painted MDF

should be cleaned regularly with mild soap and water and dried with a soft cloth. *Tip: Never use ammonia-based cleaners or wax on wood surfaces.*

**Veneers** should be cleaned regularly with mild soap and water and dried with a soft cloth.

*Tip: Never use ammonia-based cleaners or wax on wood surfaces.*

## Protecting Wood Surfaces

Use desk pads and coasters to help protect the finish against dents, scratches, moisture and hot and cold liquids. Do not use desk pads that have plastic backing. Use felt or leather pads on the bottoms of office equipments and accessories.

Periodically move desk accessories and other objects kept on the worksurface to ensure even aging.

Lift objects when you move them, instead of pulling or pushing them across the surface, to avoid scratching the surface. Avoid leaving vinyl binders on worksurface for long periods.

If you use a protective glass top, insert felt pads between the glass and the worksurface to create an air space and allow the wood to breathe.

Keep your furniture away from direct sunlight. Avoid extreme temperatures and humidity. Maintain temperatures between 60 and 80 degrees Fahrenheit and humidity levels between 30 and 50 percent.

### Cleaning Wood Surfaces

Keep a supply of soft, clean, absorbent cloths handy for wiping up spills and regular dusting.

To dust, wipe with a slightly damp, soft cloth, using another soft cloth to dry. Always wipe the surface in the direction of the woodgrain.

Use a quality cleaner or flax soap formulated especially for use on wood surfaces. Do not use oils or ammonia. Dilute the cleaner as directed by the manufacturer. Dampen but do not saturate a soft cloth with the diluted cleaning solution. Wipe the surface in the direction of the woodgrain to remove dirt and fingerprints. Wipe the surface clean with a soft, dry cloth.



# Care and Maintenance

**Vinyl**

Under normal use, clean with soft cloth dampened with mild soap solution. For stubborn stains and spills, a sponge or soft brush may be used with mild non-abrasive cleaner.

**Transolid/Corian:**

Clean regularly with mild soap and water. Dry with a soft cloth.

**Tables should be inspected and maintained regularly** by tightening screws and bolts, inspecting casters and glides for damage, and inspecting all moving parts for damage and wear.



---

# Resources



Lock and Keying	236
Style Number Index	238

# Lock and Keying

All locking products are standard with factory-installed, keyed-random locks. Consecutive, specific, and random keying are available as field-installed options. *Exceptions: Individual locking drawers are only available with field-installed locks. Overfiles are only available with factory-installed locks.*

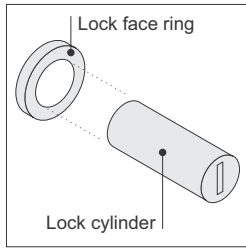

Locks consist of a factory- or field-installed lock cylinder and a factory-installed lock face ring.

Two types of locks are available—the standard keying system (FR series) and the master keying system (XF series). All the locks in the XF series can be opened with a single master key.

## Factory-Installed Keying

Factory-installed locks are always key random (standard) or master key random (option). Key random means that the locks will be assigned arbitrarily at the factory with key numbers ranging from FR305 to FR999 (Master keying numbers: XF1001 to XF3000). All locks within a unit will be keyed alike.

*Tip: Random keying can mean that different furniture units will have the same key number. If you must have all locks keyed differently, you should specify field-installed, key specific or key consecutive lock cylinders.*

▶ See example at right

### Key Random

FR305

FR421

FR305

or

XF1011

XF1042

XF1011

XF  
Master  
Key

### Required to Specify

<b>Master key random</b>	+ \$33	Specify with master key random.
--------------------------	--------	---------------------------------

## Field-Installed Keying

Field-installed locks are only available on products that include factory-installed lock mechanisms.

Specify "plug" when specifying furniture, and the product will ship without the lock cylinder.

*Tip: Lock tools are reusable. You do not need to order additional lock tools with every furniture order.*

Lock cylinders will be shipped separately so that you can install the locks when you are ready.

Front-removable lock cylinders must be specified separately. You must also order a special lock tool to install or remove lock cylinders in the field.

Three keying choices are available for field installation—random (standard), specific, and consecutive. All three are also available with master keying, which means that all locks can be opened with a single master key.

Key random means that the locks will be assigned arbitrarily at the factory with key numbers ranging from FR305 to FR999 (Master keying numbers: XF1001 to XF3000).

*Tip: Random keying can mean that different furniture units will have the same key number. If you must have all locks keyed differently, you should specify key specific or key consecutive lock cylinders.*

Key specific means that you can specify any key number from FR305 to FR999 (Master keying numbers: XF1001 to XF3000). This option can be used to key all the furniture units in a workstation or department the same.

*Tip: Designate the quantity per key number in your specification.*

▶ See below.

Key consecutive means that you can specify lock numbers in a consecutive order to ensure that no two locks have the same key number until the key sequence repeats. You must select a beginning key number from FR305 to FR999 (Master keying numbers: XF1001 to XF3000).

Example of a typical lock cylinder specification is shown below:

10	LOCKFR FR320
5	LOCKFR FR350
15	LOCKXF XF1100

30	Total
1	877102003SR standard lock tool
1	877102002SR master lock tool

### Key Random

FR305

FR421

FR305

or

XF1011

XF1042

XF1011

XF  
Master  
Key

### Key Specific

FR350

FR350

FR350

or

XF1020

XF1020

XF1020

XF  
Master  
Key

### Key Consecutive

FR350

FR351

FR352

or

XF1020

XF1021

XF1022

XF  
Master  
Key

# Lock and Keying

## Field-Installed Lock Cylinders

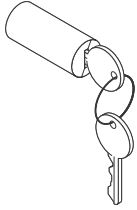

Tip: Lock price is included in price of furniture with locks.

Standard Includes	Required to Specify
<ul style="list-style-type: none"> <li>• Lock cylinder</li> <li>• Two keys</li> </ul>	1 Style number 2 Lock finish 9201 Polished Chrome 9250 Ember Chrome 3 Options, if selected (see below)

Options	Price	Required to Specify
Key specific	No cost	Select key number from FR305–FR999.
Key consecutive	No cost	Specify <i>key consecutive</i> and must select beginning key number from FR305–FR999.
Master key random	+\$33 each	Specify master key random.
Master key specific	+\$33 each	Specify key number from XF1001–XF3000.
Master key consecutive	+\$33 each	Specify <i>master key consecutive</i> and must select beginning key number from XF1001–XF3000.

### Specification Information

Style Number	Base Price
--------------	------------

#### FR Series (Standard Keying System)—Lock Cylinder

LOCKFR	No cost
--------	---------

#### Standard Lock Tool

877102003SR	\$33
-------------	------

#### XF Series (Master Keying System)—Lock Cylinder

LOCKXF	No additional cost. Price included in price of furniture with master-keyed locks.
--------	---

#### Master Lock Tool

877102002SR	\$33
-------------	------

Tip: For replacement lock cylinders, refer to Service Parts.

Tip: You can change lock cylinders in the field by using the appropriate lock tool.

# Style Number Index

Style Number	Page	Description	Style Number	Page	Description
1404M	158	Switch Counter-Height Stool	45-T3730HG	59	Circa Ganging Table
1404PC	158	Switch Counter-Height Stool	45-T3730LER	59	Circa Ganging Table
1405M	158	Switch Bar-Height Stool	45-T3730LG	59	Circa Ganging Table
1405PC	158	Switch Bar-Height Stool	45-T42RD	61	Circa Freestanding Table
1500M	157	Switch Guest Armless Chair	451-2500	54	Circa Straight Seat Chair
1500PC	157	Switch Guest Armless Chair	451-3730FI	53	Circa 30° Inside Wedge Armless Seat
1510M	157	Switch Guest Arm Chair	451-3730FO	52	Circa 30° Outside Wedge Seat
1510PC	157	Switch Guest Arm Chair	451-5000	54	Circa Straight Loveseat
1810M	142	Capa Chair	451-7460FI	53	Circa 60° Inside Wedge Loveseat
1810PC	142	Capa Chair	451-7460FO	53	Circa 60° Outside Wedge Loveseat
216	50	Bob Lounge Swivel Chair	451-A1800ER	56	Circa Straight Armrest
221	50	Bob Lounge Chair w/Headrest	451-A1800G	56	Circa Straight Armrest
221-H	51, 141	Bob Ottoman	451-A1815FIER	56	Circa 15° Inside Armrest
231	141	Bob Guest Chair	451-A1815FIG	56	Circa 15° Inside Armrest
2540-1	154	Kathryn Wood with Open Back	451-A1815FOER	57	Circa 15° Outside Armrest
2542-1	154	Kathryn Wood/Uph with Panel Back	451-A1815FOG	57	Circa 15° Outside Armrest
2547-1	154	Kathryn Fully Uphol Back	451-A3730FIER	57	Circa 30° Inside Armrest
2547-1RIBD	155	Kathryn Fully Uphol Back w/Ribbed uph	451-A3730FIG	57	Circa 30° Inside Armrest
391	124	Switch Chair	451-A3730FOER	57	Circa 30° Outside Armrest
391-2	124	Switch Two-Seat	451-A3730FOG	57	Circa 30° Outside Armrest
391-3	125	Switch Three-Seat	451-B42RD	57	Circa Round Ottoman
391-4	125	Switch Two-Seat w/Extensions	451-B5000	54	Circa Straight Bench
391-B	125	Switch Arm Bolster	451-B7460FI	53	Circa 60° Inside Wedge Bench
430	74	Sidewalk Collaborative Chair	451-B7460FO	53	Circa 60° Outside Wedge Bench
430-2	75	Sidewalk Collaborative Two-Seat	451-GANGPKG	54, 57	Circa Ganging Kit
430-B1724	76	Sidewalk Bench	46-T1	178	Await Freestanding Table
430-B1736	76	Sidewalk Bench	46-T2	178	Await Freestanding Table
430-B1748	76	Sidewalk Bench	460-3	35	Await Modular Three-Seat Lounge
430-H1717	75	Sidewalk Collaborative Ottoman	460-4	35	Await Modular Four-Seat Lounge
430-H1720	75	Sidewalk Collaborative Ottoman	460-4B	35	Await Modular Four-Seat Bench
430-H2026	75	Sidewalk Collaborative Ottoman	460-GANGPKG	36	Ganging Kit
430-H3636	76	Sidewalk Ottoman	460-H	35	Await Modular Ottoman
440-2WB	120	Passerelle Two-Seat Lounge	460-SE22	37	Await Lounge Table
440-3WB	121	Passerelle Three-Seat Lounge	460-SE22PD	37	Await Lounge Table
440-B	71, 121	Passerelle Arm Bolster	460-SE30	37	Await Lounge Table
440-B2060WB	122	Passerelle Bench	460-SE30PD	37	Await Lounge Table
440-B3060WB	122	Passerelle Bench	460-SE44	37	Await Lounge Table
440-WB	120	Passerelle Chair	460-SE44PD	37	Await Lounge Table
444	70	Sidewalk Lowback Chair	461-1B	36	Await Connector Bench
444-2	71	Sidewalk Two-Seat	461-2B	36	Await Connector Bench
444M	71	Sidewalk Lowback Chair w/Tablet	461-3B	36	Await Connector Bench
446	71	Sidewalk Highback Chair	470	63	Coupe Lounge Chair
446M	71	Sidewalk Mobile Highback Chair w/Tablet	476	64	Coupe Grande Chair
45-T1300H	60	Circa Freestanding Table	476M	64	Coupe Grande Chair
45-T1300HER	59	Circa Ganging Table	490-B35HRZ	69	Ripple Bench
45-T1300HG	59	Circa Ganging Table	490-B35VRT	68	Little Ripple Wave Bench
45-T1300LER	59	Circa Ganging Table	490-B96HRZ	68	Ripple Flat Seat Bench
45-T1300LG	59	Circa Ganging Table	490-B96VRT	68	Ripple Wave Bench
45-T1815H	58	Circa Freestanding Table	70-C-TPM	185	Tree Bevel High-Embossed Wood
45-T1815HER	58	Circa Ganging Table	70-D-TPM	185	Tree Bevel Medium-Embossed Wood
45-T1815HG	58	Circa Ganging Table	795	172	Chord Conference Chair
45-T1815LER	58	Circa Ganging Table	795AU	172	Chord Conference Chair
45-T1815LG	58	Circa Ganging Table	796	173	Chord Midback Chair
45-T28HER	60	Circa Ganging Table	796-P	173	Chord Midback Chair
45-T3730HER	59	Circa Ganging Table	796-PAU	173	Chord Midback Chair

## Style Number Index

Style Number	Page	Description	Style Number	Page	Description
796AU	173	Chord Midback Chair	CO2495V	189	Emu Heaven Glass Top
797	173	Chord High Back Chair	CO2496	190	Emu Heaven Side Table
797AU	173	Chord Midback Chair	CO2497	189	Emu Heaven High Vase
798	173	Chord High-Back Chair	CO2498	189	Emu Heaven Low Vase
798-P	173	Chord High-Back Chair	CO300	170	Bindu-Mid Back Executive Chair
798-PAU	173	Chord Midback Chair	CO300G	140	Bindu-Mid Back Guest/Side Chair
798AU	173	Chord Midback Chair	CO400	170	Bindu Mid-Back High Back Executive Chair
877102002SR	237	Master Lock Tool	CODAV	78	Davos Chair
877102003SR	237	Standard Lock Tool	CODAV16	78	Davos Small Bench
9014S	142	Stacking Dolly	CODAV38	78	Davos Medium Bench
BB48	45	Bix Bench	CODAV60	78	Davos Large Bench
BB72	45	Bix Bench	COEB2723H	184	Sebastopol 22" High Table
BBS48	45	Bix Bench	COEB2723L	184	Sebastopol 16" High Table
BBS72	45	Bix Bench	COEB4118H	184	Sebastopol 22" High Table
BL26AA	40	Bix Lounge Chair with Arms	COEB4118L	184	Sebastopol 16" High Table
BL26XX	40	Bix Lounge Chair	COEL100	146	Enea Lottus Armless Chair
BLB26XX	40	Bix Lounge Chair with Screen	COEL100INSERT	146	Enea Lottus Armless Chair
BLD26AA	41	Bix Sled Lounge with Arms	COEL100UPH	146	Enea Lottus Armless Chair
BLD26TX	41	Bix Sled Lounge Tablet Arm	COEL1830	179	Enea Lottus Occasional Table
BLD26XT	41	Bix Sled Lounge Tablet Arm	COEL1836	179	Enea Lottus Occasional Table
BLD26XX	41	Bix Sled Lounge	COEL1842	179	Enea Lottus Occasional Table
BSE54LX	42	Bix Sectional Seating	COEL200	148	Enea Lottus Cantilever Arm Chair
BSE54RX	42	Bix Sectional Seating	COEL200INSERT	148	Enea Lottus Cantilever Arm Chair
BSS48XX	42	Bix Sectional Seating	COEL200UPH	148	Enea Lottus Cantilever Arm Chair
BSS72XX	43	Bix Sectional seating	COEL300	149	Enea Lottus Aluminum Loop Arm Chair
BSSB48XX	42	Bix Sectional Seating	COEL300INSERT	149	Enea Lottus Aluminum Loop Arm Chair
BSSB72XX	43	Bix Sectional Seating	COEL300UPH	149	Enea Lottus Aluminum Loop Arm Chair
CO200G	140	Bindu-Low Back Guest/Side Chair	COEL3030	180	Enea Lottus Conference Table
CO2465	192	Emu Round Chair	COEL303072	183	Enea Lottus Rectangular Table
CO2465B	193	Emu Round Stool Cushion	COEL3036	180	Enea Lottus Conference Table
CO2465C	193	Emu Round Chair Cushion	COEL3042	180	Enea Lottus Conference Table
CO2466	192	Emu Round Arm Chair	COEL3624	181	Enea Lottus Café Counter-Height Table
CO2467	192	Emu Round Stool	COEL3630	181	Enea Lottus Café Counter-Height Table
CO2467B	193	Emu Round Stool Cushion	COEL363072	183	Enea Lottus Rectangular Table
CO2467C	193	Emu Round Stool Cushion	COEL3636	181	Enea Lottus Café Counter-Height Table
CO2469	192	Emu Round Lounge	COEL3642	181	Enea Lottus Café Counter-Height Table
CO2469B	193	Emu Round Lounge Cushion	COEL400	151	Enea Lottus Sled-Base Stool
CO2469C	193	Emu Round Lounge Cushion	COEL400INSERT	151	Enea Lottus Sled-Base Stool
CO2470	194	Emu Round Table	COEL400UPH	151	Enea Lottus Sled-Base Stool
CO2471	194	Emu Square Table	COEL4224	182	Enea Lottus Café Bar-Height Table
CO2472	194	Emu Square Table	COEL4230	182	Enea Lottus Café Bar-Height Table
CO2473	194	Emu Square Table	COEL423072	183	Enea Lottus Rectangular Table
CO2474	194	Emu Rectangle Table	COEL4236	182	Enea Lottus Café Bar-Height Table
CO2475	194	Emu Counter Table	COEL4242	182	Enea Lottus Café Bar-Height Table
CO2477	194	Emu Side Table	COEL500	150	Enea Lottus Sled-Base Stool
CO2485	188	Emu Heaven Chair	COEL500INSERT	150	Enea Lottus Sled-Base Stool
CO2486	188	Emu Heaven Arm Chair	COEL500UPH	150	Enea Lottus Sled-Base Stool
CO2487	188	Emu Heaven Lounge Chair	COEL600	153	Enea Lottus Post-Base Stool
CO2488B	193	Emu Heaven Lounge Pillow	COEL600INSERT	153	Enea Lottus Post-Base Stool
CO2488C	193	Emu Heaven Lounge Pillow	COEL600UPH	153	Enea Lottus Post-Base Stool
CO2493	190	Emu Heaven Round Table	COEL700	152	Enea Lottus Post-Base Stool
CO2493V	190	Emu Heaven Glass Top	COEL700INSERT	152	Enea Lottus Post-Base Stool
CO2494	190	Emu Heaven Round Table	COEL700UPH	152	Enea Lottus Post-Base Stool
CO2494V	190	Emu Heaven Glass Top	COELDOLLY	147	Enea Lottus Stacking Dolly
CO2495	189	Emu Heaven Pouf	COH350W27	144	Enea Wood Café Stool, Counter-Height

# Style Number Index *continued*

Style Number	Page	Description	Style Number	Page	Description
COH350W31	145	Enea Wood Café Stool, Bar-Height	COMFLB4	87	Millbrae 4-Seat Bench
COH352W27	144	Enea Wood Café Stool, Counter-Height Upholstered	COMFLLA1	83	Millbrae Lounge
COH352W31	144	Enea Wood Café Stool, Bar-Height Upholstered	COMFLLA2	84	Millbrae 2-Seat Lounge
COH353W27	144	Enea Wood Café Stool, Counter-Height	COMFLLA3	85	Millbrae 3-Seat Lounge
COH353W31	145	Enea Wood Café Stool, Bar-Height	COMFLLA4	86	Millbrae 4-Seat Lounge
COJHB100	138	Visalia Lounge	COMFLRA1	83	Millbrae Lounge
COJHB200	138	Visalia Lounge	COMFLRA2	84	Millbrae 2-Seat Lounge
COJHBC100	138	Visalia Lounge	COMFLRA3	85	Millbrae 3-Seat Lounge
COJHBC200	138	Visalia Lounge	COMFLRA4	86	Millbrae 4-Seat Lounge
COJHL100	137	Visalia Lounge	COMLPRND	87	Millbrae Round Arm Bolster
COJHL200	137	Visalia Lounge	COMLPSQR	87	Millbrae Square Arm Bolster
COJHL300	137	Visalia Lounge	COMSL1	83	Millbrae Lounge
COJHLC100	137	Visalia Lounge	COMSL2	83	Millbrae 2-Seat
COJHLC200	137	Visalia Lounge	COMSL3	83	Millbrae 3-Seat
COJHLC300	137	Visalia Lounge	COSFZCH	161	Montara650 Chair
COLAGB1	115	Lagunitas 1-Seat Bench	COSFZLC	163	Montara650 Lounge
COLAGB2	115	Lagunitas 2-Seat Bench	COSFZRC	167	Montara650 Rocker
COLAGB3	115	Lagunitas 3-Seat Bench	COSFZST	164-165	Montara650 Stools
COLAGCH2	108	Lagunitas 2-Seat Chaise	COTO12369L15	131	Together Bench
COLAGCH3	112	Lagunitas 3-Seat Chaise	COTO12369L8	131	Together Bench
COLAGCI	117	Alignment Connector	COTO12369R15	133	Together Bench
COLAGCL2	107	Lagunitas 2-Seat Chaise	COTO12369R8	132	Together Bench
COLAGCL3	111	Lagunitas 3-Seat Chaise	COTO12396L15	131	Together Bench
COLAGFN	119	Lagunitas Focus Nook	COTO12396L8	131	Together Bench
COLAGLBS	116	Lounge Booth Screen	COTO12396R15	133	Together Bench
COLAGLH11	91	Lagunitas 1-Seat Lnge w/ High-Bk Scrn	COTO12396R8	132	Together Bench
COLAGLH13	91	Lagunitas 1-Seat Lnge w/ HB Scrn, 2 Side Scrns	COTO69	135	Together Bench
COLAGLH21	95	Lagunitas 2-Seat Lnge w/ High-Bk Scrn	COTO69WB15	134	Together Bench
COLAGLH22	96	Lagunitas 2-Seat Lnge w/ HB Scrn, 1 Side Scrn	COTO69WB8	134	Together Bench
COLAGLH23	97	Lagunitas 2-Seat Lnge w/ HB Scrn, 2 Side Scrns	COTO96	135	Together Bench
COLAGLH31	103	Lagunitas 3-Seat Lnge w/ High-Bk Scrn	COTO9669L15	131	Together Bench
COLAGLH32	104	Lagunitas 3-Seat Lnge w/ HB Scrn, 1 Side Scrn	COTO9669L8	130	Together Bench
COLAGLH33	105	Lagunitas 3-Seat Lnge w/ HB Scrn, 2 Side Scrns	COTO9669R15	133	Together Bench
COLAGLL1	90	Lagunitas 1-Seat Lnge w/ Low-Bk Scrn	COTO9669R8	132	Together Bench
COLAGLL13	90	Lagunitas 1-Seat Lnge w/ LB Scrn, 2 Side Scrns	COTO9696L15	131	Together Bench
COLAGLL21	94	Lagunitas 2-Seat Lnge w/ Low-Bk Scrn	COTO9696L8	130	Together Bench
COLAGLL22	94	Lagunitas 2-Seat Lnge w/ LB Scrn, 1 Side Scrn	COTO9696R15	133	Together Bench
COLAGLL23	95	Lagunitas 2-Seat Lnge w/ LB Scrn, 2 Side Scrns	COTO9696R8	132	Together Bench
COLAGLL31	100	Lagunitas 3-Seat Lnge w/ Low-Bk Scrn	COTO96WB15	134	Together Bench
COLAGLL32	101	Lagunitas 3-Seat Lnge w/ LB Scrn, 1 Side Scrn	COTO96WB8	134	Together Bench
COLAGLL33	102	Lagunitas 3-Seat Lnge w/ LB Scrn, 2 Side Scrns	COURQL	81	Hosu Lounge w/Attached Lumbar
COLX200	156	Lox Stool	COURQLO	81	Hosu Lounge w/Otto and Attached Lumbar
COLX210	156	Lox Stool	COURQS	81	Hosu 2-Seat Lounge
COMF1	87	Millbrae Ganging Kit	COW210	127	SW_1 Ottoman
COMFL1	83	Millbrae Lounge	COW413	174	SW_1 Conference Chair
COMFL2	84	Millbrae Lounge	COW415	174	SW_1 Conference Chair
COMFL3	85	Millbrae 3-Seat Lounge	COW613	127	SW_1 Low-Back Collaborative Lounge Chair
COMFL4	86	Millbrae 4-Seat Lounge	COW713	127	SW_1 High-Back Collaborative Lounge Chair
COMFLA1	83	Millbrae Lounge	COWK100	66	Joel Lounge
COMFLA2	84	Millbrae 2-Seat Lounge	COWRP4LEG	168	Wrapp Chair, 4 Leg
COMFLA3	85	Millbrae 3-Seat Lounge	COWRPSLD	168	Wrapp Chair, Sled-Base
COMFLA4	86	Millbrae 4-Seat Lounge	LOCKFR	237	Lock Cylinder
COMFLB1	87	Millbrae 1-Seat Bench	LOCKXF	237	Lock Cylinder
COMFLB2	87	Millbrae 2-Seat Bench			
COMFLB3	87	Millbrae 3-Seat Bench			



# Style Number Index

# Trademark List

™/® The following is a non-exhaustive list of trademarks and registered trademarks for products of Steelcase Inc. or one of its related corporate entities: Agree, Airtouch, Alight, Amia, Answer, Aspekt, Avenir, Await, B-Free, Ballet, Bassline, Bindu, Bivi, Bix, Bottomline, Brody, Buoy, Cachet, Campfire, Capa, CF Series, CG\_1, Chord, Circa, Clipper, Cobi, Collaboration, Convene, Coupe, Cura, Currency, dash, Divisio, Duo, E-Table 2, Edge Series, Elbrook, Elective Elements, Embold, Empath, Everwall, Exponents, Folio, FrameOne, Gesture, Groupwork, Host, Hosu, i2i, Jenny, Kart, Kathryn, Kick, Lagunitas, Leap, Leela, LessThanFive, LiveBack, LiveSeat, Mackinac, Marien152, Max-Stacker, media:scape, Migration, Millbrae, Mineral, Mitra, Montage, Montara650, MoreThanFive, Move, Node, Ocular, Ology, Opus, Paperflo, Passerelle, Player, Pocket, Potrero415, QiVi, Radia, Regard, Relay, Reply, Ripple, Roam, Sarto, Scoop, Sebastopol, Senti Series, Senza, Shortcut, Sidewalk, Siento, Sieste, SILQ, Soffio, Sorrel, SOTO, Steelcase Eclipse, Steelcase Flex, Steelcase Karman, Steelcase Relay, Steelcase Rise, Steelcase Series, Surround, SW\_1, Switch, Sync, Tava, Tenor, Think, Thoughtful, Thread, Together, Train, Trees, Turnstone, Umami, Underscore, V.I.A., Verb, Verge, Verlay, Victor2, Visalia, WorkValet, and X-tenz.

™/® The following are trademarks or registered trademarks of AMQ Solutions, LLC: 3F, Activ, Amobi, Bixby, Bodi, Cluvo, Concur, Embank, FL-X, Iline, Jaku, Kinex, Personality Plus, Revi, S-Series, Siya, Tektis, Tizu, Uptake, and Zilo.

™/® The following are trademarks or registered trademarks of Orangebox Ltd., Cardiff, UK: Air3, Aspect, Avi, Away from the Desk, Border, Campers & Dens, Coppice, Cubb, Kim, On the QT, Ramsey, Skomer, Sully, Track-B, and Vale.

™/® The following are trademarks or registered trademarks of Viccarbe Habitat, S.L.: Aleta, Cambio, Designed in The Sun, Foro, Funda, Holy Day, Kelly, Last Minute, Noha, Savina, Sistema, Sistema, Viable, and Wrapp.

® The following are registered brands of Steelcase Inc. and its family of companies: Steelcase, AMQ, Coalesse, Designtex, Halcon, Orangebox, Smith System, and Viccarbe.

® The following registered trademarks are under license from AWI Licensing Company, Dover, DE: SoundScapes, DuraBrite, BioBlock, and Armstrong.

® The following registered trademarks are under license from Byrne Electrical, Rockford, MI: Interport, Mini-Port, Axil Z, and Ellora.

® The following is a registered trademark of DuPont, Wilmington, DE: Corian.

® The following is a registered trademark of Genlyte Thomas Company, Louisville, KY: Lightolier.

® The following is a registered trademark of Hilti Corporation, FL-9494 Schaan, Principality of Liechtenstein: Hilti.

® The following is a registered trademark of Leviton Manufacturing Company, Little Neck, NY: Decora.

® The following is a registered trademark of Mechanical Plastics Corp, Elmsford, NY: Toggler.

® The following is a registered trademark of Microsoft Corporation, Redmond, WA: Microsoft.

® The following are registered trademarks of Orangebox Ltd., Cardiff, UK: Orangebox.

® The following is a registered trademark of Panduit Corporation, Lockport, IL: Panduit.

® The following is a registered trademark of Trav (Press), Cuneo, Italy: Assisa.

® The following is a registered trademark of Virtual Ink, Boston, MA: mimioActive.

® The following registered trademarks are under license from Wilkhahn Furniture Products: Avera, Senzo, Versal, and Wilkhahn FS.

® The following are registered trademarks of Polyvision Corp: Flow, Motif, Polyvision, Sans, and Serif.

® The following is a registered trademark of Wilsonart International, Temple, TX: Chemsurf.

® The following is a registered trademark of Wiremold, West Hartford, CT: Wiremold.

® The following is a registered trademark of EMU Group S.P.A., Perugia, Italy: EMU.

® The following is a registered trademark of Security People, Inc.: Digilock.

® The following are registered trademarks of Natural Capital Partners Europe Limited: CarbonNeutral and the CarbonNeutral Certified logo.

™ The following is a trademark of Microsoft Corporation, Redmond, WA: Windows.

™ The following is a trademark of Rodman Industries, Inc., Oconomowoc, WI: ResinCore1.

™ The following is a trademark of Ultrafabrics, LLC, Elmsford, NY: Ultraleather.

™ The following trademarks are under license from Wilkhahn Furniture products: Cana, Linus, Logon, Picto, Range, Stitz, Thema, Timetable, and Tubis.

™ The following trademarks are under license from Walter Knoll: Andoo, Bob, Lazlo, Lox, Ribbon, and Together.

™ The following trademarks are under license from PP Möbler: Bar and Flag Halyard.

™ The following trademarks are under license from Carl Hansen: Elbow, Paddle, Shell, Wing, and Wishbone.

™ The following trademarks are under license from Cambridge Sound Management, LLC Cambridge, MA: QtPro Soundmasking, Qt Quiet Technology, and Sonet Qt.

™ The following is a trademark of Electri-Cable Assemblies, Shelton, CT: Interact.

™ The following is a trademark of Clestra Hauserman: IRYS.

™ The following is a trademark of Wiesner-Hager Möbel GmbH: Nooi.

™ The following are trademarks of Polyvision: Accord, a3, e3, Boundri, and Nota.

™ The following is a trademark of Bostock Company, Inc: SnapCab.

™ The following is a trademark of Williams-Sonoma, Inc: West Elm.

™ The following is a trademark of Elena Marquina Testor: nanimarquina.

™ The following is a trademark of Forbo International SA: Forbo.

Trademarks used herein are the property of Steelcase Inc. or their respective owners.